

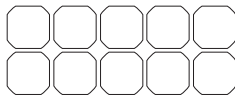

GKS-200 | User Manual



DISCLAIMER

Read all safety tips, warning messages, terms of use, and disclaimers carefully. Users take full responsibility for all usage and operations. Familiarize yourself with the related regulations in your area. You are solely responsible for being aware of all relevant regulations and using GENKIPWR products in a way that is compliant.

CONTENTS

1. Specifications	1
2. Safety Instructions	2
3. In The Box	3
4. How It Works	3
5. Speed Up Solar Charging	4
6. Solar Setup	4
7. Warranty	7

1. Specifications

General Info	GKS-200_20V	GKS-200_40V
Nominal Power	200W	
Cell Type	A-grade monocrystalline silicon solar cell	
Cell Efficiency	23%	
Maximum Power Current (Imp)	10A	5A
Maximum Power Voltage(Vmpp)	20V	40V
Open-circuit Voltage(Voc)	24V	48V
Short-circuit Current (Isc)	10.5A	5.25A
Maximum System Voltage	DC200V	
Output Tolerance	±5%	
DC Output-1	Direct output line+PV connector	
Cable	1: 14AWG*1.5m +PV connectors	1: 16AWG*1.5m +PV connectors
Working Temperature	-40°C- +85°C	
Net Weight	8.4kg	
Waterproof grade	IP65	
Folding size	635 x 564 x 45 mm	
Deployment size	2390 x 564 x 25 mm	
Life/ Warranty	10 years/ 2 years	

2. Safety Instructions

1. The solar panel should be placed in direct sunlight and adjusted to the appropriate angle to receive the maximum power generation effect.
2. This product is suitable for mobile energy storage devices with a rated voltage of DC 24-28V (solar charging protection function is required) or for charging batteries. However, do not directly connect the output terminals of the solar panels to charge the batteries. A solar charge controller must be installed to protect the batteries from overcharging or prevent uncontrolled damage to the solar panels/batteries and personnel after the reverse polarity connection. For integrated energy storage units, you can connect to the corresponding solar charging interface according to the requirements of the energy storage unit manufacturer.
3. If exposed to rainwater, it does not affect normal use. (Note: Do not contact seawater or other conductive/corrosive liquids, which can cause short circuit inside the junction box and failure to generate electricity normally. Rinse with clean water and air dry immediately if contacted.)
4. When connecting to a solar controller/integrated energy storage unit, pay attention to correctly connecting the positive and negative interfaces.
5. Before connecting to the solar controller/battery/integrated energy storage unit, carefully check its product specifications/power/current/voltage requirements and do not exceed its limits to avoid damage to the equipment and uncontrolled consequences.
6. The voltage of this device has exceeded the safe voltage for the human body under illumination. Do not directly contact or short circuit the device electrodes to prevent electric shock or safety hazards! If the solar panel is damaged, stop using it immediately to prevent electric leakage injury!
7. Handle with care during use. Do not apply heavy pressure, drop, hit or collide, otherwise the solar cells may be seriously damaged! Please let me know if you need any further clarification or have additional questions!

3. In The Box

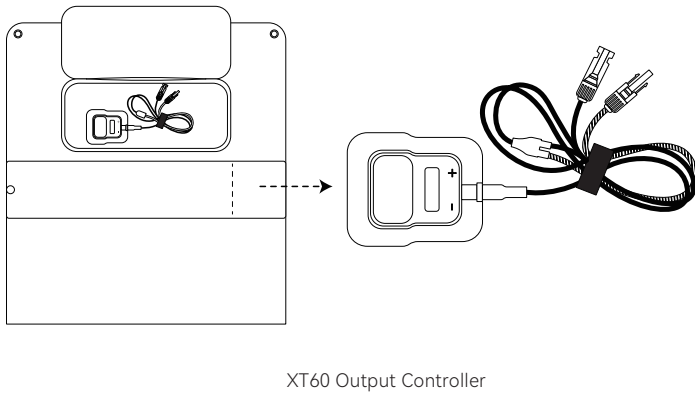
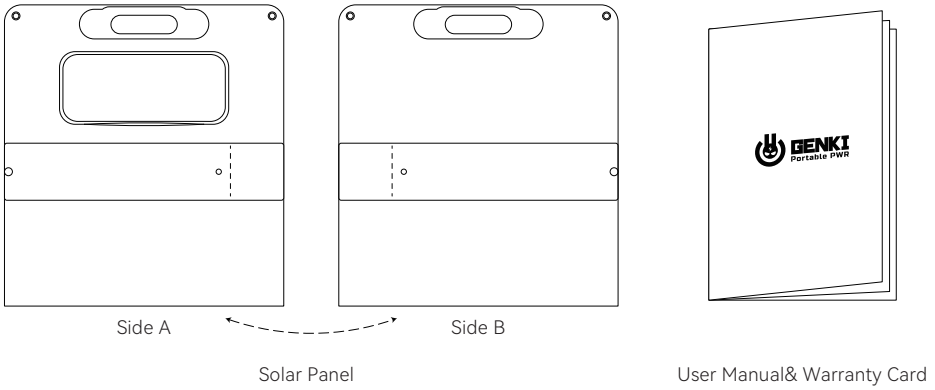

4. How It Works

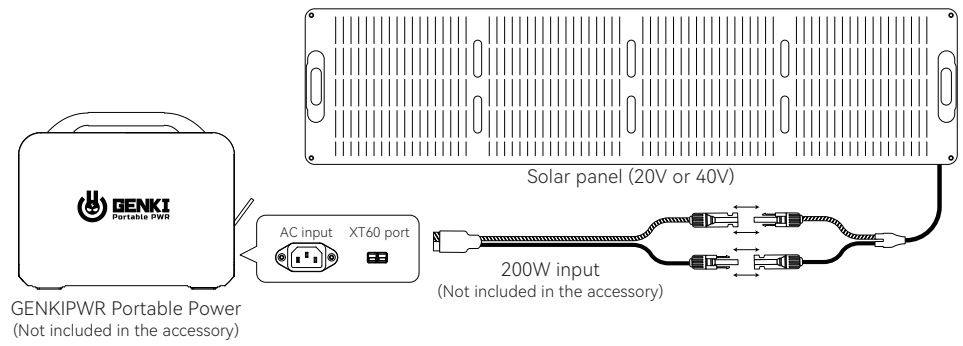

*Solar panel charging power refer to the weather and climate condition locally.

*The PV voltage exceeding 50V will damage the GENKIPWR and it will break warranty condition.

5. Speed Up Solar Charging

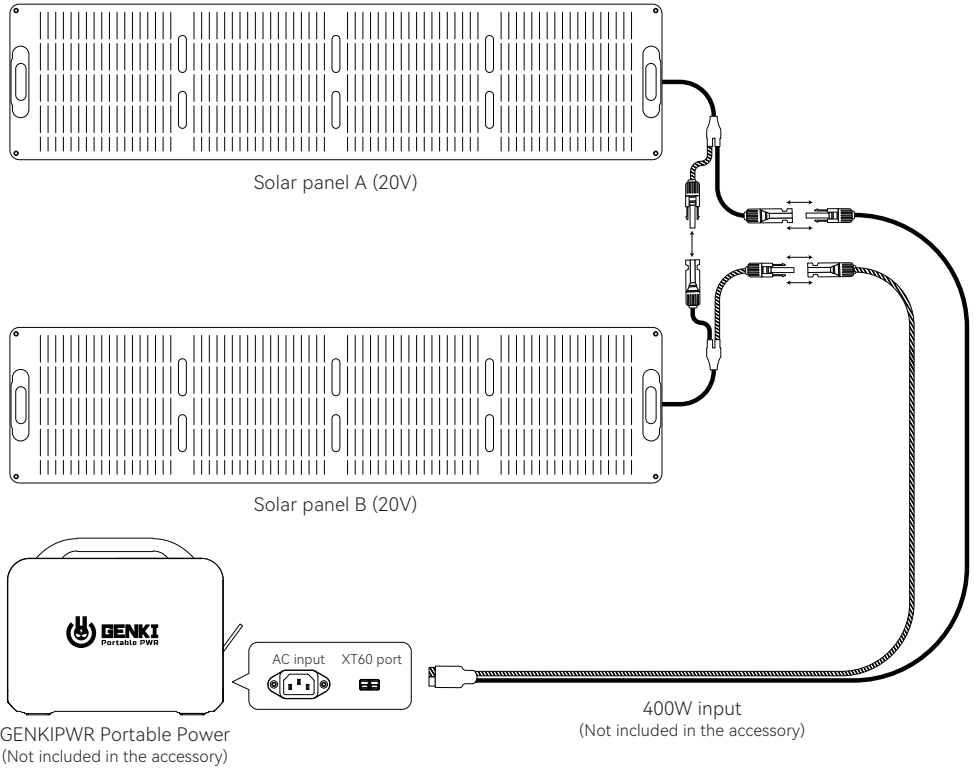

*Do not use three or more GKS-200 solar panels in parallel and connect them to GK-800/ GK-1200/GK-2000 and other GENKIPWR series products. The working voltage will exceed the limit.

6. Solar Setup

- ① Open the solar panel

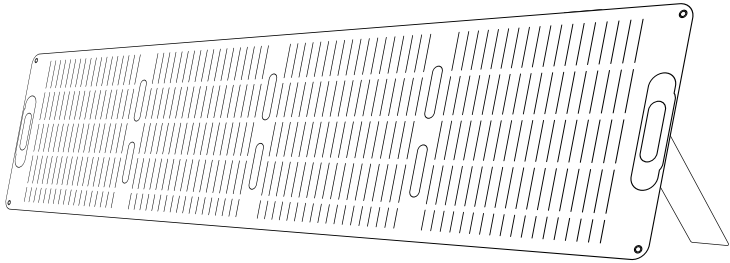

- ② Open the bracket to support the solar panel

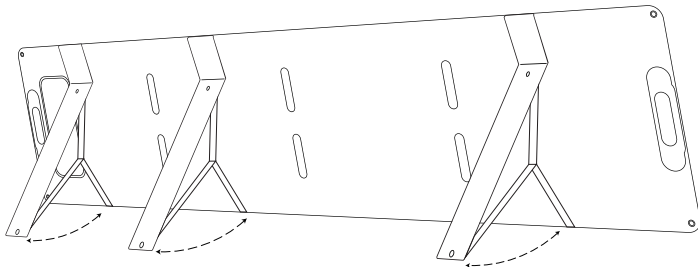

- ③ Connect GENKIPWR with cables

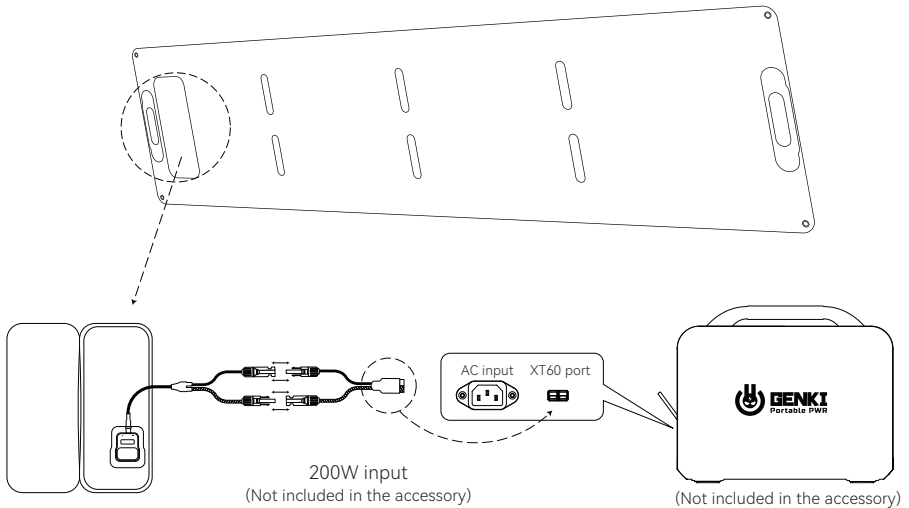

- ④ Adjust the angle of the solar panel to maximize sunlight absorption

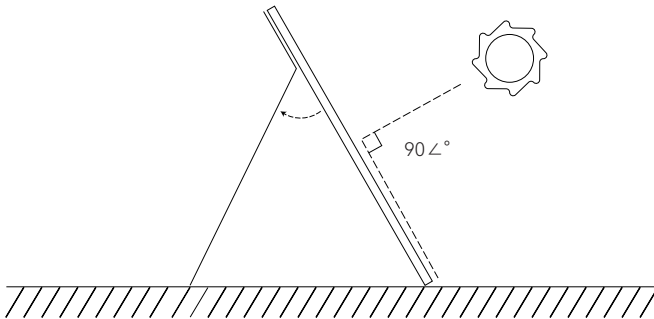
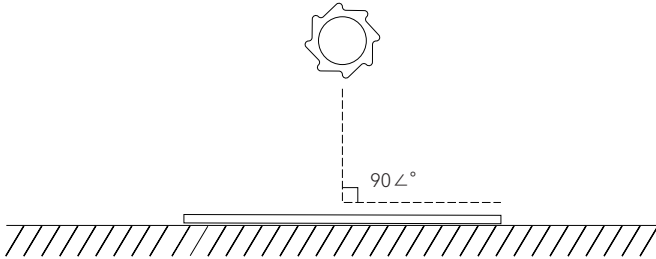

The performance of solar panels will vary depending on environmental conditions. The standard testing conditions are:

* Irradiance: $1000\text{W}/\text{m}^2$

* Temperature: 25°C

* AM: 1.5

* Power/Voltage/Current temperature coefficient: $-0.35\%/^\circ\text{C}$; $-0.272\%/^\circ\text{C}$; $+0.044\%/^\circ\text{C}$.

7. Warranty

1. Claiming a warranty requires your receipt, invoice, or order number. We may need to confirm your information.
2. GENKIPWR provides by default for each power station product a 2-year warranty from the date of purchase.
3. Free repair or replacement is provided within the scope of the warranty during the warranty period.
4. GENKIPWR also provides paid repair support for out-of-warranty products. However, consumables (such as cables) and discontinued products or parts cannot be handled.
5. During the warranty period, if a product is defective on arrival or the failure is caused by normal daily use, we will replace or repair the product free of cost.
6. During the warranty period, damage caused by the customer's fault, such as dismantling, intentional damage, improper use, etc., and damage caused by natural disasters are not suitable for free repair, only paid repair is provided, and we are not responsible for shipping costs for the situation above.
7. We cannot provide any kind of after-sales support for products purchased through non-official channels of the GENKIPWR brand or products with unknown buyers (such as resale products/second-hand products). In this case, please contact your seller for a warranty.
8. To apply for a warranty, please send an email to sales@dowellelectronic.com with the following information:

Name

Address

Email

Product Name & Model

S/N No (Usually on the package)

Order Number

Purchase Date (mm-dd-yyyy)

and Dealer Name. Also include a description of the failure or issue.

