



GK-1200 | User Manual



## **DISCLAIMER**

---

Read all safety tips, warning messages, terms of use, and disclaimers carefully. Users take full responsibility for all usage and operations. Familiarize yourself with the related regulations in your area. You are solely responsible for being aware of all relevant regulations and using GENKIPWR products in a way that is compliant.

# CONTENTS



<b>1. Specifications</b>	1
<b>2. Safety Instructions</b>	
2.1 Usage	2
2.2 Disposal Guide	3
<b>3. Getting Started</b>	
3.1 Product Introduction	4
3.2 Product Details	5
3.3 LCD Screen	6
3.4 Display Attention	6
3.5 UPS Mode	7
3.6 Solar Panel Connection	7
3.7 Car Charging	8
<b>4. FAQs</b>	9
<b>5. What's in the Box</b>	10
<b>6. Storage &amp; Maintenance</b>	10

# 1. Specifications

## General Info

Net Weight	Approximately 27.6lbs (12.5kg)
Dimensions	15.4in x 9.1in x 12.6in(39 x 23 x 32 cm)
Capacity	960Wh 48V 

## Output Ports

AC (x2)	Pure Sine Wave, 1200W total (Surge 2400W), 100V-120V (US、JP) /220-240V (EU) / 50Hz/60Hz
Max Device(s) Power Supported by X-Boost	1800W (Constant power)
USB-A (x2)	5V  2.4A, per port
Type-C-C1 (x3)	20W Max, per port
Type-C-C2(x1)	100W Max
Car Charger(x1)	12V  10A
DC Output (x2)	12V  3A, per port

## Input Ports

AC Charge	Rabbit Fast Charge 700W Max
AC Input Voltage	220-240V~ 50Hz/60Hz
Solar Charger	11.5-50V  12A, 500W Max
Car Charger	120W, 10A

## Battery Info

Cell Chemistry	LiFePO4
Cycle Life	3500 cycles to 80%+ capacity
Protection	Over Voltage Protection, Overload Protection, Over Temperature Protection, Short Circuit Protection, Low Temperature Protection, Low Voltage Protection, Overcurrent Protection

## Environmental Operating Temperature

Optimal Operating Temperature	20°C~30°C (68°F~86°F)
Discharge Temperature	-10°C~60°C (14°F~140°F)
Charge Temperature	0°C~55°C (32°F~131°F)
Storage Temperature	-20°C~45°C(-4°F~113°F) (optimal: 20°C~30°C(68°F~86°F))

\* Whether the product can be charged or discharged depends on the actual temperature of the battery pack.

## 2. Safety Instructions

### 2.1 Usage

1. Do not use the product near a heat source, such as a fire source or a heating furnace.
2. Avoid contact with any liquid. Do not immerse the product in water or get it wet. Do not use the product in rain or humid environments.
3. Do not use the product in an environment with strong static electricity/magnetic fields.
4. Do not disassemble the product in any way or pierce the product with sharp objects.
5. Avoid using wires or other metal objects that may result in a short circuit.
6. Do not use unofficial components or accessories. If you need to replace any components or accessories, please visit official GENKIPWR channels to check relevant information.
7. When using the product, please strictly follow the operating environment temperature specified in this user manual. If the temperature is too high, it may result in a fire or explosion; if the temperature is too low, the product performance may be severely reduced, or the product may cease to work.
8. Do not stack any heavy objects on the product.
9. Do not lock the fan forcibly during use or place the product in an unventilated or dusty area.
10. Please avoid impact, falls, or severe vibrations when using the product. In case of a severe external impact, turn off the power supply immediately and stop using the product. Ensure the product is well fastened during transportation to avoid vibrations and impacts.
11. If you accidentally drop the product into water during use, please place it in a safe open area, and stay away from it until it is completely dry. The dried product should not be used again, and should be properly disposed of according to Section 2.2 below. If the product catches fire, we recommend that you use the fire extinguishers in the following order: water or water mist, sand, fire blanket, dry powder, and finally a carbon dioxide fire extinguisher.
12. Use a dry cloth to clean off dirt on the product ports.
13. Rest the product on a flat surface to avoid damages caused by the product falling over. If the product is overturned and severely damaged, turn it off immediately, place the battery in an open area, keep it away from combustible matter and people, and dispose of it in accordance with local laws and regulations.
14. Ensure that the product is kept out of reach of children and pets.
15. Store the product in a dry and ventilated place.
16. It is recommended to use moisture barrier bags in wet environments (for example, places by the sea or waterways) to prevent the product from getting soaked. If water is found inside the product, it must not be used or turned on again. Please take anti-electric shock measures before touching the product. Following this, place the product in a safe, waterproof and open area. Once complete contact GENKIPWR Customer Service immediately.
17. This product is not recommended for powering medical emergency equipment related to personal safety, including but not limited to medical grade ventilators (hospital version CPAP: Continuous Positive Airway Pressure ), artificial lungs ( ECMO, Extracorporeal Membrane ) Please follow your doctor's instructions and consult with the manufacturer for restrictions on the use of the equipment. If used for general medical

equipment, please be sure to monitor the power status to ensure that the power does not run out.

18. When in use, power supply products will generate electromagnetic fields, which are likely to affect the normal operation of medical implants or personal medical equipment such as pacemakers, cochlear implants, hearing aids, defibrillators etc. If these types of medical equipment are being used, please contact the manufacturer to inquire about any restrictions on the use of such equipment. These measures are fundamental to ensure a safe distance between the medical implants (for example, pacemakers, cochlear implants, hearing aids, defibrillators etc.) and this product while in use.

## 2.2 Disposal Guide

1. If conditions permit, make sure that the battery is fully discharged before disposing it in a designated battery recycling bin. The product contains batteries with potentially dangerous chemicals, so it is strictly prohibited to dispose of it in ordinary trash cans. For more details, please follow the local laws and regulations on battery recycling and disposal.
2. If the battery cannot be fully discharged due to a product failure, please do not dispose of the battery directly in the battery recycling box. In such case, you should contact a professional battery recycling company for further processing.
3. Please dispose of over-discharged batteries that cannot be recharged.

# 3. Getting Started

## 3.1 Product introduction

This product is a 960Wh large capacity 1200W high power, 1.5 hours of high-speed charging portable energy storage power supply, using high safety performance of LiFePO4 battery.

It can be used as a backup power supply in case of emergency powercut, disaster, camping and vehicles, and can also provide power for various electric tools.

1200W high power, pure sine wave AC output, can be used for house-hold appliances such as dryers, microwave ovens, refrigerators, high-power induction cookers and it can also be used for other electronic devices such as personal computers.

Through the 700W ultra-fast charging, this model can be full charged within 1.5 hours, The AC input/output voltage frequency can automatic or manually switched between 50Hz/60Hz. This product also supports maximum 500W solar charging and allow you to charge even when the power cut or in outdoor situations.

## 3.2 Product Details

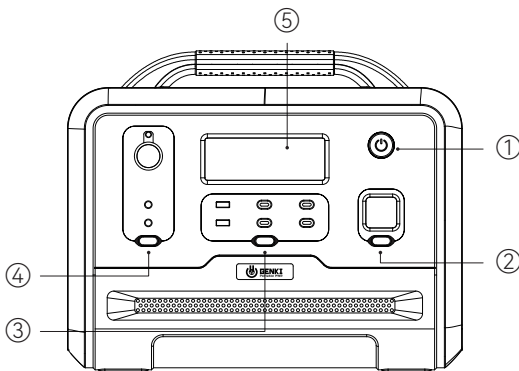

- ① Main power control
- ② Light control
- ③ USB control
- ④ DC control
- ⑤ LCD display
- ⑥ Air intake/outlet
- ⑦ AC on/off control (50Hz/60Hz switching )
- ⑧ XT60 input port (for solar panel)
- ⑨ AC input port
- ⑩ Overload protection

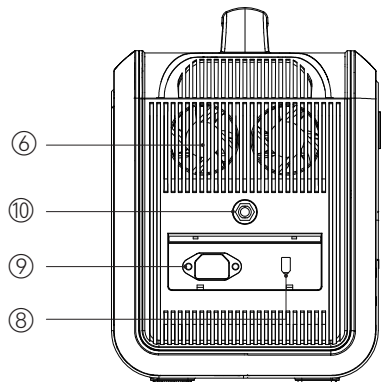
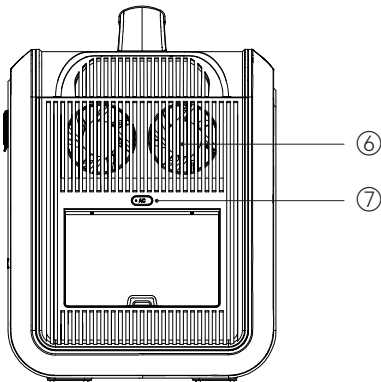



## ① Main Power Control

Main Control for the whole system turn on/off.

Operate method: long press the button for 3s to turn on/off the system.



## ② LED light control

Operate method: short press to turn on and change the light mode(SOS/Flash).

Notice: you can turn off the light by long press the button(1-2s) in any mode.



## ③ USB button

Operate method:short press to turn on/off.

 USB-A × 2 5V/2.4A	 TYPE-C × 1 PD-100W	 TYPE-C × 3 PD-20W
---	--	---

## ④ DC button

Operate method:short press to turn on/off.

 Output × 2 12V/3A	 Cigar Lighter × 1 12V/10A
---	---

## ⑤ LCD display

Present the remaining power and using data.

## ⑥ Cooling system

When the fans are working, please don't block the channel.

## ⑦ AC button(AC output, total share 1200W)

**Operate method: short press to turn on/off.**Notice:

1.Please confirm the output voltage or frequency before using

2.Long press the button for 3s to entry the frequency changing mode, 50Hz and 60Hz will blink in the display, press again the button to choose the right frequency. Wait till the frequency is not blinking, then you will get the frequency you want.

3.Quick short press for 10 times to switch the voltage 220V or 230V.

## ⑧ Solar panel input

**Use the included XT60-MC4 conversion cable to connect the solar panel.**

1.Solar panels can have a maximum input of 500W and a maximum voltage of 50V.

2.If exceeding the maximum voltage leads to equipment damage, it is beyond the scope of warranty.

## ⑨ AC input port

**Use wall socket to get 700W fast charging, which can full charge from 0 to 100% in 1.5 hours.**

\*The product can be charged directly by the wall socket, please do not use extension cords and cable taps, When the product is charging, do not plug other products in the same socket.

\*Please do not plug several devices together in a extension socket at once, the current will be too high and bring damage to the cable and fire risk.

\*Do not use the same socket to connect other devices when charging.

## ⑩ Overload protection

To protect this product, an overload protector is added. Prevent damage to the product due to excessive AC input current caused by lightning and power grid fluctuations. When such a situation occurs, the overload protector will start to cut off the AC input to protect the product

Restore the AC input function of the product in the following sequence.

1. Turn off the power button and unplug all ports.
2. After confirming that all parts are normal, turn on the power button.

## 3.3 LCD Screen

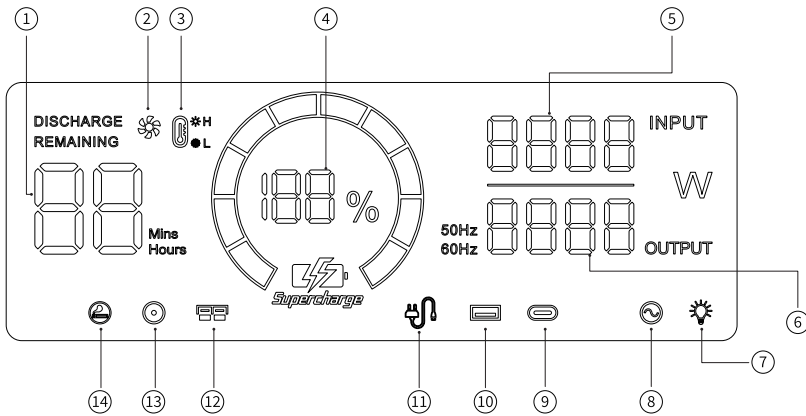

- |                              |                      |                        |                       |
|------------------------------|----------------------|------------------------|-----------------------|
| ① Charging/using time        | ⑤ Total input power  | ⑨ Type-C output        | ⑬ Type-C output       |
| ② Fan state                  | ⑥ Total output power | ⑩ USB output           | ⑭ Cigarlighter output |
| ③ H/L temperature protection | ⑦ LED light          | ⑪ AC charging          |                       |
| ④ Power percentage           | ⑧ AC output          | ⑫ Solar Charging Input |                       |

## 3.4 Display Attention



When this icon lights up. Please keep Air intake/outlet unobstructed.



When this icon lights up. Please note the device is now with high/low temperature and will possibly stop working till the temperature back to normal standard.



When this icon is blinking, represent that the AC input is fault, please recheck (Power/Hz/cable).



When the icon is blinking, represent the output is fault, please recheck.

## 3.5 UPS mode

### UPS function

GENKIPWR has the bypass mode, when charging, it directly supply power from AC to DC load without passing through the battery, when grid is off it can switch to DC-DC automatically and allow battery to discharge power to load continuously within 10ms.

### UPS Connections

As shown in the figure below, connect the product between the socket on the wall and the electrical appliances, and the power of the product is in the ON state. When you turn on the power of the electrical appliances, it will directly uses the AC power of the power grid.

In this state, when the power grid is cut off, it will automatically switch to the product's internal battery to supply power.

\*In UPS mode of The United States and Japan, the maximum power output of AC is below 1100W, and the AC output exceeds 1100W. The AC output icon "⚡" blinks indicating overload.

\*In UPS mode of the China, United Kingdom, Europe and South Korea , AC output of the maximum power below 1200W. AC output over 1200W, The AC output icon "⚡" blinks indicating overload.

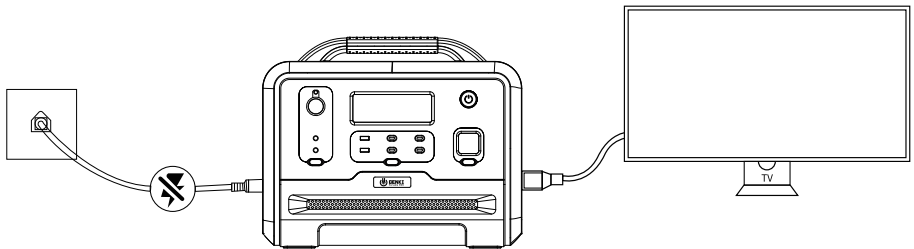

## 3.6 Solar panel connection

Our products can be connected to solar panels and can be charged through solar panels.

\*Solar panel charging power refer to the weather and climate condition locally.

\*The PV voltage exceeding 50V will damage the GENKIPWR and it will break warranty condition.

### By solar panels

#### Connecting Pattern ①

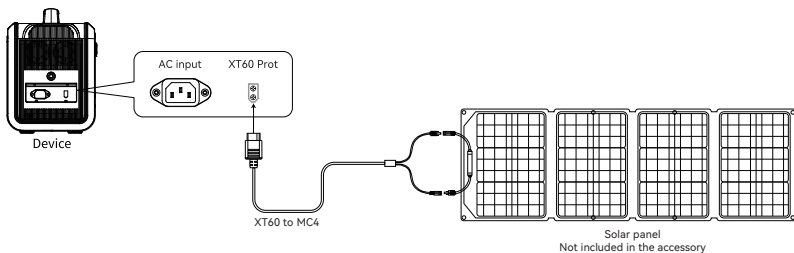

## By solar panels

### Connecting Pattern ②

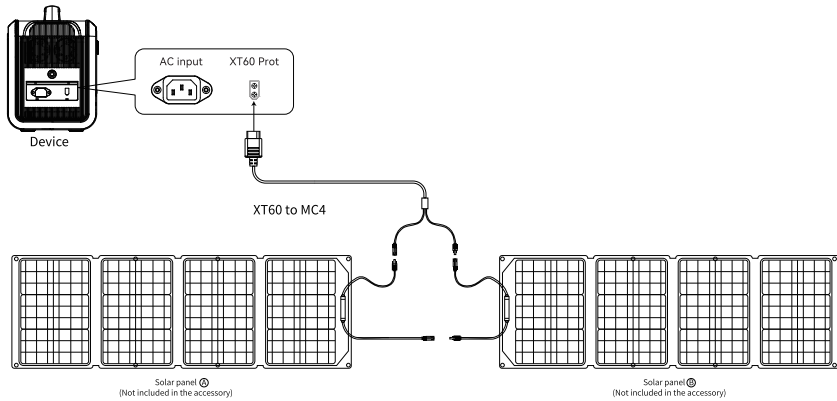

## 3.7 Car charging

This product can be charged by the cigarette lighter in the car with an ACC cable (accessory: ACC hereinafter).

Turn on GENKIPWR, connect the ACC charging cable to the cigarette lighter in the car and the XT60 interface on the side of the product, turn on the engine of the car, and the LCD of this product will show the input power.

\*On-board charging should be carried out with the car engine turned on, If the engine is not turned on, the battery might run out.

\*Car charging is usually low power of 90-120W, and the charging time will be long. If you need quick charge, it is recommended to use the mains.

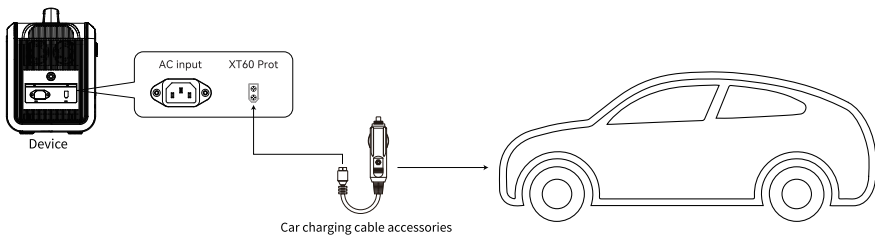

## 4. FAQs

### 1.What battery does the product use?

It uses high-quality LiFePO4 battery.

### 2. What devices can the product's AC output port power?

With 1800W constant power, the product's AC output port can power most household appliances. Before you use it, we recommend that you confirm the power of the appliances first and ensure the power sum of all loaded appliances is lower than the rated power.

### 3.How long can the product charge my devices?

The charging time is shown on the product's LCD Screen, which can be used to estimate the charging time of most appliances with stable power usage.

### 4.How can I know if the product is charging?

When it's charging, the remaining charging time will be shown on the LCD Screen. Meanwhile, the charging indicator icon begins to rotate with the remaining battery percentage and the input power shown on the centre of the circle.

### 5.How to clean the product?

Please gently wipe it with a dry, soft, clean cloth or paper towel.

### 6.How to store the product?

Before storing, please turn off the product first, and then store it in a dry, ventilated place at room temperature. Do not place it near water sources. For long-term storage, please discharge the battery to 30% and recharge it to 60% every three months to extend its battery life.

### 7.Can I bring GENKIPWR by air?

No.

## 5. What's in the Box

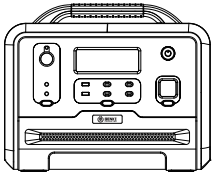

GK-1200

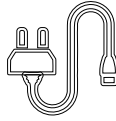

AC Charging Cable



User Manual



Car Charging Cable

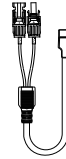

Solar Charging Cable

## 6. Storage & Maintenance

1. Ideally, use and store the product between 20°C to 30°C(68° to 86), and always keep it away from water, intense heat, and sharp objects. Do not store in temperatures above 60°C(140°F) or below -10°C(14°F) for an extended period.
2. Storing a battery with a low charge for a long period shortens its lifespan. This product mitigates the damage by putting the battery into hibernation mode. To get the most out of the battery, make sure it is about 60% before putting this product into long-term storage, and then once every three months, discharge the battery to 30% and recharge it back to 60%.