

SPRT®

SP-L31

Portable Thermal Printer

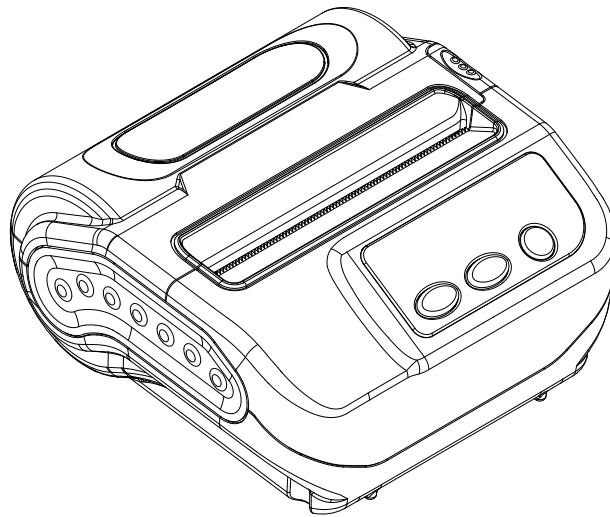

User's Manual
(ver 1.03)

Beijing Spirit Technology Development Co., Ltd

www.sprt-printer.com

CONTENTS

NOTICE.....	1
Notice of Safety.....	1
Notice of Using.....	1
Notice of Storing.....	2
Chapter 1 Outer Appearance and Model No.....	3
1.1 Outer Appearance.....	3
1.2 Model No.....	3
Chapter 2 Characteristic Specification.....	5
2.1 Printing Specification.....	5
2.2 Other Specification.....	6
Chapter 3 Operation Method.....	7
3.1 Using Preparation.....	7
3.1.1 Battery Installation.....	7
3.1.2 Paper Roll Installation.....	8
3.1.3 Others.....	9
3.2 Basic function usage.....	9
3.2.1 Switch On.....	9
3.2.2 Switch Off.....	10
3.2.3 Paper Feeding (Manual Feeding).....	10
3.2.4 Self-Test.....	11
3.2.5 Hexadecimal Printing.....	11
3.2.6 Printer Parameters Setting.....	11
3.2.7 Battery Charging.....	12
3.2.8 Enter Into Upgrade Mode.....	13
3.3 Printer Parameters Setting.....	13
3.4 Printer Interface Connection and Printing.....	13
3.4.1 USB Connection.....	13
3.4.2 Bluetooth Connection.....	14
3.5 Buzzer.....	15
3.6 LCD indication.....	15
Chapter 4 Other Information.....	17
4.1 Command Programming Manual.....	17
4.2 Description of Black Mark Pre-print.....	17
Appendix A.....	19
Appendix B.....	22

NOTICE

Please read this manual carefully before using the printer!

Notice of Safety

Be sure to use the specified battery and power supply provided by our company. Otherwise it may cause fire, explosion or damage printer, meanwhile, the battery also may be damaged.

Don't put battery into the fire, don't disassemble or heat the battery, don't be short circuit, it may cause fire, explosion or damage printer, meanwhile, the battery also may be damaged.

If the printer would not be used for a long time, be sure to take off the battery, otherwise the battery may leak liquid which is corrosive liquid, if improper operation causes battery leak liquid, and it paste in the skin or clothes, please rinse it by clean water, if paste in the eyes, please rinse them thoroughly by clean water and see a doctor. Please do not open the paper case cover when it is printing or just when printing is finished, do not touch the printer head with hand or body, overheat may cause scald.

Notice of Using

Pls do not print more than 1 meter receipt, or will cause damage to printer head .

Water or other liquid should not be spilled into the printer, also the printer should not be appeared in the rain, or else may cause printer damage. Please do not open the paper case cover when it is printing, otherwise the printer may work improperly. If printer is using USB connection to work, should not unplug the USB cable, or else some printing data may be lost. When printer is using bluetooth connection to work, the distance of communication should be within 10 meters, otherwise the printer doesn't print or prints rubbish codes. Too high (50°C) or too low (5°C) environment temperature and too high (85%) or too low (20%) environment humidity both effect the printing quality. The printer paper roll with poor quality or stored for too long time also may reduce the printing quality even damage the printer. Under the black mark detecting mode, the printer requires that the pre-printed black mark is accordant with the printing rule of black mark (please refer to details in Chapter 4.2), otherwise the black mark can not be detected correctly. Be sure to use up the power of the battery before charge up it, as it can ensure the using life of the battery.

Notice of Storing

The printer should be placed in such an environment that the temperature is

between-20°C and 60°C, and the relative humidity is between 10% and 95%. If the printer will be stored for a long time, please be sure to take out the battery, otherwise may damage the battery and printer.

Statement

This is a Class A product, which may cause radio interference in the living environment. In this case, users may need to take practical measures to interfere with it.

Chapter 1 Outer Appearance and Model No

1.1 Outer Appearance

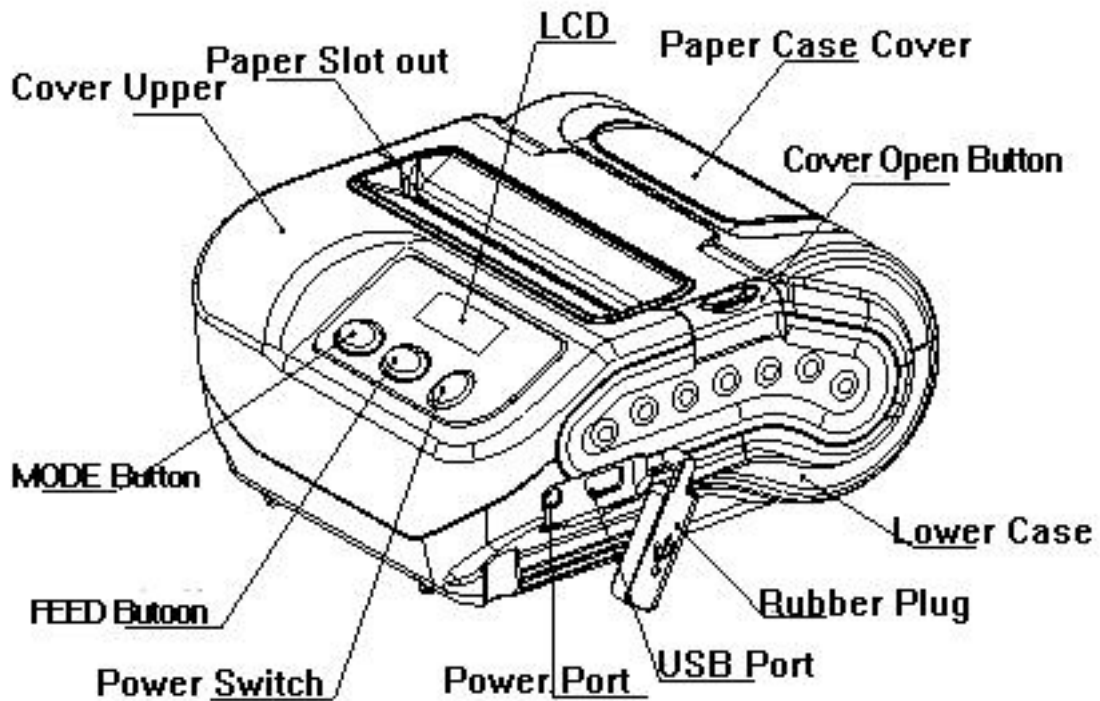

[CHARGE]: Battery Charging Indicator Indicator

[ERROR]: Error

[FEED]: Feed Button

[MODE]: Mode Button

1.2 Model No.

SP-L31/SP-L31BT4/SP-L31BTDM Support USB and Bluetooth Interface as default

Chapter 2 Characteristic Specification

2.1 Printing Specification

Printing Method: Thermal line

Paper Width: 79.5mm±0.5mm, 57.5±0.5mm, 44±0.5mm

Effective Printing Width: 72mm, 48mm, 37.5mm;

Resolution: 8dots/mm(203dpi)

Dots in each line: 79.5mm: 576dots/line

57.5mm: 384dots/line

44mm: 300dots/line

Printing Speed: 80mm/s (thermal paper), 67mm/s (label paper)

Paper Thickness: 0.06mm~0.08mm(thermal paper) and 0.06-0.15mm (label paper)

Printable Content:

Character set: GB18030(Chinese) BIG5(traditional Chinese), GB12345(traditional Chinese), Shift+JIS(Japanese), ASCII, Self-defined character and figure

Barcode:

1D:UPCA,UPCE,EAN13,EAN8,CODE39,ITF25,CODABAR,CODE93,CODE 128

2D: PDF417,QR CODE,DATA Matrix

2.2 Physical Parameters

Dimension (W×L×H): 105(L) X109(W) X51(H) mm

Physical Weight: 360g (excluding roll paper)

Paper Width: 80mm, 58mm and 44mm

Paper Roll Diameter: Max 40.0mm

Interface: USB, Bluetooth

Printing Head Life: 50km

2.3 Environmental Parameters

Operating Temp: 0°C~50°C

Operating Humidity: 10%~80%

Storage Temp: -20°C~60°C

Storage Humidity: 10%~90%

2.4 Other Specification

- Paper Loading Method: Easy Paper Loading
- Paper Tear: Manual Paper Tear
- Black Mark Location: available(details please see 4.2 pre-printed black mark manual).
- Printing Control Command: ESC/POS compatible command set, CPCL

command set,

(Refer to <SP-L31 Printer Command Program Manual > for details).

- Power Supply: 7.4V/1400mAh rechargeable polymer lithium battery.
- Low Power Alarm: When the electric of battery will run out, the battery icon on the printer screen will flash.
- Auto-sleeping: the printer will fall into sleep after in 5 seconds without button operation or receiving data , and can be awoken by pressing 【FEED】 button, 【MODE】 button or sending data to it.
- Battery Charging: quick charging, it will be fully charged about 2 hours;
- Battery Duration: under 25% printing density, more than 200 meters; the standby time is over 4days. (These parameters are just for reference. Long term usage will cause the capacity decline, and can not ensure the time of printing.)

Chapter 3 Operation Method

3.1 Using Preparation

3.1.1 Battery Installation

1. Put the battery into the battery slot from the side with pins and press the other side into case. (as below Pic.)

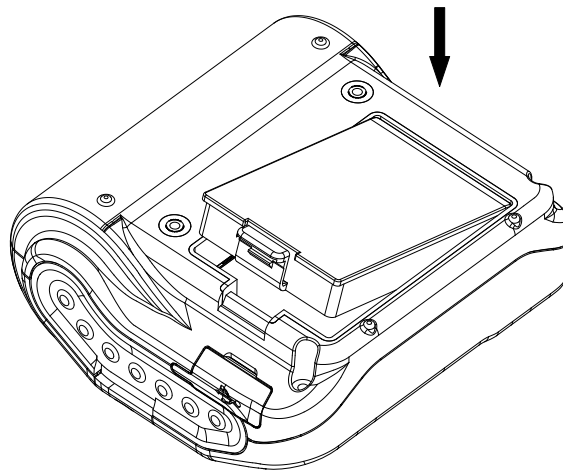

3.1.2 Paper Roll Installation

1. Hold both sides of the paper case cover, and open it. (Pic.1)
2. Pay attention to use paper that effective printing side is outside in the

printing paper face when you install the new paper roll. (Pic.2)

3. Pull out a part of paper and put them in the middle of the paper out orifice.
(The end of paper is beyond the tear cutter.)

4. Shut down paper case cover and cut off the redundant paper

5. Use the Optional Paper Holder (80mm/58mm/44mm), put paper roll with different width into the holder accordingly. (Pic. 3)

6. Repeat Steps 3~4.

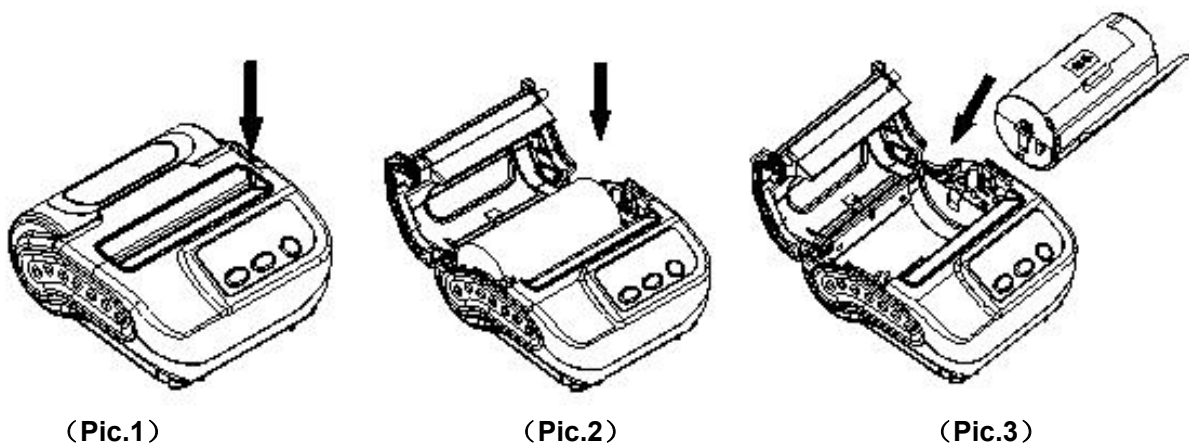

3.1.3 Others

Open and close the door instruction: When closing the door, insure to close right and left side at the same time.

Abnormal operation instructions: Paper blocking is not allowed at the outlet.

Placement direction: Hand-held flat printing when printing, to ensure the stability of the paper roll as far as possible.

3.2 Basic function usage

Printing Mode: Standard Mode and Logistics Mode.

Paper Type: Thermal paper, Black mark paper and Label paper.

Logistics Mode: Way Bill online mode, Receipt online mode, Invoice online mode. Label paper (79.5mm width) as default under Way bill mode. Receipt

paper (58mm width) as default under Receipt mode. Black mark paper (44mm width) as default under Invoice model.

Standard Mode: Standard 80mm mode, Standard 58mm mode, Standard 44mm mode. Standard thermal paper as default under Standard mode. Set the Printing mode and Paper type by Setting Tool (Way Bill mode and Invoice mode)

3.2.1 Switch On

Press **【POWER】** button about 1 second later you will hear 'one low one high 'prompt tone. The LCD shows "Loading...", then the printer turns into work mode when loosen the **【POWER】** button. The LCD shows printer parameter.

3.2.2 Switch Off

Under status of switch on,the printer will send out the prompt tone of 'one low one high ' after pressed the **【POWER】** button for 1 second, the LCD turns off, then loosen the **【POWER】** button, the printer is off.

3.2.3 Paper Feeding (Manual Feeding)

A. Standard Mode:

Under the normal work status and apply to thermal receipt paper, press **【FEED】** button, the paper feeding begins, and stop when loosen **【FEED】** button. When the printer apply to black mark paper and label paper, press **【FEED】** button, the printer begins to feed paper and stops over the position of black mark/label spacing. If the paper is not the black mark/ label paper, the printer stops automatically after feeds paper for 30cm. And alarm the error of paper end for label paper.

B. Logistics Mode:

Under the normal work status and apply to receipt, press **【FEED】** button, the paper feeding begins, and stop when loosen **【FEED】** button. When the printer apply to invoice and waybill, press **【FEED】** button, the printer begins to feed paper and stops over the position of black mark/label spacing. If the paper is not the black mark/ label paper, the printer stops automatically after feeds paper for 26cm. And alarm the error of paper end for waybill.

3.2.4 Self-Test

After receiving the printer, user can check its current setting and status at anytime.

Self-test way is as below: Power off, then hold down the **【FEED】** button and press the power button at the same time. Then loosen the **【FEED】** button when you hear 'one low one high 'prompt tone and LCD shows "Loading...", the

current setting and status will be printed out.

3.2.5 Hexadecimal Printing

The function of hexadecimal printing is to print the information received from host machine by hexadecimal numbers and corresponding characters. It will be convenient to debug application.

Into hexadecimal printing: Power off, hold down the **【MODE】** button and press the power button at the same time. Then loosen the power button and press the **【FEED】** button when you hear 'one low one high' prompt tone of power on and LCD shows "Loading...". After that you may loosen the **【MODE】** button and **【FEED】** button. The printer turns into the hexadecimal printing mode and print the presentation.

Quit hexadecimal printing :The way to quit hexadecimal printing mode is switch off the printer or press the **【FEED】** button for three times. The printer will also print the presentation which shows that the printer have quit hexadecimal printing mode.

3.2.6 Printer Parameters Setting

This function may set some simple printing parameters. There're two methods of entering into parameter setting mode, which can set different parameters.

A. Under the state of power off, hold down the **【FEED】** button and press the **【POWER】** button at the same time. Then loosen the **【POWER】** button and **【MODE】** button orderly when you hear 'one low one high prompt tone and LCD shows "Loading...". The printer turns into the parameters setting mode. Press the **【FEED】** button or **【MODE】** button, LCD shows the first item which can be set parameters and the current numerical value. (Refer to Appendix A.)

Quitting parameter setting: Hold down **【MODE】** and **【FEED】** buttons, then loosen **【MODE】** button and **【FEED】** button. Saving the set parameter and exiting the parameter setting mode. The setting parameters won't be saved if you directly press the **【POWER】** button to turn off the printer.

B. Under the state of standby power, press the **【MODE】** button to enter the parameter setting mode. Use the **【MODE】** button to select the setting parameter item, and use the **【FEED】** button to select the sub-menu of parameter item.(Refer to Appendix B.)

Wait for 5 min. to save parameters value automatically.

3.2.7 Battery Charging

The battery will run out after a period of usage. When it nearly runs out, printer will give a alarm through the battery indicator flashing on LCD, at this time, user needs to charge up the battery

The charging method is as following: connecting the adapter to the power socket with 220V, 50HZ, then plug the power charging plug to the power socket of the printer, so the power charging begins. During the course of power charging, the charging indicator 【CHARGE】 goes red, and【CHARGE】 turns to blue when the charging is full. Please don't use printer when it's charging.

3.2.8 Enter Into Upgrade Mode

In the shutdown state, press the [MODE] key and [FEED] key at the same time, press the [power] key. When hearing the `one low one High'boot prompt sound, quickly release the pressed button, and the printer enters the program upgrade mode. At this time, LCD display upgrade mode.

Note: Only USB interface supports online program upgrade.

3.3 Printer Parameters Setting

Users can set more parameters by using the specified 〈SP-L31 Setting Tools〉 software through computer. The setting includes: language、 font、 printing density、 default code page、 Bluetooth device name and password, printing mode etc. The setting method please refer to the <SP-L31Setting Tools Software Help>, offered with the software together.

3.4 Printer Interface Connection and Printing

3.4.1 USB Connection

The SP-L31 printer of standard accessories includes Mini USB cable which connects printer and main device. The USB type belongs to the slave device type. Pins description of Mini-USB as below:

Pin	Function	Notes
1	V Bus	Power +5V
2	Data-	
3	Data+	
4		Blank
5	GND	Ground



3.4.2 Bluetooth Connection

The devices, such as Hand-held device, laptop and other information terminal devices with Bluetooth can drive SP-L31 to print by the Bluetooth interface. SP-L31 portable printer is compatible with Bluetooth2.0 standard and dual Bluetooth(IOS Bluetooth 4.0 and Android Bluetooth 2.0) . Power class is CLASS 2, effective communication distance is 10meters. The Bluetooth of the printer belongs to the slave device. The initial name of the printer is SP-L31 BT Printer, the initial password is '1234'; users can change the printer name and password by using<SP-L31 Setting Tools> software. Please see the details in help file of <SP-L31 Setting Tools>.

Before working, SP-L31 Portable Thermal Printer need to be pairing with primary device, matching begins with the host device. Usual matching course is as below:

1. Switch on printer;
2. Host device searches for the outer Bluetooth device;
3. If there are other Bluetooth devices, please select SP-L31 Printer;
4. Enter the password '1234';
5. Pairing finished.

Please see details in primary device Bluetooth function instruction for reference.

Notice:

- 1, When pairing, please make SP-L31 BT switch on.
2. Once SP-L31 has paired with the host successful, it can't be paired with

other Bluetooth device until it unconnected with the host.

3, The power indicator flashing after paired successful. Printer LCD shows the connection state.

3.5 Buzzer

There is also a buzzer to indicate various status of the printer. The meanings are as below:

One low one high: power on;

One high one low: power off;



Circulation continuous two lows: printer at mistakes status

3.6 LCD indication

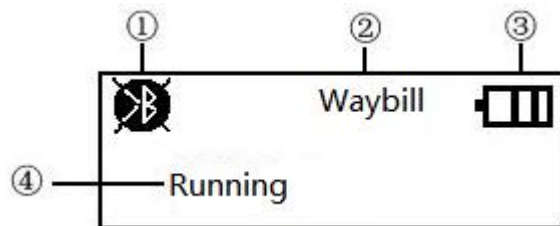

Turn on the printer, the LCD shows “Loading...”, and shows the relevant information after printer initialization. If printer didn't receive any data or connect with any device within 5 min., the display will turn off showing automatically. But it'll show again until printer receive data or connect with device.



Logistics mode:

① When the icon is , it means there's no Bluetooth connection; When the icon is , it means the Bluetooth is on connecting state.

② It shows the different printing modes, waybill online model, receipt online mode, and invoice online mode.





③ The current capacity level of printer battery icon. The different icons  shows the current battery level. When it comes to low battery level and need to charge, it'll become to show this icon  with flickering

④ Printer current state is showed by text.

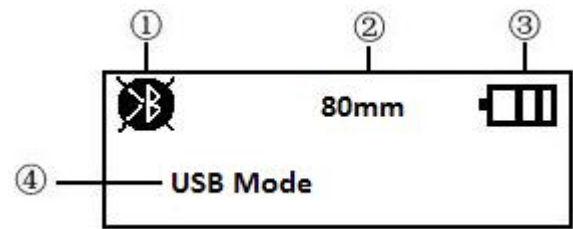
It shows running when the printer working normally.
 It shows printing when the printer received data.
 It shows paper end, abnormal temperature, abnormal volage or cover open alarm according to the printer working errors when printer work.

B. Standard mode:



- ① When the icon is , it means there's no Bluetooth connection; When the icon is , it means the Bluetooth is on connecting state.
- ② It shows the different paper type, 80mm, 58mm and 44mm.
- ③ The current capacity level of printer battery icon. The different icons  shows the current battery level. When it comes to low battery level and need to charge, it'll become to show this icon  with flickering
- ④ Printer current state is showed by text.
 - It shows USB connected when the printer connect with main device via USB.
 - It shows USB communicating when the printer received data via USB connection.
 - It shows Bluetooth connected when the printer connect with main device via Bluetooth and open the COM port.
 - It shows USB and Bluetooth connected when the printer connect with main device via both Bluetooth and USB.
 - It shows Bluetooth communicating when the printer received data via Bluetooth connection.

Chapter 4 Other Information

4.1 Command Programming Manual

<SP-L31 Technical Manual> is a technical manual for engineer to develop printer utility, and users can claim our company for it.

4.2 Description of Black Mark Pre-print

If user use pre-print black mark to locate the receipt, please be sure to abide by the following black mark pre-print regulation when print the black mark paper, if not ,it will cause that the printer can not identify the black mark.

The black mark pre-print regulations are as below:

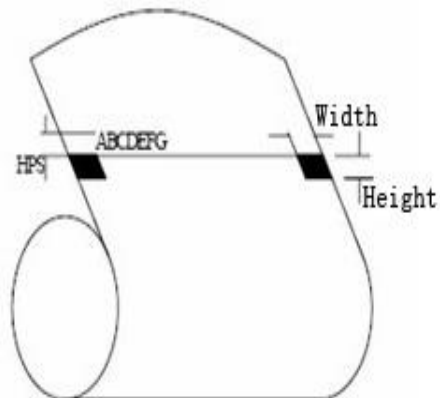

Printing Position: As the picture above, the black mark should be printed on the right or left edge of the side of words.

Width range: $\text{width} \geq 7\text{mm}$

Height range: $4\text{mm} \leq \text{height} \leq 6\text{mm}$

Reflectivity of infrared ray : $< 10\%$ (infrared ray reflectivity of other parts of the black mark paper is $> 65\%$)

HPS: it is the distance between edges of black mark and loading position.

$4.5\text{mm} \leq \text{Hps} \leq 6.5\text{mm}$

Appendix A

Setting introduction:【MODE】button is “set” button, when press it once , the set become the next one and it will print the present set value; 【FEED】 button to set the set value, when press it once , the set become the next one and it will print the present set value.

After setting, press【MODE】and【FEED】button together, it'll save the current value, and printer enters into normal operation state. Or it won't save the value.

General Setting:

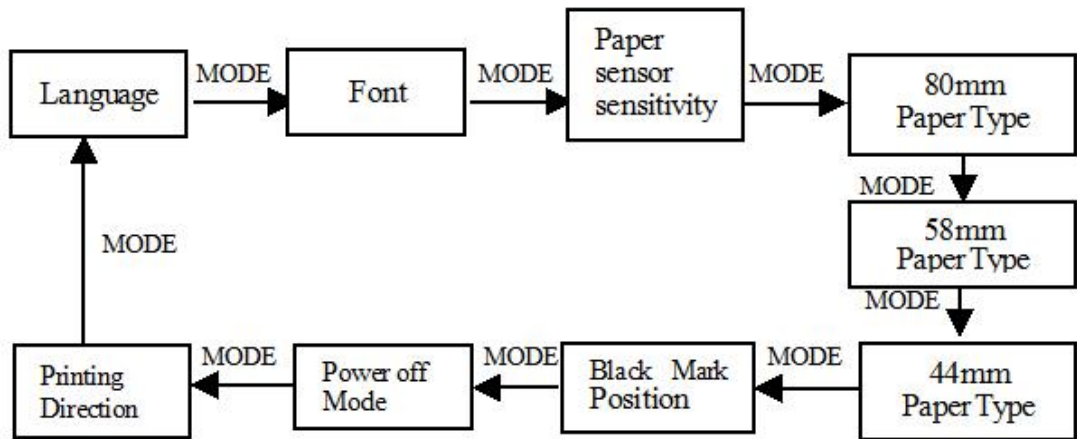

Language Setting:

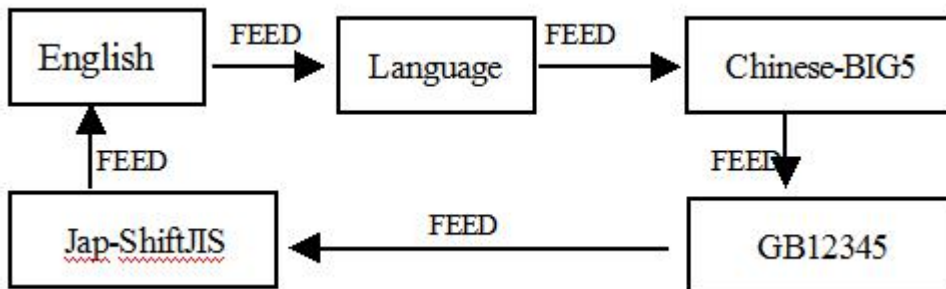

Font

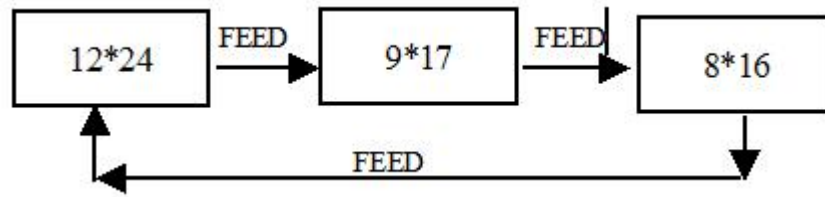

Setting:

Paper sensor sensitivity Setting:

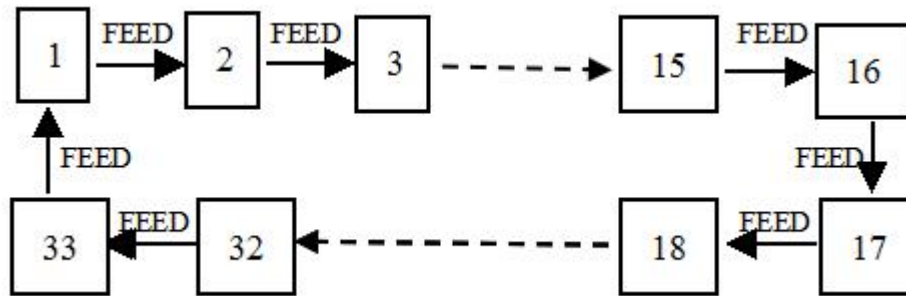

80mm/58mm/44mm Paper Type Setting:

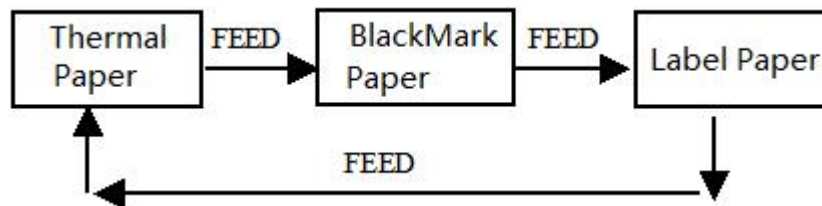

Black Mark Location Setting:

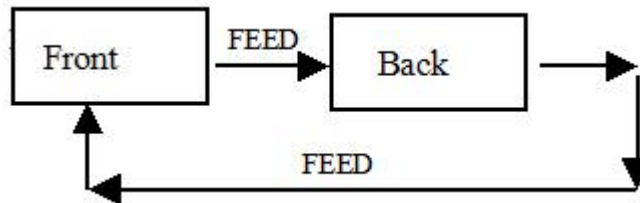

Power off Setting:

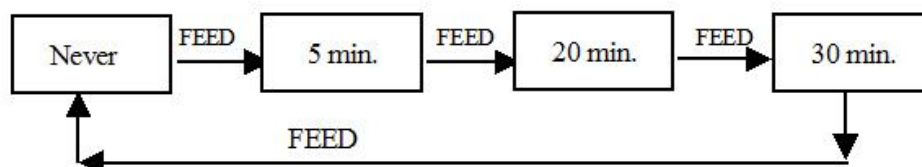

Printing Direction Setting:

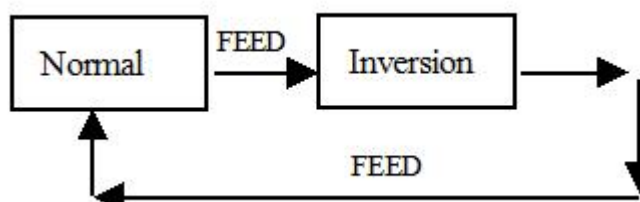

Appendix B

Setting introduction: 【MODE】 button is SET button, when press it once, the set become the next one and it will print the present set value; 【FEED】 button to set the set value, when press it once , the set become the next one and it will print the present set value.

After setting, it'll quick the Setting mode automatically and save the current value after 5 min.

General Setting:

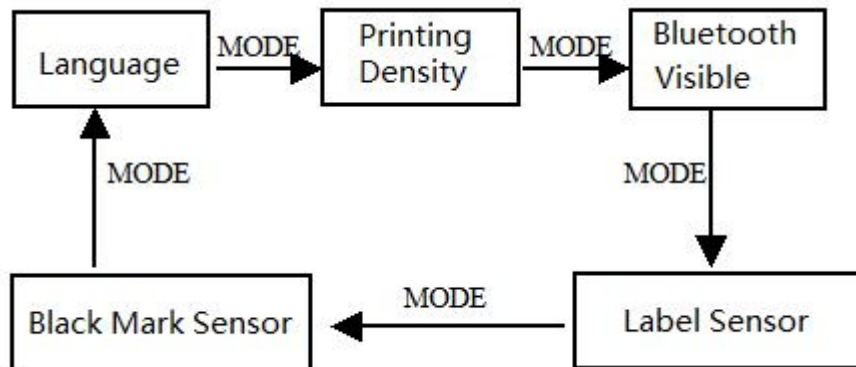

Language Setting:

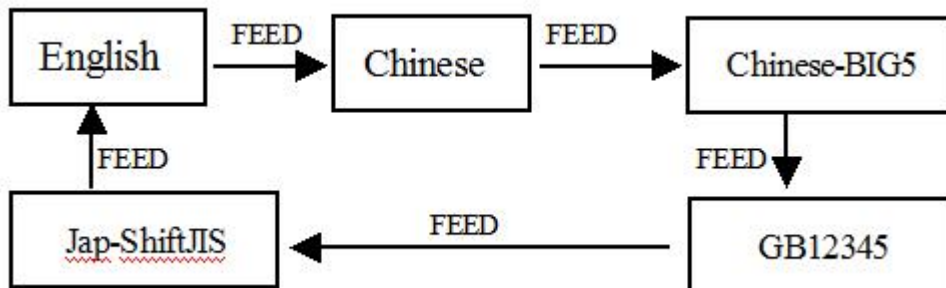

Density Setting:

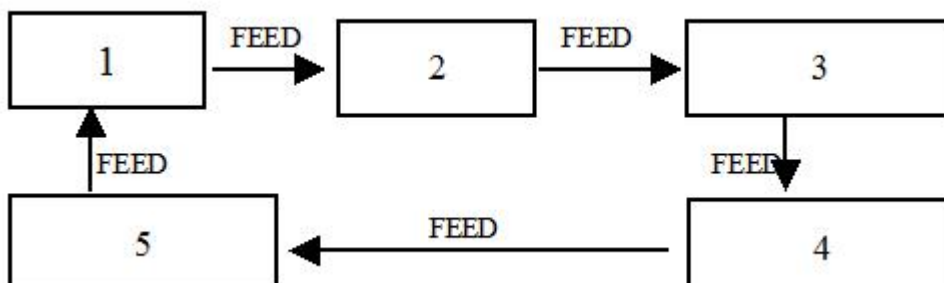

Visible Bluetooth Setting:

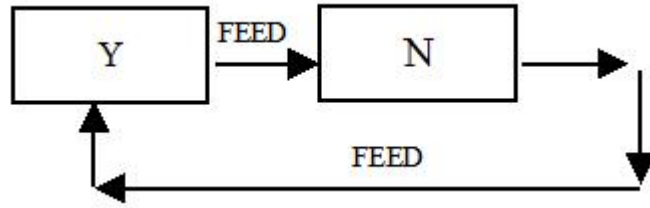

Label Sensor Setting:

Put the 80mm label paper directly into printer under Logistics mode (set as label paper under Standard mode) . Press **【MODE】** , adjust the setting items to label sensor setting, then press **【FEED】** , the printer will feed paper by 260mm, and print out the self-test paper for max power voltage, min voltage, set threshold voltage and the voltage difference between the max and min voltage. It'll save the value after 5min.

Black Mark Sensor Setting:

Put the 44mm black mark paper directly into printer under Logistics mode (set as black mark paper under Standard mode) . Press **【MODE】** , adjust the setting items to black mark sensor setting, then press **【FEED】**, the printer will feed paper by 260mm, and print out the self-test paper for max power voltage, min voltage, set threshold voltage and the voltage difference between the max and min voltage. It'll save the value after 5min.

Manufacture has right to amend the content of the instruction without prior announcement!