

SPRT®

SP-RME3

Thermal Panel Receipt Printer

USER MANUAL

V1.02

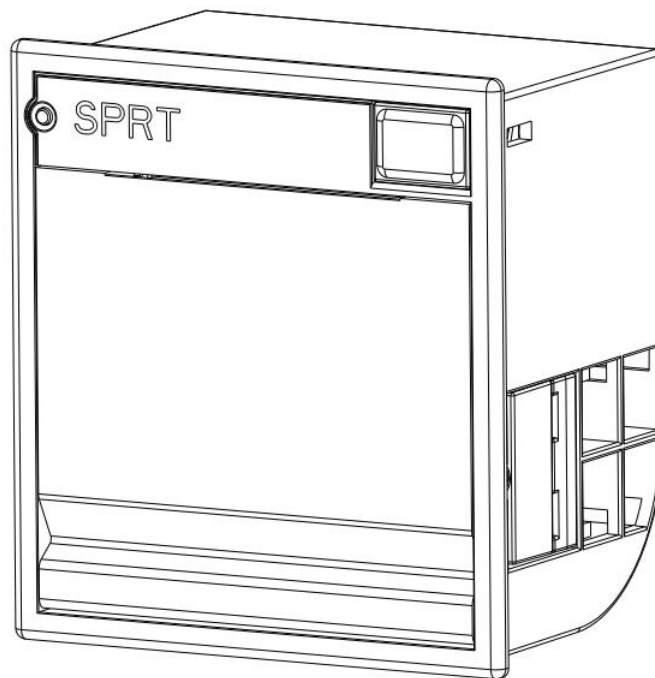

Beijing Spirit Technology Development Co.,Ltd
www.sprt-printer.com

Statement

This is a Class A product, which may cause radio interference in a living environment.

In this case, the user may need to take practical measures to interfere with it.

CONTENT

Chapter1 Outer Appearance and Dimension.....	1
1.1 Outer Appearance.....	1
1.2 Outline Dimension.....	1
Chapter2 Interface Definition and Description.....	3
2.1 Serial Interface Appearance.....	3
2.2 Pin Definition of Serial Interface.....	3
2.3 Parallel interface appearance.....	5
2.4 The pin definition of parallel port.....	5
2.5 USB interface.....	6
2.6 Power Port.....	7
Chapter3 Characteristic Specification.....	7
3.1 Printing capability.....	7
3.2 Power Supply.....	7
3.3 Paper Specification.....	7
Chapter 4 Operating instruction.....	8
Notice when operating:.....	8
4.1 Button and indicator description.....	8
4.2 Self-Test.....	9
Chapter 5 Printing Command.....	10
HT.....	10
LF.....	10
FF.....	11
CR.....	11
DLE EOT n.....	11
ESC SP n.....	13
ESC ! n.....	14
ESC \$ nL nH.....	15
ESC % n.....	15
ESC & y c1 c2 [x1 d1...d(y × x1)]...[xk d1...d(y × xk)].....	16
ESC * m nL nH d1... dk.....	18
ESC - n.....	20
ESC 2.....	21
ESC 3 n.....	21
ESC = n.....	21
ESC ? n.....	22
ESC @.....	22
ESC D n1...nk NUL.....	23
ESC E n.....	23
ESC G n.....	24
ESC J n.....	24
ESC M n.....	24

ESC R n.....	25
ESC \ nL nH.....	25
ESC a n.....	26
ESC c 5 n.....	27
ESC d n.....	27
ESC t n.....	27
ESC { n.....	29
FS P n.....	30
GS ! n.....	30
GS * x y d1...d(x × y × 8).....	31
GS / m.....	32
GS B n.....	33
GS H n.....	34
GS L nL nH.....	34
GS P x y.....	35
①GS V m ②GS V m n.....	35
GS f n.....	36
GS h n.....	36
①GS k m d1...dk NUL②GS k m n d1...dn.....	37
GS w n.....	39
ESC Z m n k dL dH d1 ...dn.....	40
GS Z n.....	41
① GS k m v r d1...dn NUL②GS k m v r nL nH d1...dn.....	41
FS ! n.....	42
FS &.....	43
FS - n.....	43
FS	44
FS 2 c1 c2 d1...dk.....	44
FS C n.....	45
FS S n1 n2.....	46
FS W n.....	46
Appendix A: 128 code.....	48
Appendix B: the pre-print black mark description.....	55

Chapter1 Outer Appearance and Dimension

1.1 Outer Appearance



FEED button (Indicator)

Installation ear

Open button

1.2 Outline Dimension

Installation size: 103.5mm×95.5mm (W×H) Depth:67.5mm
Out frame size: 110mm×101mm×70.5mm (W×H×D)

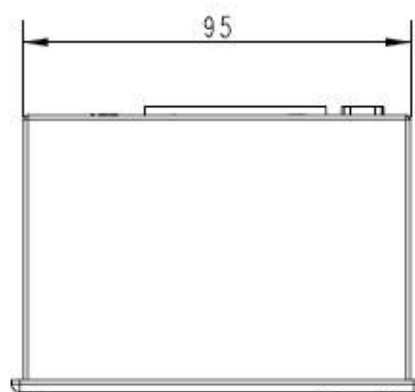
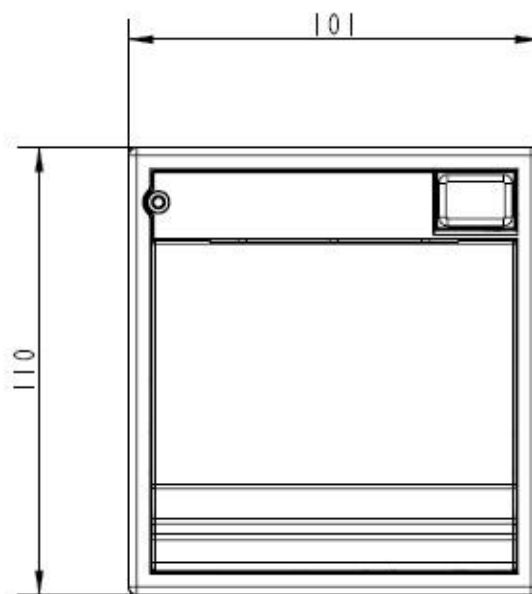
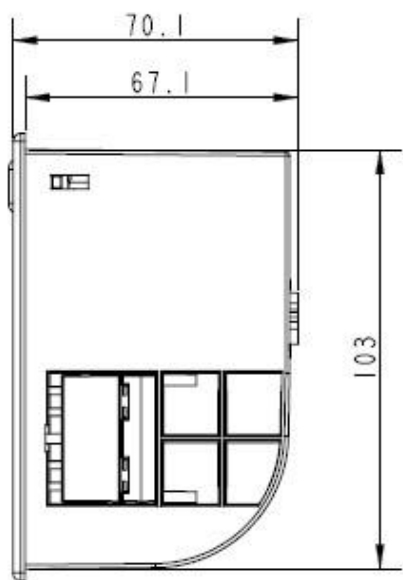

Chapter2 Interface Definition and Description

2.1 Serial Interface Appearance

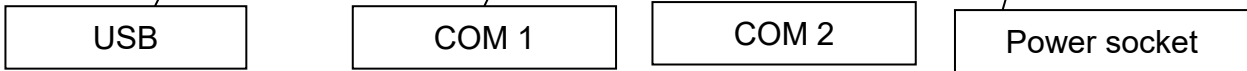
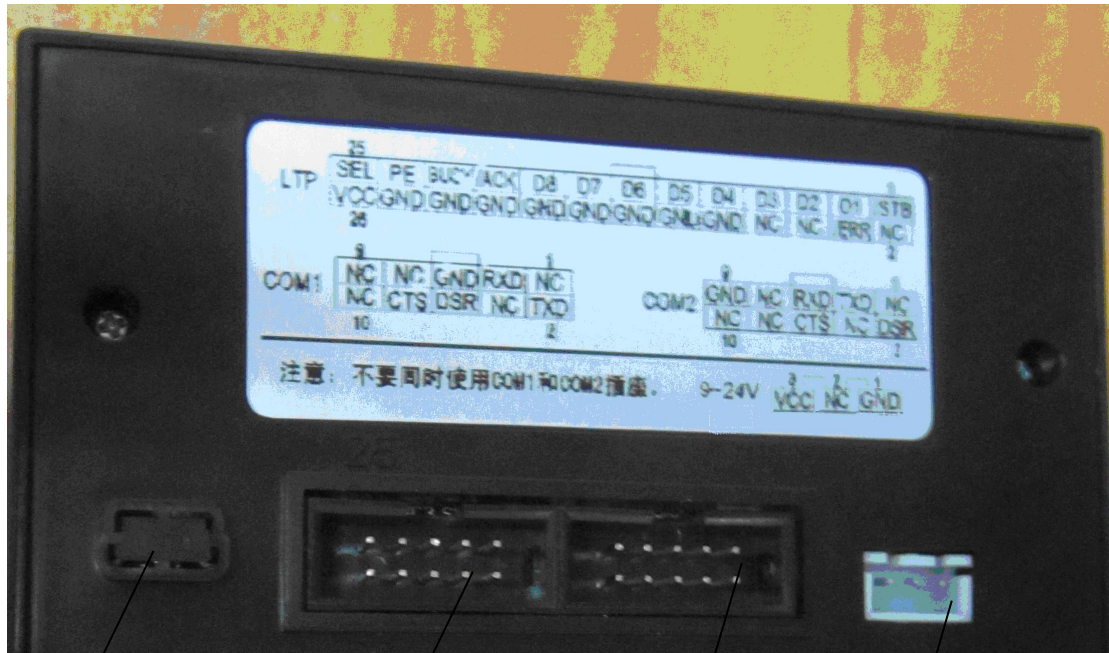

2.2 Pin Definition of Serial Interface

RME3 serial port have COM1 and COM2, both of them use IDC-10 socket, their function are the same, only the definition order of ports are different, specific pins definition for RS23 and TTL interface is as figure2-1 and figure 2-2.

Notice: Don't use two sockets at the same time

Signal	Pin No .	Source	Description
TXD	2	Printer	Printer transmits data to host
RXD	3	Host	Printer receives data from host
CTS	8	Printer	Hardware flow control signal between printer and host (busy signal)
DSR	6	Printer	As CTS
GND	5	—	

Figure 2- 1 serial COM1 of RME3 series interface socket pins definition

Signal	Pin No .	Source	Description
TXD	3	Printer	Printer transmits data to host
RXD	5	Host	Printer receives data from host
CTS	6	Printer	Printer and host hardware flow control signal busy signal
DSR	2	Printer	As CTS
GND	9	—	

Figure 2-2 serial COM2 of RME3 series interface socket pins definition

For 485 interface, specific definition of PIN is as below:

Signal	COM1	COM2
A	2	3
B	3	5

2.3 Parallel interface appearance



2.4 The pin definition of parallel port

Parallel interface is compatible with CENIRONICS RME3 printer interface, the interface of 26 line of flat cable plug and socket adapter, parallel interface socket pin definition as shown in table 2-3:

Signal	Pin No.	Signal source	Function
/STB	1	host	Gate trigger
D1	3	host	The lowest of parallel data
D2	5	host	The second of parallel data
D3	7	host	The third of parallel data
D4	9	host	The fourth of parallel data
D5	11	host	The fifth of parallel data
D6	13	host	The sixth of parallel data
D7	15	host	The seventh of parallel data
D8	17	host	The highest of parallel data
/ACK	19	printer	Answer pulse, "low" level represent data has been accepted and the printer is ready to receive data
BUSY	21	printer	"High level" said printer is "busy" can not accept the data
PE	23	printer	"High" said printer paper, "low" that paper
SEL	25	-	The resistance to the "high" level. Said the printer online
/ERR	4	-	The resistance to the "high" level, said trouble-free
NC	6, 8	-	unconnected
GND	10、 12、 14 16、 18、 20 22、 24	-	Grounding, logic "0" level
VCC	26	-	The default dangling, can also be customized to export 5 v

Table 2-3 Parallel interface PIN definition of SP-RME3

2.5 USB interface

Use standard Mini USB B

2.6 Power Port

3 is the positive input to external power, and 1 for external input power supply. Don't connect against!

Chapter3 Characteristic Specification

3.1 Printing capability

Printing method: Line thermal;

Paper width: 57.5 ± 0.5 mm

Printing width: 48mm;

Resolution: 8dots/mm(203dpi);

Dots per line: 384dots;

Printing speed :Max 100mm/S ($\leq 25\%$ printing dots)

TPH: 50KM

Paper thickness: 60~80 μ m;

Printable content: GB18030 all Chinese and characters, BIG5 Traditional Chinese characters, ASCII, self-defining character, One-dimensional bar code, Support different density map and downloading bitmap printing.

3.2 Power Supply

DC 9~24V $\pm 10\%$, 2A

3.3 Paper Specification

- (1) Paper type: thermal;
- (2) Paper thickness: 0.06~0.08 mm;
- (3) Paper roll diameter: max $\Phi 60$ mm;
- (4) Paper supply method: Drop-in easy loading;
- (5) Cutting method: Auto cutting (Full/Partial cut).

3.4 Environment request

Working environment and humidity: 0~50 $^{\circ}$ C , 10~80%

Storage environment and humidity: -20~60 $^{\circ}$ C , 10~90%

Chapter 4 Operating instruction

Notice when operating:

Please do not close paper cover with big strength. The right operating method is: first, put down the paper cover slowly neat to printer head; then, press paper cover to make it shut closely.



4.1 Button and indicator description

There are one button (Feed button) and one indicator, the indicator is red. The meanings of indicator are as below:



Light constant on: print unit is on



Light flashing: printer has mistakes. Different types of mistake, different ways of flashing

1. The mistake can be automatically recovered when the indicator continuous flashing. Including the temperature mistake of printer head and opening of paper case cover.

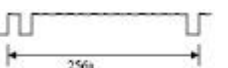
Error	Description	The flashing way of 【ERROR】 ERROR
Temperature of printer head	The temperature of printer head is too high, it will recover automatically when the temperature is normal	
Out of paper errors	After installed the paper, it will recover automatically when out of paper.	

2. The mistake can be automatically recovered when the indicator continuous flashing. Including the temperature mistake of printer head and opening of paper case cover.

Error	Description	The flashing way of [ERROR] ERROR
Memory	The printer can not work normally after the memory need to be read-write calibration	
Over voltage	The voltage of power is too high	

Owe voltage	The voltage of power is too low	
The CPU execution	The CPU execution to the wrong address	
Temperature detection circuit	Connection of temperature detection circuit connection error	

4.2 Self-Test

After receiving the printer, user can check its current setting and status at anytime. Self-test way is as below: Power off, then hold down the **【FEED】** button and press the power button at the same time. Then restart the printer.

Chapter 5 Printing Command

-->	b	n	Real time transmission status		
-->	[Format]	ASCII	DLE	EOT	n
		Hex	10	04	n
		Decimal	16	4	n
-->	[Range]	1 ≤ n ≤ 4			
-->	[Description]	Sending the printer state that designated by parameter n just in time			
-->	[Note]	· When printer receives the command, returns to the interrelated status immediately			
-->	[Reference]				

HT

[Name]	Horizontal tab	
[Format]	ASCII	HT
	Hex	09
	Decimal	9
[Description]	Moves the print position to the next horizontal tab position.	
[Note]	<ul style="list-style-type: none"> • This command is ignored unless the next horizontal tab position has been set. • If the next position of horizontal tab exceeds the printing area, the current position will be set as [printing width+1]. • Horizontal tab positions are set with ESCD. • If the current position is at [printing width+1] when receives the command, the printer will carry out the action in row buffer and move the printing position to the Zero position of next line. • The default value of tab position is every 8 standard ASCII characters (12*24) a tab. • When the current row buffer is full, the printer will carry out the action below: 	

Under standard mode, printer prints the content of current row and sets the Printing position at the zero position of next line

Under page mode, the printer begins a new line and set the printing position at the zero position of next line.

[Reference] **ESC D**

LF

[Name]	Printing and feeding line	
[Format]	ASCII	LF
	Hex	0A

Decimal 10

[Description] Printing the data in the print buffer and feeds one line

[Note] This command sets the print position to the beginning of the line.

[Reference] **ESC 2, ESC 3**

FF

[Name] Printing and feeding paper

[Format] ASCII FF

Hex 0C

Decimal 12

[Description] Printing all of the content in print buffer and returning to the standard mode, under the standard mode, if the printer establishes in the black mark paper mode, then printing the data in the buffer to feed paper to the black mark section, if haven't black mark, then feed the paper 30cm behind stop, the pre-print black mark specification is showed in the appendix C. the pre-print black mark instruction. If not at the black mark examing status and then only print the contents of buffer, don't feed paper.

[Note] Clearing the content in print buffer after printing.

- The printing area setup by ESC W returns to the default
- The printer won't cut paper.
- This command sets the current position at the beginning of the line

[Reference] **ESC FF, ESC L, ESC S**

CR

[Name] Printing and entering

[Format] ASCII CR

Hex 0D

Decimal 13

[Description] The same as LF when the command is permitted, if not , it will be ignored.

[Note]

- Setting the printing position at the beginning of the line.
- The command is ignored under the serial interface mode.
- The printer allocation decides If the command is enabled under parallel mode.

[Reference] **LF**

DLE EOT n

[Name] Real time status transmission

[Format] ASCII DLE EOT n

Hex 10 04 n

Decimal 16 4 n

[Range] $1 \leq n \leq 4$

[Description]

Sending the printer state that designated by parameter n just in time:

n=1:Sending state of the printer

n=2:Sending off line state

n=3:Sending error state

n=4:Sending state of paper sensor

[Note]

-When printer receives the command, returns to the interrelated status immediately

Avoiding to put this command in the command sequence of more than 2 characters.

This command will be also valid even though the printer is set to forbid by the

Command of ESC=(selecting peripheral).

When sending printer current state, each state is indicated by 1 byte

Transmission state value of the printer can not confirm whether the master computer received

Printer will carry out the command immediately once received

This command is just available to the serial printer. The printer will carry out the command immediately under any state

n = 1: Printer state

Bit	0/1	HEX	Decimal	Function
0	0	00	0	Fix as 0
1	1	02	2	Fix as 1
2	0	00	0	The cash box open/close signal is low(the third of cash box plug leads foot)
	1	04	4	The cash box open/close signal is high(the third of cash box plug leads foot)
3	0	00	0	online
	1	08	8	offline
4	1	10	16	Fix as 1
5,6				undefined
7	0	00	00	Fix as 0

n = 2: Off line state

Bit	0/1	HEX	Decimal	Function
0	0	00	0	fix as 0
1	1	02	2	fix as 1
2	0	00	0	close the top cover
	1	04	4	open the top cover
3	0	00	0	Not holding down the feed button
	1	08	8	holding down the feed button
4	1	10	16	fix as 1
5	0	00	0	Printer is not out of paper
	1	20	32	Printer is out of paper
6	0	00	0	No error state
	1	40	64	error state

7	0	00	0	fix as 0
---	---	----	---	----------

n = 3: error state

Bit	0/1	HEX	Decimal	Function
0	0	00	0	Fix as 0
1	1	02	2	Fix as 1
2	-	-	-	undefined
3	0	00	0	noun cutter error
	1	08	8	cutter error
4	1	10	16	Fix as 1
5	0	00	0	noun unrecoverable error
	1	20	32	have unrecoverable error
6	0	00	0	noun auto recoverable error
	1	40	64	have auto recoverable error
7	0	00	0	Fix as 0

n = 4: paper sensor state

Bit	1/0	HEX	Decimal	Function
0	0	00	0	Fix as 0
1	1	02	2	Fix as 1
2,3	0	00	0	The sensor of paper is going out: have enough paper
	1	0C	12	The sensor of paper is going out:the paper is going out
4	1	10	16	Fix as 1
5,6	0	00	0	lack of paper sensor: have paper
	1	60	96	lack of paper sensor: noun paper
7	0	00	0	Fix as 0

[Reference] **DLE ENQ, GS a, GS r**

ESC SP n

[Name] Setting the right space of characters

[Format] ASCII ESC SP n
Hex 1B 20 n
Decimal 27 32 n

[Range] $0 \leq n \leq 255$

[Description] Setting the right space of character for [n*units of vertical or lateral shifting]

[Note]

-When the character enlarges, the space enlarges the same times.

-The command doesn't affect the setup of Chinese characters.

-The value which is set by the command under page and standard mode is mutual independence.

-Units of vertical or lateral shifting area pointed by GSP. Changing units of vertical or lateral shifting does not change the current right space.

- Using lateral shifting units under standard mode.
- According to the direction of printing area and the beginning position to select vertical or lateral shifting units under page mode.

The selection modes areas below:

- ①Using lateral shifting when the beginning position is the top left or lower right corner of the printing area which is set by ESC T;
- ②Using vertical shifting when the beginning position is the lower left or top right corner of the printing area which is set by ESC T;

The maximum right space is 255/203 inches. If setting beyond this value, it will automatically change into the maximum distance.

[Default] n = 0

[Reference] **GS P**

ESC ! n

[Name] selecting print mode

[Format]	ASCII	ESC	!	n
	Hex	1B	21	n
	Decimal	27	33	n

[Range] $0 \leq n \leq 255$

[Description]

Setting character print mode according to value of n

Bit	1/0	HEX	Decima l	Function
0	0	00	0	Standard ASCII style A (12×24)
	1	01	1	Compressing ASCII style B(9×17)
1,2				Undefined
3	0	00	0	Cancel bold font
	1	08	8	Select bold font
4	0	00	0	Cancel double height mode
	1	10	16	Select double height mode
5	0	00	0	Cancel double width mode
	1	20	32	Select double width mode
6				Undefined
7	0	00	0	Cancel underline mode
	1	80	128	Select underline mode

[Note]

- When selected double-height or double-width mode, double size characters are printed.
- Any character can be added underline except the space set by HT and the characters clockwise 90 degrees.
- Underline is not related to characters but confirmed by ESC-.

-When some characters in a line are double or more height, all the characters on the line are aligned at the baseline.

-ESC E can also select or cancel bold font. However, the command of the setting of the last received command is effective.

-ESC- can also turn on or off underline mode. However, the setting of the last received command is effective.

-GS ! can also set the character boundary. However, the setting of the last received command is effective.

· Bold font is effective for character and Chinese, except bold font, other modes is only effective for character.

[Default] n = 0

[Reference] **ESC -, ESC E, GS !**

ESC \$ nL nH

[Name] Setting absolute print position

[Format]	ASCII	ESC	\$	nL	nH
	Hex	1B	24	nL	nH
	Decimal	27	36	nL	nH

[Range] $0 \leq nL \leq 255$

$0 \leq nH \leq 255$

[Description] Setting the distance from the beginning of the line to the position at which $(nL + nH \times 256) \times (\text{vertical or horizontal motion unit})$

[Reference]

This command is ignored if the setting position is out of the printing area.

Vertical and horizontal motion units are set by GSP.

Using horizontal motion units under standard mode.

Under page mode, selecting to use vertical or horizontal motion units according to the direction of printing area and zero position. The system of selection is as below:

① Using horizontal shifting when the beginning position is the top left or lower

right corner of the printing area which is set by ESC T;

② Using vertical shifting when the beginning position is the lower left or top right corner of the printing area which is set by ESC T;

[Reference] **ESC \, GS \$, GS \, GS P**

ESC % n

[Name] Selecting/Canceling self defined character

[Format]	ASCII	ESC	%	n
	Hex	1B	25	n
	Decimal	27	37	n

[Range] $0 \leq n \leq 255$

[Description] Selecting/Canceling self-defined character

· When $n(\text{LSB})=0$, cancel user-defined character set.

- When n(LSB)=1,select user-defined character set.
- [Note] · When cancel user-defined character set, auto select built-in character set.
- n only LSB is available.
- [Default] n = 0
- [Reference] **ESC &, ESC ?**

ESC & y c1 c2 [x1 d1...d(y × x1)]...[xk d1...d(y × xk)]

[Name] Define user defined character

[Format] ASCII ESC & y c1 c2 [x1 d1...d(y × x1)]...[xk d1...d(y × xk)]

Hex 1B 26 y c1 c2 [x1 d1...d(y × x1)]...[xk d1...d(y × xk)]

Decimal 27 38 y c1 c2 [x1 d1...d(y × x1)]...[xk d1...d(y × xk)]

[Range] y = 3

32 ≤ c1 ≤ c2 ≤ 126

0 ≤ x ≤ 12 standard ASCII style A(12×24)

0 ≤ x ≤ 9 compressing ASCII style B (9 × 17)

0 ≤ d1 ... d(y × xk) ≤ 255

- [Description] Define user defined character
- y specify the vertical byte number
 - c1 specify the code of initial character,c2 specify the code of terminal character.
 - x specify the vertical byte number
- [Note]
- The code range of defined character: from<20>Hto<7E>H.(95 characters)
 - Can define the continuous codes for several characters. When only one character is needed,c1=c2.
 - d is the dot data of the character. Data of each dot begins from the left.
 - Defining the data of user defined character is (y×x)bytes.
 - Setting the printing dot's corresponding bit is 1 or nonprinting dot's one is 0.
 - The user defined characters will be deleted in the following situation:
 - ① ESC @ is carried out
 - ② ESC ? is carried out
 - ③ The printer reset or power off.
 - Only the MSB is valid at the vertical third byte when the self-defined characters are style B(9*17)
- [Default] Built in character set.
- [Reference] **ESC %, ESC ?**
- [Example] ·When select the standard ASCII style(12×24)

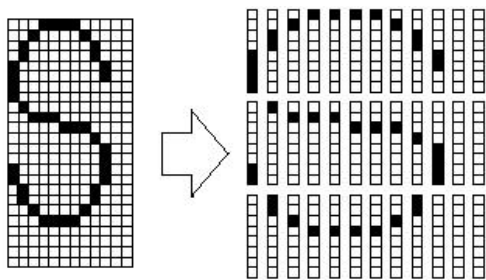
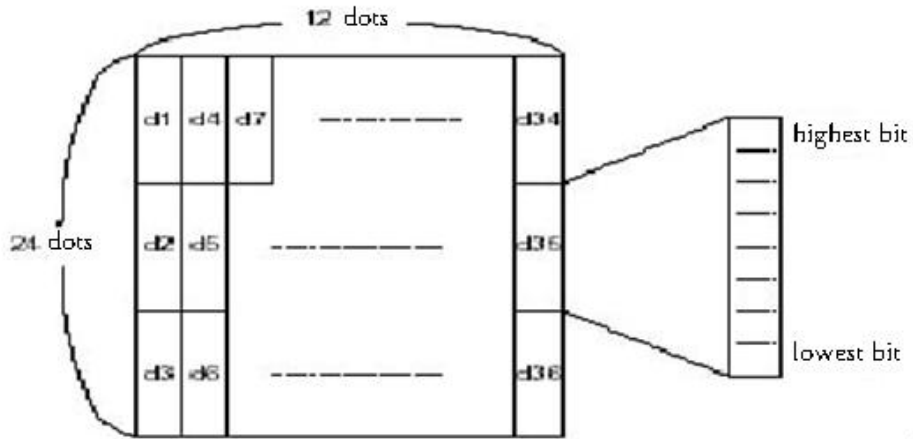

d1 = <0F>H d4 = <30>H d7 = <40>H
 d2 = <03>H d5 = <80>H d8 = <40>H
 d3 = <00>H d6 = <00>H d9 = <20>H

·When select the compressing ASCII style (9×17)

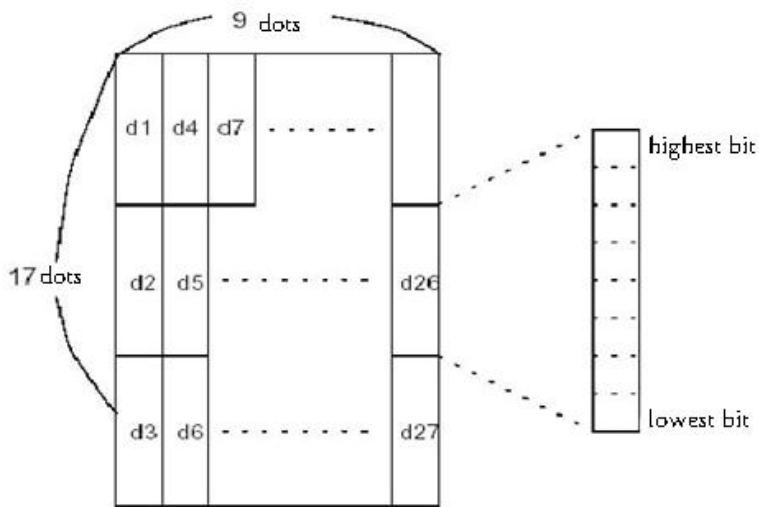

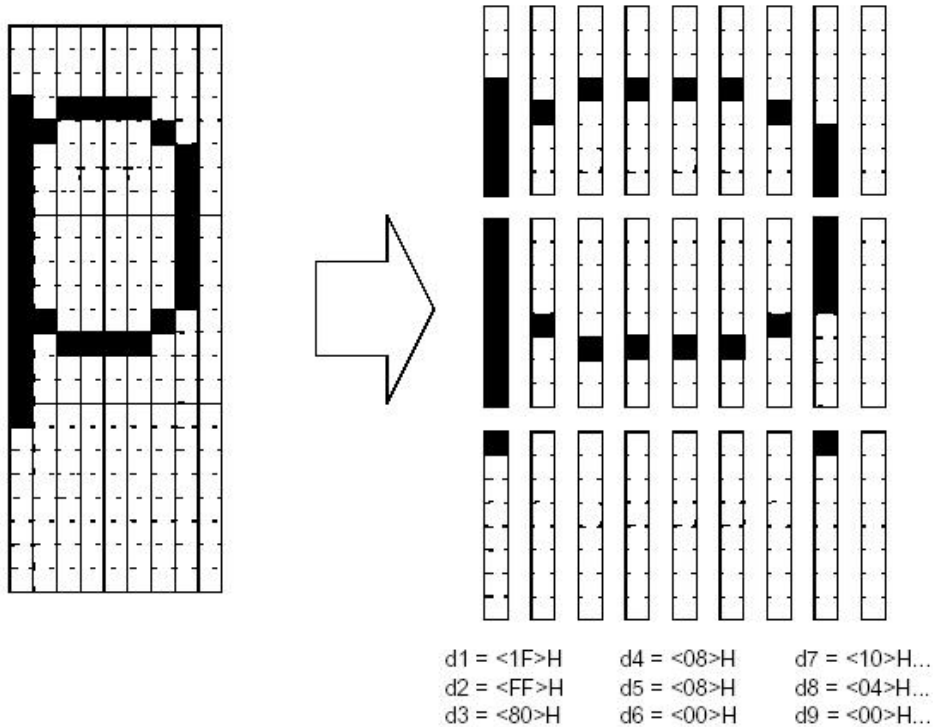

ESC * m nL nH d1... dk

[Name] Selecting bit map mode

[Format] ASCII ESC * m nL nH d1...dk
Hex 1B 2A m nL nH d1...dk
Decimal 27 42 m nL nH d1...dk

[Range] m = 0, 1, 32, 33
0 ≤ nL ≤ 255
0 ≤ nH ≤ 3
0 ≤ d ≤ 255

[Description] Selects a bit map mode appointed by m for the number of dots specified by nL and nH, as follows:

m	Mode	Vertical		Horizontal	
		dots	Dpi	Dpi	No.of datas (k)
0	8SD	8	68 DPI	101 DPI	nL + nH × 256
1	8DD	8	68 DPI	203 DPI	nL + nH × 256
32	24SD	24	203 DPI	101 DPI	(nL + nH × 256) × 3
33	24DD	24	203 DP	203 DPI	(nL + nH × 256) × 3

[Note] · If the value of m goes beyond the range, nL and the datas later will be regarded as normal data to deal with.
· The dots number of horizontal printing depends on nL and nH, total number is nL+nH×256.

- The part of the bit map that goes beyond the current area will be cut off
- d is the data of bit map. Printing when the relevant position of every byte is 1, and when it is 0, will not print this point.
- mode of normal data processing after send the data of bit map.
- Except inversion mode, this command will not be influenced by other modes. (black、double print、underline、enlarge character and invert)
- Relationship between data and printing point is as below:
- choosing 8 dots density:

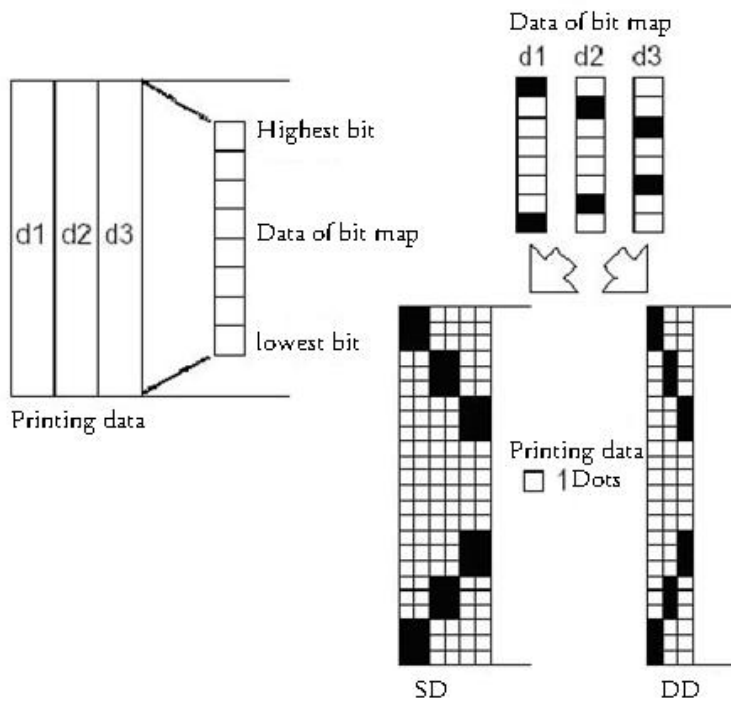

- choosing 24 dots density:

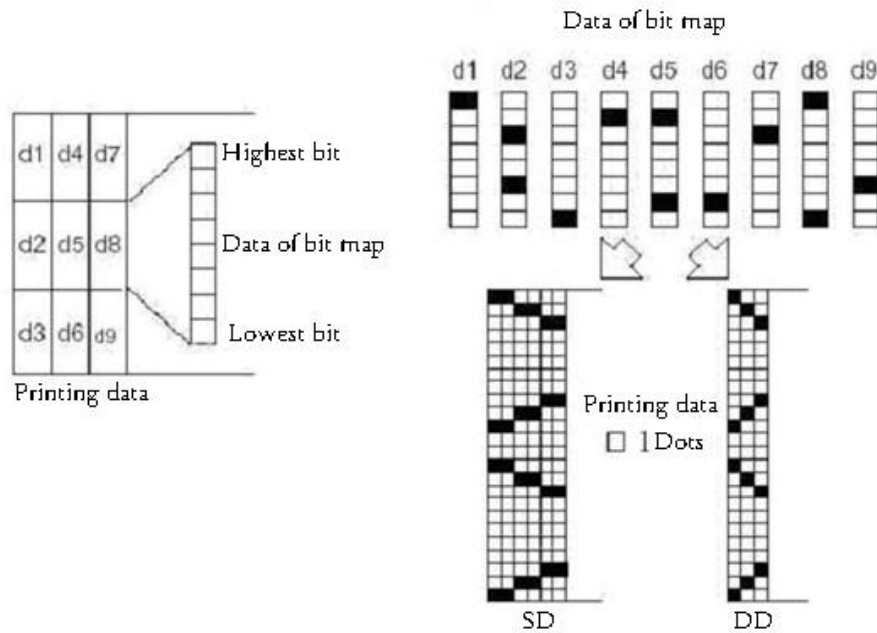

ESC - n

[Name] Select / cancel underline

[Format] ASCII ESC - n
 Hex 1B 2D n
 Decimal 27 45 n

[Range] $0 \leq n \leq 2, 48 \leq n \leq 50$

[Description] Selecting or canceling the underline mode according to the value of n

n	Function
0, 48	Cancel underline mode
1, 49	Select underline mode(1dot width)
2, 50	Select underline mode(2 dots width)

[Note]

- Underline can be added under all characters(including right spacing),but not including the space set by HT
- The underline can not act on the characters of clockwise 90 degrees and inverting
- The width of the underline will not be changed, and the character rest will not be underlined when cancel the underline mode. The default width is 1dot width.
- Changing the character boundary will not influence the current underline width
- Selecting/canceling the underline can also be set by ESC!. However, the setting of the last received command is effective.
- The command doesn't affect the Chinese character setting.

[Default] n = 0

[Reference] **ESC !**

ESC 2

[Name] Setting default height of line

[Format] ASCII ESC 2
 Hex 1B 32
 Decimal 27 50

[Description] Selecting 32 dots (4mm, about 1/7 inch) line height

[Note] · Line height is independent under standard and page mode

[Reference] **ESC 3**

ESC 3 n

[Name] Setting the height of the line

[Format] ASCII ESC 3 n
 Hex 1B 33 n
 Decimal 27 51 n

[Range] $0 \leq n \leq 255$

[Note] Setting [n*units of vertical or lateral shifting] inches as the height of the line

[Note] · Setting [n*units of vertical or lateral shifting] inches as the height of the line
· Units of vertical or lateral shifting are set by GSP, changing this setting will not influence current height of line
· Using vertical shifting units under standard mode
· According to the direction of printing area and the beginning position to select lateral or vertical shifting units under page mode. The selection modes are as below:
① Using vertical shifting when the beginning position is the top left or lower right corner of the printing area which is set by ESC T;
② Using lateral shifting when the beginning position is the lower left or top right corner of the printing area which is set by ESC T;
· The maximum distance of feeding paper is 1016mm(40 inches). If it is beyond this distance, taking the maximum distance.

[Default value] The default height of line is 4mm (about 1/6 inch)

[Reference] **ESC 2, GS P**

ESC = n

[Name] Selecting printer

[Format] ASCII ESC = n
 Hex 1B 3D n
 Decimal 27 61 n

[Range] $0 \leq n \leq 1$

[Description] Selecting printer, the printer selected can receive the data sent by main

computer:

Bit	1/0	Hex	Decimal	Function
0	0	00	0	Forbidding printer
	1	01	1	Permitting printer
1-7				Undefined

[Note] · When the printer is forbidden, the printer ignores all the commands(DLE EOT, DLE ENQ, DLE DC4)except real time command until the command is allowed.

[Default value] n = 1

ESC ? n

[Name] cancel user self-defined character

[Format] ASCII ESC ? n
Hex 1B 3F n
Decimal 27 63 n

[Range] 32 ≤ n ≤ 127

[Description] Cancel user self-defined character

[Note]

- Cancel the character code n of user self-defined character. The character use in character after canceling .
- The command deletes from the matrix which is selected by the mould concentrates to the specified code of the selective ESC !
- The command is ignored if the self-defined characters have no the character.

[Reference] **ESC &, ESC %**

ESC @

[Name] Initializing the printer

[Format] ASCII ESC @
Hex 1B 40
Decimal 27 64

[Description] Clearing the data in the printing buffer; The printing mode is set to the default

[Note]

- The DIP switch set does not test again.
- Retaining the content in command buffer
- Retaining the macro definition
- Flash bit map is not erased
- Flash user data is not erased
- Servicing counter value is not erased
- The set value specified by GS(E is not erased.

ESC D n1...nk NUL

[Name]	Setting horizontal tab positions				
[Format]	ASCII	ESC	D	n1...nk	NUL
	Hex	1B	44	n1...nk	00
	Decimal	27	68	n1...nk	0
[Range]	$1 \leq n1 \leq n2 \leq \dots \leq nk \leq 255$ $0 \leq k \leq 32$				
[Description]	Setting horizontal tab positions ·N specifies the column number for setting a horizontal tab position from the beginning of the line. ·There are k tab positions.				
[Note]	·Horizontal tab positions can be gotten by the following formula: The horizontal tab position is stored as a value of [character width ×n]measured from the beginning of the line. The character width includes the right side character spacing, and double width characters are set with twice the width of normal characters. · This command cancels the previous horizontal tab settings. · When setting n=8,the print position is moved to column 9 · Up to 32 tab positions(k=32)can be set. Data exceeding32tab positions is processed as normal data ·Tab position is ordered by ascending and the end mark is NUL ·When[n]k is less than or equal to the preceding value[n]k-1,tab setting is finished and the following data is processed as normal data. ·ESC D NUL cancels all horizontal tab positions. · The previously specified horizontal tab positions do not change,even if the character width changes ·The character width is independence under standard and page mode				
[Default]	The default tab positions are at intervals of 8 characters for font A(12'24).				
[Reference]	HT				

ESC E n

[Name]	Select / Cancel bold font print			
[Format]	ASCII	ESC	E	n
	Hex	1B	45	n
	Decimal	27	69	n
[Range]	$0 \leq n \leq 255$			
[Description]	Select / Cancel bold font print When the lowest bit of n is 0, cancel bold font print When the lowest bit of n is 1, select bold font print			
[Note]	·Only the lowest bit of n is effective. ·Selecting/canceling bold font print can also be set by ESC!. However, the setting of the last received command is effective.			

[Default value] n = 0

[Reference] **ESC !**

ESC G n

[Name] Selecting/canceling double print mode

[Format] ASCII ESC G n
 Hex 1B 47 n
 Decimal 27 71 n

[Range] $0 \leq n \leq 255$

[Description] Selecting/canceling double print mode

- When the lowest bit of n is 0,canceling double print mode
- When the lowest bit of n is 1,selecting double print mode

[Note] ·Only the lowest bit of n is effective.

- The effect of this command is the same as bold font printing.

[Default value] n = 0

[Reference] **ESC E**

ESC J n

[Name] Printing and feeding paper

[Format] ASCII ESC J n
 Hex 1B 4A n
 Decimal 27 74 n

[Range] $0 \leq n \leq 255$

[Description] Printing datas in print buffer and feeding paper for [n*units of vertical or lateral shifting] inches

- [注释]
- The current print position will be set to the beginning of the line after printing.
 - The ESC 2 and ESC 3 commands set does affect the feeding distance.
 - Units of vertical or lateral shifting are set by GSP
 - Using vertical shifting units under standard mode
 - According to the direction of printing area and the beginning position to select vertical or lateral shifting units under page mode.The selection modes are as below:
 - ① Using vertical shifting when the beginning position is the top left or lower right corner of the printing area which is set by ESC T;
 - ② Using lateral shifting when the beginning position is the lower left or top right corner of the printing area which is set by ESC T;
 - The maximum distance of feeding paper is 1016mm(40inches).If it is beyond this distance, taking the maximum distance.

[Reference] **GS P**

ESC M n

[Name] select font

[Format] ASCII ESC M n

Hex 1B 4D n
 Decimal 27 77 n
 [Range] n = 0, 1,48, 49
 [Description] select font

n	function
0,48	select standard ASCII style(12*24)
1,49	select compressing ASCII style (9*17)

[Default value] n = 0

ESC R n

[Name] Selecting international character set
 [Format] ASCII ESC R n
 Hex 1B 52 n
 Decimal 27 82 n
 [Range] 0 ≤ n ≤ 15
 [Description] Selecting a n international character set from the table below

n	Character Set
0	U.S.A.
1	France
2	Germany
3	U.K.
4	Denmark I
5	Sweden
6	Italy
7	Spain I
8	Japan
9	Norway
10	Denmark II
11	Spain II
12	Latin
13	Korea
14	Slovenia/Croatia
15	China

[Default] n = 15 [GBK]
 n = 0 [the model except GBK]

[Reference]

ESC \ nL nH

[Name] Setting relative printing position
 [Format] ASCII ESC \ nL nH
 Hex 1B 5C nL nH

	Decimal	27	92	nL	nH
[Range]	0 ≤ nL ≤ 255		0 ≤ nH ≤ 255		
[Description]	Sets the lateral relative position based on the current position by using the Horizontal or vertical motion unit				
	· This command sets the distance from the current position to n[(nL+nH×256)horizontal motion unit]				
[Note]	· Any setting that exceeds the printable area is ignored.				
	· When printing position moves to the right:nL+nH×256=N.				
	· When printing position moves to the left,using radix complement:nL+nH×256=65536-N.				
	· The print starting position moves from the current position to[N×horizontal motion unit]				
	· Vertical and horizontal motion units are set by GSP command.				
	· Horizontal motion units are used under standard mode.				
	· Under page mode, selecting to use horizontal or vertical motion units according to the direction of printing area and zero position.				
	The system of selection is as below:				
	① Using horizontal shifting when the beginning position is the top left or lower right corner of the printing area which is set by ESC T;				
	② Using vertical shifting when the beginning position is the lower left or top right corner of the printing area which is set by ESC T				
[Reference]	ESC \$, GS P				

ESC a n

[Name]	Selecting alignment mode			
[Format]	ASCII	ESC	a	n
	Hex	1B	61	n
	Decimal	27	97	n
[Range]	0 ≤ n ≤ 2, 48 ≤ n ≤ 50			
[Description]	Making all the printing datas array in appointed alignment			
	Relationship between value of n and alignment are as below:			
	n	Alignment		
	0,48	Align left		
	1, 49	Align center		
	2, 50	Align right		
[Note]	· This command is just available at the zero position of the line and under Standard mode.			
	· This command just changes the internal mark position under page mode.			
	· This command revises the blank area according to HT,ESC\$ or ESC\.			

[Default value] n = 0

[Example]

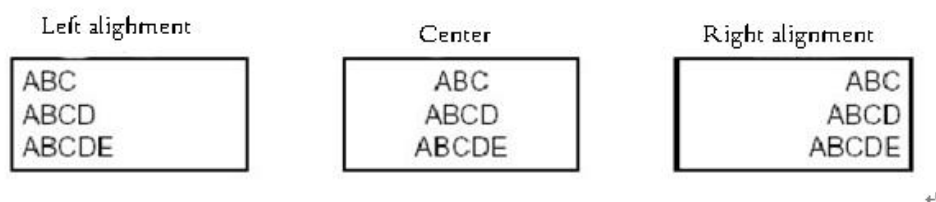

ESC c 5 n

[Name] Permitting/Forbiding key stroke

[Format]	ASCII	ESC	c	5	n
	Hex	1B	63	35	n
	Decimal	27	99	53	n

[Range] $0 \leq n \leq 255$

[Description] Permitting/Forbiding key stroke.

- When the lowest bit of n is 0, key stroke works
- When the lowest bit of n is 1, key stroke is forbidden.

[Note] · Only the lowest bit of n is effective.

- When the key stroke is forbidden, it does not work
- When carrying out the macro command, key stroke works all the time, but can not feed paper by it

[Default value] n = 0

ESC d n

[Name] Printing and feeding paper forward for n lines

[Format]	ASCII	ESC	d	n
	Hex	1B	64	n
	Decimal	27	100	n

[Range] $0 \leq n \leq 255$

[Description] Printing the data in print buffer and feeding paper forward for n lines (character row)

[Note] · This command sets the loading position at the beginning of the row

- This command does not influence the line space which is set by ESC 2 or ESC 3
- The maximum distance of feeding paper is 1016mm. If it is beyond this distance, taking the maximum distance.

[Reference] **ESC 2, ESC 3**

ESC t n

[Name] Selecting character code table

[Format] ASCII ESC t n
 Hex 1B 74 n
 Decimal 27 116 n

[Range] 0 ≤ n ≤ 255

[Description] Selecting code page n from character code table. Selection of n are as below:

N	代码页	Code Page
0	CP437 [美国,欧洲标准]	CP437 [U.S.A., Standard Europe]
1	KataKana [片假名]	Katakana
2	PC850 [多语言]	PC850 [Multilingual]
3	PC860 [葡萄牙]	PC860 [Portuguese]
4	PC863 [加拿大-法语]	PC863 [Canadian-French]
5	PC865 [北欧]	PC865 [Nordic]
6	WCP1251 [斯拉夫语]	WCP1251 [Cyrillic]
7	CP866 斯拉夫2	CP866 Cyrillic #2
8	MIK[斯拉夫/保加利亚]	MIK[Cyrillic /Bulgarian]
9	CP755 [东欧,拉脱维亚 2]	CP755 [East Europe,Latvian 2]
10	[伊朗,波斯]	Iran
11	保留	reserve
12	保留	reserve
13	保留	reserve
14	保留	reserve
15	CP862 [希伯来]	CP862 [Hebrew]
16	WCP1252 [拉丁语 1]	WCP1252 Latin I
17	WCP1253 [希腊]	WCP1253 [Greek]
18	CP852 [拉丁语 2]	CP852 [Latina 2]
19	CP858 [多种语言拉丁语 1+ 欧元符]	CP858 Multilingual Latin I +Euro)
20	伊朗 II [波斯语]	Iran II
21	拉脱维亚	Latvian
22	CP864 [阿拉伯语]	CP864 [Arabic]
23	ISO-8859-1 [西欧]	ISO-8859-1 [West Europe]
24	CP737 [希腊]	CP737 [Greek]
25	WCP1257 [波罗的海]	WCP1257 [Baltic]
26	[泰文1]	Thai 1
27	CP720[阿拉伯语]	CP720[Arabic]
28	CP855	CP855
29	CP857[土耳其语]	CP857[Turkish]
30	WCP1250[中欧]	WCP1250[Central Europe]
31	CP775	CP775
32	WCP1254[土耳其语]	WCP1254[Turkish]
33	WCP1255[希伯来语]	WCP1255[Hebrew]
34	WCP1256[阿拉伯语]	WCP1256[Arabic]

35	WCP1258[越南语]	WCP1258[Vietnam]
36	ISO-8859-2[拉丁语2]	ISO-8859-2[Latin 2]
37	ISO-8859-3[拉丁语3]	ISO-8859-3[Latin 3]
38	ISO-8859-4[波罗的语]	ISO-8859-4[Baltic]
39	ISO-8859-5[斯拉夫语]	ISO-8859-5[Cyrillic]
40	ISO-8859-6[阿拉伯语]	ISO-8859-6[Arabic]
41	ISO-8859-7[希腊语]	ISO-8859-7[Greek]
42	ISO-8859-8[希伯来语]	ISO-8859-8[Hebrew]
43	ISO-8859-9[土耳其语]	ISO-8859-9[Turkish]
44	ISO-8859-15[拉丁语9]	ISO-8859-15 [Latin 3]
45	[泰文2]	Thai2
46	CP856	CP856

[Default value] n = 0

[Reference]

ESC { n

[Name] Selecting/canceling invert printing mode

[Format]	ASCII	ESC	{	n
	Hex	1B	7B	n
	Decimal	27	123	n

[Range] $0 \leq n \leq 255$

[Description] Selecting/canceling invert printing mode

- When the lowest bit of n is 0,canceling invert printing mode
- When the lowest bit of n is 1,selecting invert printing mode.

[Note] ·Only the lowest bit of n is effective.

- The command is just effective on the beginning of the line under standard mode.
- The command just changes internal marker bit under page mode.
- The command has no effect on the printing of page mode.
- Under invert printing mode, the printer will whirl the line of being printed for 180 degree.

[Default value] n = 0

[Example]

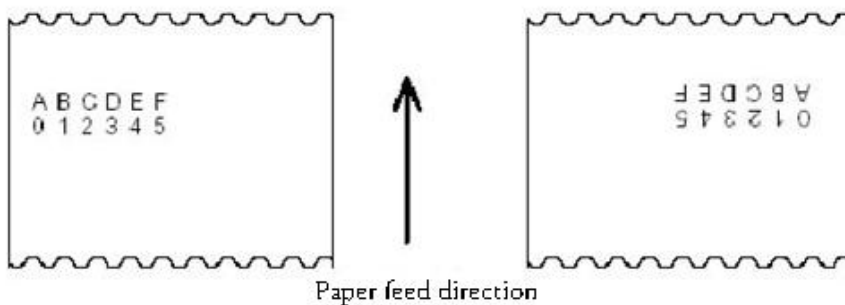

FS P n

[Name]	Printing the prestored bit map			
[Format]	ASCII	FS	P	n
	Hex	1C	50	n
	Decimal	28	80	n
[Range]	$0 \leq n \leq 7$			
[Description]	This command prints the 2 value bit map which is prestored in the printer and not easily lost. The bit map in memory which is not easily lost can be produced and written by the tool in PC. The max width is 576dots,and max height is 910 dots. N is the destination bit map code.			
[Note]	Before the destination bit map code has not been defined,this command is not available. . The bit map must be the 2 value bit map . This command will not be influenced by printing mode.(bold、overlap、underline、character dimension or inverse print). . If the width of being printed beyond one line, the out profile will not be printed . .It needs special purpose tools to print the downloaded bit map, Please see (T9 set tool software).The bit map by this mode does not lose unless download other bitmap to cover it .			

GS ! n

[Name]	Selecting character boundary			
[Format]	ASCII	GS	!	n
	Hex	1D	21	n
	Decimal	29	33	n
[Range]	$0 \leq n \leq 255$ ($1 \leq \text{longitudinal magnification multiple} \leq 8, 1 \leq \text{lateral magnification multiple} \leq 8$)			
[Description]	Using 0 to 2 bits to select character height,4 to7 bits to select character width			

As follows:

Bit	0/1	Hex	Decimal	Function
0-3				Selecting character width, see table1
4-7				Selecting character height, see table2

Table 1

Selecting character height

Hex	Decimal	longitudinal magnification
00	0	1 (normal)

Table 2

Selecting character width

Hex	Decimal	lateral magnification;
00	0	1 (normal)

01	1	2 (double width)	10	16	2 (double height)
02	2	3	20	32	3
03	3	4	30	48	4
04	4	5	40	64	5
05	5	6	50	80	6
06	6	7	60	96	7
07	7	8	70	112	8

[Note] · This command is effective to all the characters(ASCII and Chinese characters) except HRI characters.

· If n is out of the range, this command will be neglected.

· Under standard mode, portrait is the direction of feeding paper, landscape is perpendicular to the direction of feeding paper. But when the character rotates 90 degree clockwise, portrait and landscape are reversed.

· Portrait and landscape under page mode depend on the direction of the area.

· All the character are aligned baseline when the character of the same line enlarge different times

· Selecting/canceling the double width and double height of the character can also be set by ESC ! command. However, the setting of the last received command is effective.

[Default value] n = 0

[Reference] **ESC !**

GS * x y d1...d(x × y × 8)

[Name] Defining downloaded bit map

[Format] ASCII GS * x y d1...dk
Hex 1D 2A x y d1...dk
Decimal 29 42 x y d1...dk

[Range] $1 \leq x \leq 255, 1 \leq y \leq 48$
 $x \times y \leq 1536$
 $0 \leq d \leq 255$
 $k = x \times y \times 8$

[Description] Use appointed bit number by x and y to define the downloaded bit map

- x is the dot number of horizontal
- y is the dot number of vertical
- d is data of specified bit map

[Note] · $x \times 8$ is the dot number of horizontal.; $y \times 8$ is the dot number of vertical.
· If $x \times y$ is off limit, then the command is forbidden.

- d means the image data. 1 print, 0 not print
- In the following circumstances, clear the definition of downloaded bit image.:
 - ① carry out ESC@ command
 - ② Power off or reset

Relationship between print data and download bit map is as below:

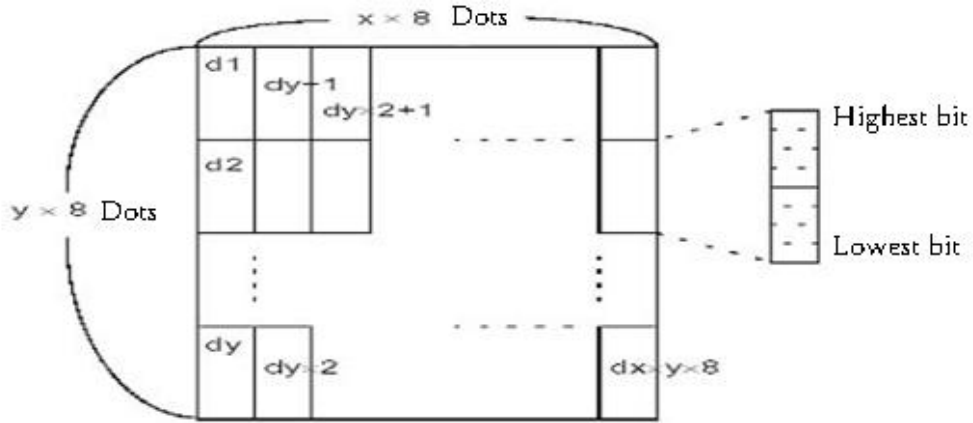

[Reference] **GS /**

GS / m

[Name]	Printing downloaded bit map			
[Format]	ASCII	GS	/	m
	Hex	1D	2F	m
	Decimal	29	47	m

[Range] $0 \leq m \leq 3, 48 \leq m \leq 51$

[Description] Printing mode is appointed by m when print a bit map

m printing mode selections are as below:

m	mode	vertical (DPI)	horizontal (DPI)
0, 48	normal	203	203
1, 49	Double width	203	101
2, 50	Double height	101	203
3, 51	Double width and height	101	101

[Note]

- This command will be ignored if the downloaded bit map is not defined.
- The command is effective only when there is no data in the printing buffer under standard mode
- Except inversion mode, other modes have no effect on it(include bold、 double print、 underline、 enlarge font and invert printing, etc.
- The out profile will not be printed if the bit map out of the range.
- This command prints the bit map downloaded in RAM but not Flash.

[Reference] **GS ***

ESC ' **Print Curve I**

Format: ASCII: ESC ' mL mH n1L n1H n2L n2H.....n1L n1H CR
 Decimal: 27 39 mL mH n1L n1H n2L n2H.....n1L n1h 13
 Hexadecimal: 1B 27 mL mH n1L n1H n2L n2H.....n1L n1h OD

Explanation:

This command is used to print curve along the paper-feeding direction. The value of m is the number of curves to be printed, m=0~255.

There are m dots of curve in one horizontal line. n1L n1H n2L n2H.....n1L n1H presents the positions of these m curves. The numbers of n1L or n1H should equal to m. Each dot should be within the largest dots numbers of printer. The last CR ("enter") is used to print out this dot line. The whole m curves are printed out through each dot line by n1L n1H n2L n2H.....n1L n1H data.

Remark: The dot whose position is beyond the paper width won't be printed out. This command is valid no matter there is OD or not.

ESC ,**Print Curve II (supplement dots automatically to be full curve)**

Format: ASCII: ESC , m n1L n1H n2L n2H.....n1L n1H CR
 Decimal: 27 44 m n1L n1H n2L n2H.....n1L n1h 13
 Hexadecimal: 1B 2C m n1L n1H n2L n2H.....n1L n1h OD

Explanation:

The using explanation is same as the command for Printing Curve I.

GS B n

[Name] Selecting/canceling black white revert printing mode

[Format] ASCII GS B n
 Hex 1D 42 n
 Decimal 29 66 n

[Range] $0 \leq n \leq 255$

[Description] Selecting/canceling black white revert printing mode

- When the lowest bit of n is 0,canceling black white reverse printing mode.
- When the lowest bit of n is 1,selecting black white reverse printing mode.

- [Note]
- Only the lowest bit of n is effective
 - This command is available to all the characters (except HRI characters)
 - After selecting black white reverse printing, the space between characters which is set by ESC SP command is also reversing.
 - This command does not influence bit map, user defined bit map, barcode, HRI character and blank space which is set by HT,ESC \$ and ESC\
 - This command does not influence the blank space between lines.
 - Priority of black white reverse printing mode is higher than it of underline

mode. When selecting black white reverse printing mode, underline mode is not effective. It will be effective after canceling black white reverse printing mode.

[Default value] n = 0

GS H n

[Name] Selecting the printing position of HRI character

[Format]	ASCII	GS	H	n
	Hex	1D	48	n
	Decimal	29	72	n

[Range] $0 \leq n \leq 3, 48 \leq n \leq 51$

[Description] When printing the barcode, selecting the printing position for HRI character

N appoints the printing position of HRI

n	Printing position
0, 48	No printing
1, 49	Above the barcode
2, 50	Below the barcode
3, 51	Both above and below the barcode

· HRI is the character of content note of barcode

[Note] · The style of HRI character is appointed by GS f.

[Default value] n = 0

[Reference] **GS f**, **GS k**

GS L nL nH

[Name] Setting left margin

[Format]	ASCII	GS	L	nL	nH
	Hex	1D	4C	nL	nH
	Decimal	29	76	nL	nH

[Range] $0 \leq nL \leq 255$

$0 \leq nH \leq 255$

[Description] · Setting left margin by nL and nH

· Setting left margin at $[(nL+nH \times 256) \times \text{horizontal motion unit}]$ inches.

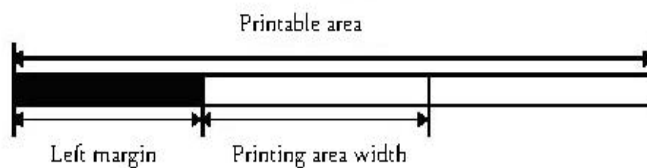

[Note] · This command is just available at the zero position of the line and under standard

· It is not available under page mode, the printer will handle it as normal data

- This command does not influence the printing under page mode
- Taking the Max width is it goes beyond the max printing width
- Vertical and horizontal motion units are set by GSP. Changing the motion will not influence the current left margin.

[Default value] nL = 0, nH = 0

[Reference] **GS P, GS W**

GS P x y

[Name] Setting horizontal and vertical motion units

[Format] ASCII GS P x y
 Hex 1D 50 x y
 Decimal 29 80 x y

[Range] $0 \leq x \leq 255$
 $0 \leq y \leq 255$

[Description] · Setting horizontal motion units as near 25.4/xmm (1/x inch) Setting vertical Motion units as near 25.4/ymm (1/y inch)

- When x and y are all 0, x and y are setting as default value

[Note] · Direction is perpendicular to the feeding is horizontal, the feeding direction is vertical
 · Under standard mode, making the character whirl by x or y(does not change if invert or clockwise rotates 90API)
 ① Using x command: ESC SP, ESC \$, ESC \, GS L, GS W
 ② Using y command: ESC 3, ESC J, GS V
 · Under page mode, according to the direction of printing and the starting position to use x or y

① When the starting position is set as top left corner or lower right by ESC T:

Using x command: ESC SP, ESC \$, ESC W, ESC \

Using y command: ESC 3, ESC J, ESC W, GS \$, GS \, GS V

② When the starting position is set as top right corner or lower left by ESC T:

Using x command: ESC 3, ESC J, ESC W, GS \$, GS \

Using y command: ESC SP, ESC \$, ESC W, ESC \, GS V

- This command does not influence other settings set before
- The minimum motion distance is the result of combined action of this and other commands
- a inch=25.4mm

[Default value] x=203,y=203,now a motion unit is a printing dot. Horizontal motion distance is 1/8mm,and vertical motion distance is 1/8mm.

[Reference] **ESC SP, ESC \$, ESC 3, ESC J, ESC W, ESC \, GS \$, GS L, GS V, GS W, GS **

①GS V m ②GS V m n

[Name] Select cutting mode and cut paper

[Format] ①ASCII GS V m

Hex	1D	56	m
Decimal	29	86	m
②ASCII	GS	V	m n
Hex	1D	56	m n
Decimal	29	86	m n

[Range] ① m = 0,48,1, 49

② m = 66, 0 ≤ n ≤ 255

[Description] Select one cutting mode and cut paper.

 Select cutting mode according to the value of m,as follows:

m	cutting mode
0,1,48,49	half cutting
66	Feed paper (cutting position+[n*(vertical shifting unit)inch]) and half cutting paper.

[Note ①and②]

·This command does effect only at the beginning of line.

[Note②]

- m = 0,48,1, 49, The printer cuts directly.
- When m=66,the printer feed paper[the distance from printing position to cut +n*(vertical motion unit)] then cut paper.
- The lateral and vertical shifting unit are set by the command GS P.
- The number of feeding paper is computed by vertical motion unit

GS f n

[Name] Selecting font of HRI used

[Format]	ASCII	GS	f	n
	Hex	1D	66	n
	Decimal	29	102	n

[Range] n = 0, 1, 48, 49

[Description] When printing barcode, selecting a style for HRI character

 Selecting style by n is as below:

n	Style
0,48	Standard ASCII character(12×24)
1,49	Compressed ASCII character(9×17)

[Note]

- HRI character is the note of barcode content
- HRI character printing position is set by GSH command

[Default value] n = 0

[Reference] **GS H, GS k**

GS h n

[Name] Selecting height of barcode

[Format]	ASCII	GS	h	n
	Hex	1D	68	n
	Decimal	29	104	n

[Range] $1 \leq n \leq 255$
 [Description] Selecting height of barcode
 The height of barcode is n dots
 [Default value] $n = 162$
 [Reference] **GS k**

①GS k m d1...dk NUL②GS k m n d1...dn

[Name] Printing barcode

[Format] ①ASCII GS k m d1...d k NUL
 Hex 1D 6B m d1...d k 00
 Decimal 29 107 m d1...d k 0
 ②ASCII GS k m n d1... dn
 Hex 1D 6B m n d1... dn
 Decimal 29 107 m n d1... dn

[Range] ① $0 \leq m \leq 6$ (Value range of k and d is decided by its type)
 ② $65 \leq m \leq 73$ (Value range of k and d is decided by its type)

[Description] Selecting a kind of barcode and printing

m is used to select type of barcode, as follows:

m	Barcode type	Number of character	d
①	0	UPC-A	$11 \leq k \leq 12$ $48 \leq d \leq 57$
	1	UPC-E	$11 \leq k \leq 12$ $48 \leq d \leq 57$
	2	JAN13 (EAN13)	$12 \leq k \leq 13$ $48 \leq d \leq 57$
	3	JAN 8 (EAN8)	$7 \leq k \leq 8$ $48 \leq d \leq 57$
	4	CODE39	$1 \leq k \leq 255$ $45 \leq d \leq 57, 65 \leq d \leq 90, 32, 36, 37, 43$
	5	ITF	$1 \leq k \leq 255$ $48 \leq d \leq 57$
②	6	CODABAR	$1 \leq k \leq 255$ $48 \leq d \leq 57, 65 \leq d \leq 68, 36, 43, 45, 46, 47, 58$
	65	UPC-A	$11 \leq n \leq 12$ $48 \leq d \leq 57$
	66	UPC-E	$11 \leq n \leq 12$ $48 \leq d \leq 57$
	67	JAN13 (EAN13)	$12 \leq n \leq 13$ $48 \leq d \leq 57$
	68	JAN 8 (EAN8)	$7 \leq n \leq 8$ $48 \leq d \leq 57$
	69	CODE39	$1 \leq n \leq 255$ $45 \leq d \leq 57, 65 \leq d \leq 90, 32, 36, 37, 43$ $d1 = d k = 42$
	70	ITF	$1 \leq n \leq 255$ $48 \leq d \leq 57$
	71	CODABAR	$1 \leq n \leq 255$ $48 \leq d \leq 57, 65 \leq d \leq 68, 36, 43, 45, 46, 47, 58$
	72	CODE93	$1 \leq n \leq 255$ $0 \leq d \leq 127$

[Note ①]

- This command is ended by NULL under this format
- When selecting code of UPC-A or UPC-E, after receiving 12 bytes data, printer will handle the rest as normal character
- When selecting type of JAN13(EAN13), after receiving 13 bytes data, printer will handle the rest as normal character
- When selecting type of JAN8(EAN8), after receiving 8 bytes data, printer will handle the rest as normal character
- Number of ITF code data must be an even number. If entering code data of odd number, the last data will be ignored

[Note ②]

- N is used to appoint the number of pointing barcode data. The printer will handle then byte data follow as barcode data
- If n goes beyond the specified range, the printer will not handle this command, and handle the data following as normal data

[Note(Standard mode)]

- If the barcode d goes beyond the specified range, this command is invalid.
- If the cross wise of barcode goes beyond printing area, invalid
- No matter what is the height set by ESC 2 or ESC 3, the distance of feeding paper is the
- This command only available when there is no data in printing buffer, if not, the command will be ignored. same as the height of barcode.

The printing position will be set at the beginning of the line after printing the barcode.

- Other mode setting (bold、 double printing、 underline、 character dimension、 inverse and character clockwise rotates 90 degree) can not influence this command except Inversion mode

[Note(page mode)]

- This command just produces the barcode figure in printing buffer, but not print. Moving the printing position to the right of the barcode after handling the barcode data.
- If the d goes beyond the specified range, this command will be ignored.
- If the width of the barcode goes beyond the printing area, this command will be ignored
- Referring appendix A, related information of CODE128 and character set
- When using CODE128, encoding according to the description following
 - ① Selecting character set before barcode data (CODE A、 CODE B or CODE C)
 - ② Selecting character set according to sending character “{” and combine with another character; ASCII character “{” is finished by sending character “{” for twice.

Appointing

Sending data

Character	ASCII	Hex	Decimal
SHIFT	{S	7B, 53	123,83
CODE A	{A	7B, 41	123, 65
CODE B	{B	7B, 42	123, 66
CODE C	{C	7B, 43	123, 67
FNC1	{1	7B, 31	123, 49
FNC2	{2	7B, 32	123, 50
FNC3	{3	7B, 33	123, 51
FNC4	{4	7B, 34	123, 52
"{"	{{	7B, 7B	123, 123

[Example] Printing "No.123456"

Using CODE B to print "No.", and then using CODE C to print the digital rest

GS k 73 10 123 66 78 111 46 123 67 12 34 56**GS k 73 10 123 66 78 111 46 123 67 12 34 56**



- If it is not character set selection at the beginning of barcode data, the printer will stop handling this command, and handling the rest data as normal data
- If "{" and the character close behind is not the combination as above, the printer will stop handling this command, and handling the rest data as normal data.
- If the character is not the data of barcode character set, the printer will stop handling this command, and handling the rest data as normal data.
- When printing HRI character, not printing shift character and character set selection data
 - HRI character of function character is not printed
 - HRI character of control character (<00>H to <1F>Hand <7F>H) is not printed

<Others> Ensure the left and right space of barcode. Space is different because of different barcode style.

[Reference] GS H, GS f, GS h, GS w, appendix A

GS w n

[Name]	Setting the width of barcode			
[Format]	ASCII	GS	w	n
	Hex	1D	77	n
	Decimal	29	119	n

[Range] $2 \leq n \leq 6$

[Description] Setting width of barcode horizontal module

Appointing the barcode horizontal module by n

n	Mono basis module width (mm)	Double basic module width	
		Narrow-based module (mm)	Wide-based module (mm)
2	0.25	0.25	0.625
3	0.375	0.375	1.0
4	0.5	0.5	1.25
5	0.625	0.625	1.625
6	0.75	0.75	1.875

·Barcode of mono basis module is as below:

UPC-A, UPC-E, JAN13 (EAN13), JAN8 (EAN8), CODE93, CODE128

·Barcode of biradical module is as below:

CODE39, ITF, CODABAR

[Default value] n = 2

[Reference] **GS k**

Two dimensional barcode control command

ESC Z m n k dL dH d1 ...dn

[Name] Print two dimensional barcode

[Format] ASCII ESC Z v r k nL nH d1 ...dn

Hex 1B 5A v r k nL nH d1 ...dn

Decimal 27 90 v r k nL nH d1 ...dn

[Description] According to the GS Z select barcode type print 2 d graphics, the parameter meaning varies according to the barcode type.

① PDF417 two dimensional barcode

$1 \leq v \leq 30$ Stand for the character number in a row. Because different models have different paper width, the maximum v should be within the aircraft allowed maximum.

$0 \leq r \leq 8$ Stand for error correction level

$1 \leq k \leq 6$ Stand for the longitudinal magnification.

$1 \leq dHdL \leq 65535$ Stand for printing the barcode data length is n, nL, nH is the low order and high order of n.

($n = dL + dH * 256$)

$0 \leq dn \leq 255$ Stand for the barcode data

③ DATAMATRIX two dimensional barcode

$0 \leq v \leq 144$ Stand for height of graphics (0: automatic selection)

$8 \leq r \leq 144$ Stand for width of graphics (v=0, invalid)

$1 \leq k \leq 6$ Stand for magnification
 $1 \leq dHdL \leq 65535$ Stand for printing the barcode data length is n, nL, nH is the low order and high order of n.
 ($n = dL + dH * 256$)
 $0 \leq dn \leq 255$ Stand for the barcode data
 ④ QR-CODE two dimensional barcode
 $0 \leq v \leq 40$ Stand for graphics version number (0: automatic selection)
 r =76,77,81, 72 Stand for error correction level (L:7%, M:15%,Q:25%,H:30%)
 $1 \leq k \leq 6$ Stand for magnification
 $1 \leq dHdL \leq 65535$ Stand for printing the barcode data length is n, nL, nH is the low order and high order of n.
 ($n = dL + dH * 256$)
 $0 \leq dn \leq 255$ Stand for the barcode data

GS Z n

[Name] Choose two dimensional barcode type
 [Format] ASCII GS Z n
 Hex 1D 5A n
 Decimal 29 90 n
 [Range] $0 \leq n \leq 2$
 [Description] Choose two dimensional barcode type
 n=0 Select PDF417
 n=1 Select DATAMATRIX
 n=2 Select QR-CODE

① GS k m v r d1...dn NUL②GS k m v r nL nH d1...dn

[Name] Printing two dimensional barcode
 [Format] ①ASCII GS k m v r d1...d n NUL
 Hex 1D 6B m v r d1...d n 00
 Decimal 29 107 m v r d1...d n 0
 ②ASCII GS k m v r nL nH d1... dn
 Hex 1D 6B m v r nL nH d1... dn
 Decimal 29 107 m v r nL nH d1... dn
 [Range] ① $32 \leq m \leq 34$
 ② $97 \leq m \leq 99$
 [Description] Select one type of two dimensional barcode and printing, when use选择 format one ,it ends as 00,d1....dn is the data of barcode. When select format 2, d1....dn is the data of barcode.
 m is used to select barcode type, as following:
m Barcode type
 ① 32 QR Code

- 33 Data Matrix
- 34 PDF417
- ② 97 QR Code
- 99 Data Matrix
- 98 PDF417

Different bar code has different parameters meanings.

① PDF417 two dimensional barcode

$1 \leq v \leq 30$ Stand for the character number in a row. Because different models have different paper width, the maximum v should be within the aircraft allowed maximum.

$0 \leq r \leq 8$ Stand for error correction level

$1 \leq dHdL \leq 65535$ Stand for printing the barcode data length is n, nL, nH is the low order and high order of n.

$$(n = dL + dH * 256)$$

$0 \leq dn \leq 255$ Stand for the barcode data

③ DATAMATRIX two dimensional barcode

$0 \leq v \leq 144$ Stand for height of graphics (0: automatic selection)

$8 \leq r \leq 144$ Stand for width of graphics (v=0, invalid)

$1 \leq dHdL \leq 65535$ Stand for printing the barcode data length is n, nL, nH is the low order and high order of n

$$(n = dL + dH * 256)$$

$0 \leq dn \leq 255$ Stand for the barcode data

③ QR-CODE two dimensional barcode

$0 \leq v \leq 40$ Stand for graphics version number (0: automatic selection)

$1 \leq r \leq 4$ Stand for error correction level (L:7%, M:15%, Q:25%, H:30%)

$1 \leq dHdL \leq 65535$ Stand for printing the barcode data length is n, nL, nH is the low order and high order of n.

$$(n = dL + dH * 256)$$

$0 \leq dn \leq 255$ Stand for the barcode data

[Note] Using the instruction to print two dimensional barcode, the barcode of magnification is decided by GS w command set n

[Reference] **ESC Z, GS w**

The Chinese characters controlling commands

FS ! n

[Name]	Setting Chinese characters mode			
[Format]	ASCII	FS	!	n
	Hex	1C	21	n
	Decimal	28	33	n

[Range] $0 \leq n \leq 255$

[Description] Using value of n to set the printing mode of Chinese characters

Bit	0/1	Hex	Decimal	Function
0, 1				Undefined
2	0	00	0	Canceling double width
	1	04	4	Selecting double width
3	0	00	0	Canceling double height
	1	08	8	Selecting double height
4-6				Undefined
7	0	00	0	Canceling underline
	1	80	128	Selecting underline

[Note]

- When double width and double height are set together, portrait and landscape will be enlarged two times together (including left and right space).
- Printer can add underline to all the characters, including left and right space. But can not add underline to the space caused by HT command (horizontal tab), either the 90 degree clockwise characters.
- The width of underline is set by FS - has no relation to the character

boundary

- When the height of the character in one line is not the same, all the characters align the base line
- Using FS W and GS ! can make the characters bold, the setting of the last received command is effective.
- Also can use FS to select or cancel the underline, the setting of the last received command is effective.

[Default value] n = 0

[Reference] **FS - , FS W, GS !**

FS &

[Name] Selecting Chinese character mode

[Format]

ASCII	FS	&
Hex	1C	26
Decimal	28	38

[Description] Selecting Chinese character mode

[Note]

- When select Chinese character mode, printer will judge whether the character is Hanzi internal code, if it is, dealing with the first byte in advance. Then the second one.

- After powering up, the printer will select Chinese character mode by itself.

[Reference] **FS . , FS C**

FS - n

[Name] selecting/canceling Chinese underline mode

[Format]

ASCII	FS	-	n
Hex	1C	2D	n
Decimal	28	45	n

[Range] $0 \leq n \leq 2, 48 \leq n \leq 50$
[Description] selecting or canceling Chinese underline according to value of n

n	Function
0, 48	canceling Chinese underline
1, 49	selecting Chinese underline (1dot width)
2, 50	selecting Chinese underline (2dots width)

[Note] · Printer can add underline to all the characters, including left and right space. But can not add underline to the space caused by HT command(horizontal tab),either the 90 degree clockwise characters.
· It does not carry out the underline printing after canceling underline mode,but the previous set does not change.The default underline width is 1dot.
· The underline width does not change even if changing the character dimension.
· Can use FS ! to select or cancel the underline, the setting of the last received command is effective

[Default value] n = 0

[Reference] **FS !**

FS .

[Name] canceling chinese mode

[Format]	ASCII	FS	.
	Hex	1C	2E
	Decimal	28	46

[Description] canceling chinese mode

[Note] · When the Chinese mode is canceled, all the characters are the same as ASCII style, and deal with one byte once.
· Selecting Chinese mode when power on.

[Reference] **FS &, FS C**

FS 2 c1 c2 d1...dk

[Name] Defining user self-defined Chinese

[Format]	ASCII	FS	2	c1	c2	d1...dk
	Hex	1C	32	c1	c2	d1...dk
	Decimal	28	50	c1	c2	d1...dk

[Range] c1,c2 represent the code of defined characters.
c1 = FEH
 $A1H \leq c2 \leq FEH$
 $0 \leq d \leq 255$
k = 72

[Description] Defining the Chinese specified by c1,c2.

[Note] · C1,c2 represent user self-defined Chinese code,c1 specifies the first

byte,c2 specifies the second byte.

·D represent data.Every bit of byte is 1 represents to print the dot,0 means does not print.

·It can define 10 chinese the most.

[Default value] no self-defined Chinese

The relation between self-defined Chinese font and data as follows:

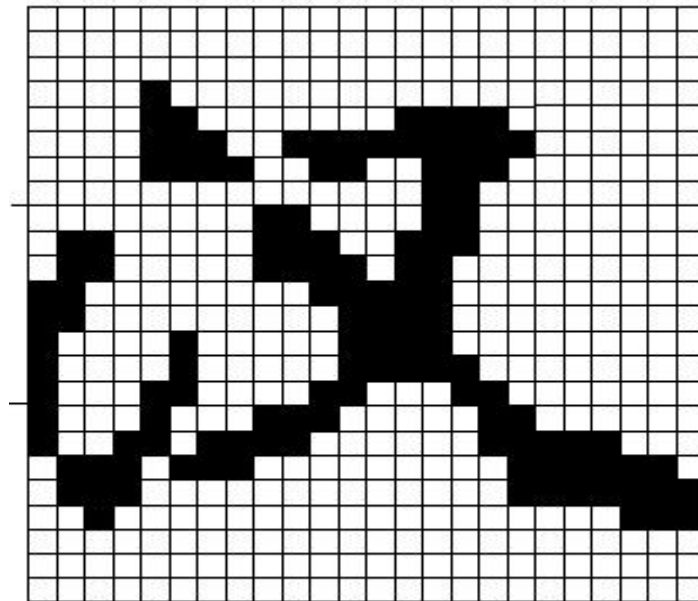
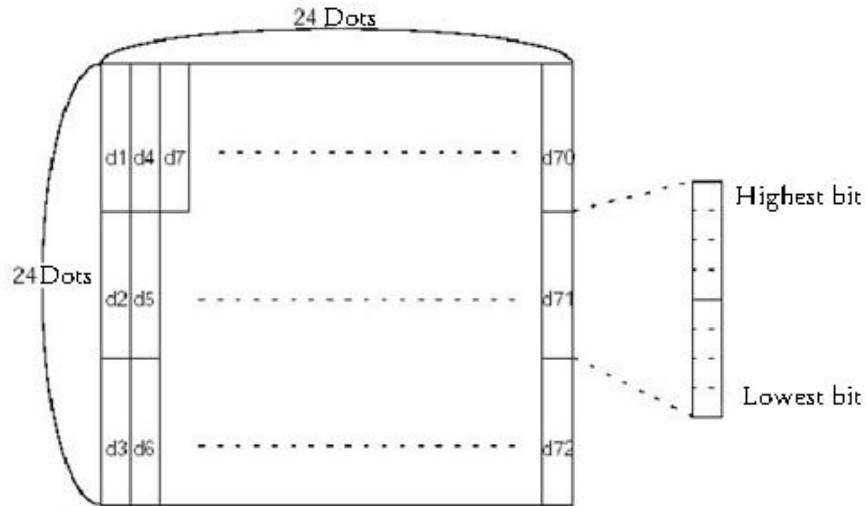

D1=00H, D4=00H, D7=00H, D10=00H.
 D2=1FH, D5=78H, D8=60H, D11=00H.
 D3=C0H, D6=30H, D9=38H, D12=70H.

FS C n

[Name] selecting Chinese code system
 [Format] ASCII FS C n1 n2

	Hex	1C	43	n1	n2
	Decimal	28	67	n1	n2
[Range]	n=0,1,48,49				
[Description]	selecting Chinese code system				
	n	selecting Chinese code system			
	0, 48	Simplified Chinese (GB2312或GB18030)			
	1, 49	Traditional Chinese-TC (BIG5)			
[Note]	<ul style="list-style-type: none"> · The command does not change the parameter set of flash · It returns to default after carried out ESC @ command、 power off or reset. 				
[Default value]	n = 0 Simplified Chinese model.				
	n = 1 Traditional Chinese-TC model				

FS S n1 n2

[Name]	Setting the left and right space of Chinese character				
[Format]	ASCII	FS	S	n1	n2
	Hex	1C	53	n1	n2
	Decimal	28	83	n1	n2
[Range]	0 ≤ n1 ≤ 255				
	0 ≤ n2 ≤ 255				
[Description]	Setting the space of left and right are n1,n2. <ul style="list-style-type: none"> · When the printer have GSP command, the left space is[n1*lateral or vertical motion unit] inch, the right space is[n2*lateral or vertical motion unit]inch. 				
[Note]	<ul style="list-style-type: none"> · The left and right space will be doubled after setting the double width mode. · The shifting unit is set by the command GS P. The former character space does not change even if the lateral and vertical units are changed. · Using the lateral shifting unit under the standard mode. · Selecting to use the lateral or vertical shifting unit according to the printing area under page mode. <ol style="list-style-type: none"> ① Using horizontal shifting when the beginning position is the top left or lower right corner of the printing area ② Using vertical shifting when the beginning position is the lower left or top right corner of the printing area The maximum distance of Chinese is36mm.If it is beyond this distance, taking the maximum distance. 				
[Default]	n1 = 0, n2 = 0				
[Reference]	GS P				

FS W n

[Name]	Selecting/canceling Chinese double height or width			
[Format]	ASCII	FS	W	n
	Hex	1C	57	n

	Decimal	28	87	n
[Range]		0 ≤ n ≤ 255		
[Default]	Selecting/canceling Chinese double width mode			
	<ul style="list-style-type: none"> · Cancel chinese double width mode when the lowest bit is 0 · Select Chinese double width mode when the lowest bit is 1. 			
[Note]	<ul style="list-style-type: none"> · only the lowest bit of n is effective. · To print chinese dimension under double width mode is the same as to select both double width and double height. · The Chinese dimension is printed normally after cancelling the Chinese double width mode. · When the height of the character in one line is not the same, all the characters align the baseline · Also using FS! or GS! can select or cancel Chinese double height and width mode, the setting of the last received command is effective. 			
[Default]		n = 0		
[Reference]		FS !, GS !		

Appendix A: 128 code

A.1 128 code summary

128code can code 128ASCII characters and 100 numbers from 00~99 and some special character by crossing using of character set A, B and C. Character of every character set code is as below:

Character set A: ASCII character from 00H to 5FH

Character set B: ASCII character from 20H to 7FH

Character set C: 100 numbers from 00~99

128 code can also code to the special character below:

SHIFT character

“SHIFT” can make barcode character the first character after SHIFT character transfer from character set A to B, or B to A, back to the character set used before SHIFT. “SHIFT” Character can only be used to transform between character set A and B, it can not make the current code character enter or quit state of character set C.

Selecting character of character set (CODEA、CODEB、 CODEC)

These characters can transform the coding character followed to character set A,B or C.

Function character (FNC1、 FNC2、 FNC3、 FNC4)

Usage of these function character is determined by application software. Only FNC1 can be used in character set C.

A.2 Character sets

Character in set A

Character	Sending data		Character	Sending data		Character	Sending data	
	Hex	Decimal		Hex	Decimal		Hex	Decimal
NULL	00	0	(28	40	P	50	80
SOH	01	1)	29	41	Q	51	81
STX	02	2	*	2A	42	R	52	82
ETX	03	3	+	2B	43	S	53	83
EOT	04	4	,	2C	44	T	54	84
ENQ	05	5	-	2D	45	U	55	85
ACK	06	6	.	2E	46	V	56	86
BEL	07	7	/	2F	47	W	57	87
BS	08	8	0	30	48	X	58	88
HT	09	9	1	31	49	Y	59	89
LF	0A	10	2	32	50	Z	5A	90
VT	0B	11	3	33	51	[5B	91
FF	0C	12	4	34	52	\	5C	92
CR	0D	13	5	35	53]	5D	93
SO	0E	14	6	36	54	^	5E	94
SI	0F	15	7	37	55	_	5F	95
DLE	10	16	8	38	56	FNC1	7B,3	123,49
DC1	11	17	9	39	57	FNC2	1	123,50
DC2	12	18	:	3A	58	FNC3	7B,3	123,51
DC3	13	19	;	3B	59	FNC4	2	123,52
DC4	14	20	<	3C	60	SHIFT	7B,3	123,83
NAK	15	21	=	3D	61	CODEB	3	123,66
SYN	16	22	>	3E	62	CODEC	7B,3	123,67
ETB	17	23	?	3F	63		4	
CAN	18	24	@	40	64		7B,5	
EM	19	25	A	41	65		3	
SUB	1A	26	B	42	66		7B,4	
ESC	1B	27	C	43	67		2	
FS	1C	28	D	44	68		7B,4	
GS	1D	29	E	45	69		3	
RS	1E	30	F	46	70			
US	1F	31	G	47	71			
SP	20	32	H	48	72			
!	21	33	I	49	73			
"	22	34	J	4A	74			
#	23	35	K	4B	75			
\$	24	36	L	4C	76			
%	25	37	M	4D	77			
&	26	38	N	4E	78			

'	27	39	O	4F	79			
---	----	----	---	----	----	--	--	--

Character in set B

character	Sending data		character	Sending data		character	Sending data	
	Hex	Decimal		Hex	Decimal		Hex	Decimal
SP	20	32	H	48	72	p	70	112
!	21	33	I	49	73	q	71	113
"	22	34	J	4A	74	r	72	114
#	23	35	K	4B	75	s	73	115
\$	24	36	L	4C	76	t	74	116
%	25	37	M	4D	77	u	75	117
&	26	38	N	4E	78	v	76	118
'	27	39	O	4F	79	w	77	119
(28	40	P	50	80	x	78	120
)	29	41	Q	51	81	y	79	121
*	2A	42	R	52	82	z	7A	122
+	2B	43	S	53	83	{	7B,7B	123,123
,	2C	44	T	54	84		7C	124
-	2D	45	U	55	85	}	7D	125
.	2E	46	V	56	86	—	7E	126
/	2F	47	W	57	87	DEL	7F	127
0	30	48	X	58	88	FNC1	7B,31	123,49
1	31	49	Y	59	89	FNC2	7B,32	123,50
2	32	50	Z	5A	90	FNC3	7B,33	123,51
3	33	51	[5B	91	FNC4	7B,34	123,52
4	34	52	\	5C	92	SHIFT	7B,53	123,83
5	35	53]	5D	93	CODEA	7B,41	123,65
6	36	54	^	5E	94	CODEC	7B,43	123,67
7	37	55	—	5F	95			
8	38	56	`	60	96			
9	39	57	a	61	97			
:	3A	58	b	62	98			
;	3B	59	c	63	99			
<	3C	60	d	64	100			
=	3D	61	e	65	101			
>	3E	62	f	66	102			
?	3F	63	g	67	103			
@	40	64	h	68	104			
A	41	65	i	69	105			
B	42	66	j	6A	106			
C	43	67	k	6B	107			
D	44	68	l	6C	108			
E	45	69	m	6D	109			
F	46	70	n	6E	110			
G	47	71	o	6F	111			

Character in set C

Character	Sending data		Character	Sending data		Character	Sending data	
	Hex	Decimal		Hex	Decimal		Hex	Decimal
0	00	0	40	28	40	80	50	80
1	01	1	41	29	41	81	51	81
2	02	2	42	2A	42	82	52	82
3	03	3	43	2B	43	83	53	83
4	04	4	44	2C	44	84	54	84
5	05	5	45	2D	45	85	55	85
6	06	6	46	2E	46	86	56	86
7	07	7	47	2F	47	87	57	87
8	08	8	48	30	48	88	58	88
9	09	9	49	31	49	89	59	89
10	0A	10	50	32	50	90	5A	90
11	0B	11	51	33	51	91	5B	91
12	0C	12	52	34	52	92	5C	92
13	0D	13	53	35	53	93	5D	93
14	0E	14	54	36	54	94	5E	94
15	0F	15	55	37	55	95	5F	95
16	10	16	56	38	56	96	60	96
17	11	17	57	39	57	97	61	97
18	12	18	58	3A	58	98	62	98
19	13	19	59	3B	59	99	63	99
20	14	20	60	3C	60	FNC1	7B,31	123,49
21	15	21	61	3D	61	CODEA	7B,41	123,65
22	16	22	62	3E	62	CODEB	7B,42	123,66
23	17	23	63	3F	63			
24	18	24	64	40	64			
25	19	25	65	41	65			
26	1A	26	66	42	66			
27	1B	27	67	43	67			
28	1C	28	68	44	68			
29	1D	29	69	45	69			
30	1E	30	70	46	70			
31	1F	31	71	47	71			
32	20	32	72	48	72			
33	21	33	73	49	73			
34	22	34	74	4A	74			
35	23	35	75	4B	75			
36	24	36	76	4C	76			
37	25	37	77	4D	77			
38	26	38	78	4E	78			
39	27	39	79	4F	79			

Appendix B: the pre-print black mark description

User must obey the specification as follows when printing the black mark if wants to use pre-print black mark to progress note clamping,
Otherwise may cause printer can not identify a black mark. The black mark pre-print specification:

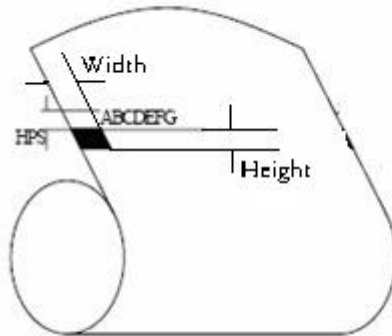

Printed location :is shown as chart above ,the black mark should be printed to character surface of right or left side rim.

Width range: $\text{width} \geq 7\text{mm}$

Height range: $4\text{mm} \leq \text{Height} \leq 6\text{mm}$

Vs the reflectivity of infrared: $< 10\%$ (the paper black mark width other fractions for the reflectivity of infrared $> 65\%$)

HPS:HPS marks the last rim to be apart from the distance of printing the origin top rim for printer black. $4.5\text{mm} \leq \text{HPS} \leq 6.5\text{mm}$