

SPRT®

SP-T7 Portable Dot Matrix Printer

User's Manual

VER 1.03

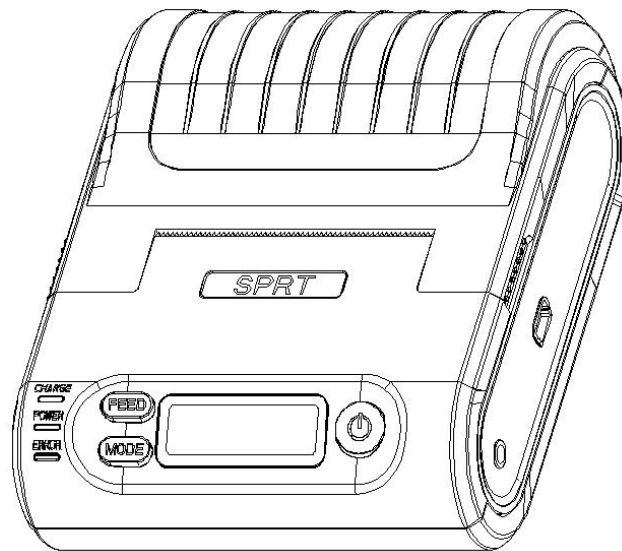

Beijing Spirit Technology Development Co., Ltd

www.sprt-printer.com

ONTENTS

NOTICE.....	1
Notice of Safety.....	1
Notice of Using.....	1
Notice of Storing.....	1
Declaration.....	2
Chapter 1 Appearance and Model No.....	2
1.1 Outer Appearance.....	2
1.2 Model No.....	2
Chapter 2 Characteristic Specification.....	2
2.1 Printing Specification.....	2
2.2 Physical parameter.....	3
2.3 Environmental parameter.....	3
2.4 Other Specification.....	3
Chapter 3 Operation Method.....	3
3.1 Using Preparation.....	4
3.1.1 Battery Installation.....	4
3.1.2 Paper Roll Installation.....	4
3.1.3 Others.....	5
3.2 Basic function usage.....	5
3.2.1 Switch On.....	5
3.2.2 Switch Off.....	5
3.2.3 Paper Feeding (Manual Feeding).....	5
3.2.4 Self-Test.....	6
3.2.5 Hexadecimal Printing.....	6
3.2.6 Printer Parameters Setting.....	6
3.2.7 Battery Charging.....	6
3.3 Printer Parameters Setting.....	7
3.4 Printer Interface Connection and Printing.....	7
3.4.1 USB Connection.....	7
3.4.2 Bluetooth Connection.....	7
3.4.3 Address Binding of Bluetooth.....	7
3.4.4 RF Connection.....	8
3.5 Indicator and Buzzer.....	8
One low one high: power on;.....	9
One high one low: power off;.....	9
3.6 LCD Indicator.....	9
Chapter 4 Other Information.....	10
4.1 Command Programming Manual.....	10
4.2 Description of Black Mark Pre-print.....	10
APPENDIX.....	11

NOTICE

Please read this manual carefully before using the printer!

Notice of Safety

Be sure to use the specified battery and power supply provided by our company. Otherwise it may cause fire, explosion or damage printer, meanwhile, the battery also may be damaged.

Don't put battery into the fire, don't disassemble or heat the battery, don't be short circuit, it may cause fire, explosion or damage printer, meanwhile, the battery also may be damaged.

If the printer would not be used for a long time, be sure to take off the battery, otherwise the battery may leak liquid which is corrosive liquid, if improper operation causes battery leak liquid, and it paste in the skin or clothes, please rinse it by clean water, if paste in the eyes, please rinse them thoroughly by clean water and see a doctor.

Please do not open the paper case cover when it is printing or just when printing is finished, do not touch the printer head with hand or body, overheat may cause scald.

Notice of Using

Water or other liquid should not be spilled into the printer, also the printer should not be appeared in the rain, or else may cause printer damage.

Please do not open the paper case cover when it is printing, otherwise the printer may work improperly.

If printer is using USB connection to work, should not unplug the USB cable, or else some printing data may be lost. When printer is using USB connection to work, the distance of communication should be within 10 meters, otherwise the printer doesn't print or prints rubbish codes.

Although the printer can work in temperature between 0°C to 5°C, too high (45°C) or too low (5°C) environment temperature will have influence on the quality of printing.

Too high (85%) or too low (20%) environment humidity both effect the printing quality.

The printer paper roll with poor quality or stored for too long time also may reduce the printing quality even damage the printer. Under the black mark detecting mode, the printer requires that the pre-printed black mark is accordant with the printing rule of black mark (please refer to details in Chapter 4.2), otherwise the black mark can not be detected correctly.

Be sure to run out of the power of the battery before charge up it, which can ensure the usage life of the battery.

Notice of Storing

The printer should be placed in such an environment that the temperature is between -20°C and 60°C, and the relative humidity is between 10% and 90%.

If the printer will be stored for a long time, please be sure to take out the battery, otherwise may damage the battery and printer.

Declaration

This product is “A” grade. In a domestic environment this product may cause radio interference in which case the user may need to perform practical actions.

Chapter 1 Appearance and Model No.

1.1 Outer Appearance

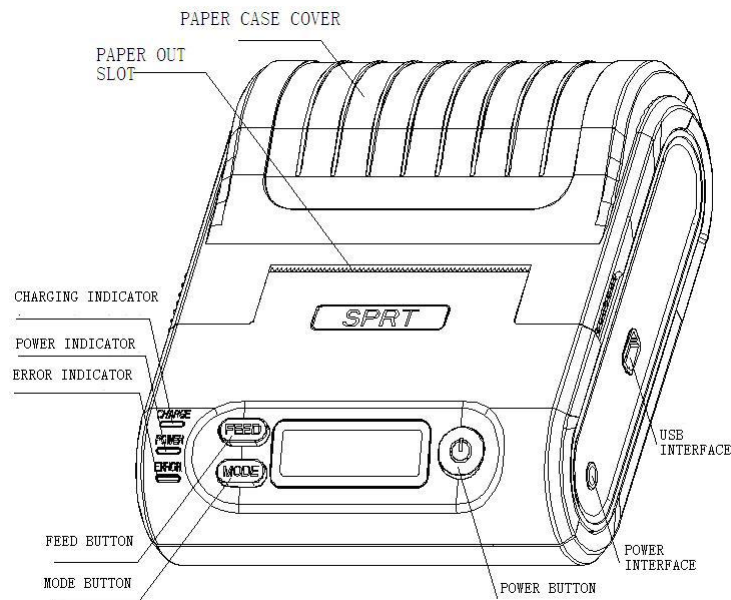

【CHARGE】:Battery Charging Indicator, 【ERROR】: Error Indicator,
【POWER】: power indicator, 【FEED】:Feed Button
【MODE】:Mode Button.

1.2 Model No.

SP-T7 Support USB Interface
SP-T7BT Support USB and Bluetooth Interface
SP-T7BTDM Support USB and Bluetooth Interface
SP-T7i Support USB and Bluetooth Interface
SP-T7RF Support USB and RF Interface

Chapter 2 Characteristic Specification

2.1 Printing Specification

Printing Method:Dot matrix;

Paper Width:57.5±0.5mm;

Effective Printing Width:48mm;

Resolution:5 dot/mm (127dpi);

Dots per line:240 dots;

Printing Speed:MAX 14.4 dot lps±20% (5.5mm/s);

Paper Thickness:0.06~0.08mm;

Character Set: GB18030 and BIG5 (16*16 and 12*12) (Chinese), ASCII (8*16 and 6*12), User-defined

ANK set: ASCII, Codepage and International character sets

2.2 Physical parameter

Outer Dimension:122 (L) ×98 (W) ×47 (H) mm;

Weight:347g (without paper roll and battery) ;

Paper Type: plain paper 58x φ40mm (MAX)

Interface: USB, Bluetooth, RF;

Printing Head Life: 1,500,000lines

2.3 Environmental parameter

Operating Temp:0°C~50°C;

Operating Humidity:10%~80%;

Storage Temp:-20°C~60°C;

Storage Humidity:10%~90%

2.4 Other Specification

Paper Loading Method: shell type paper loading (please refer to details in 3.1.2 Paper Roll Installation).

Paper cutting method: Manual

Black Mark Location: available (details please see 4.2 pre-printing black mark manual).

Printing Control Command: ESC/POS compatible command set (refer to<T7 Commands Manual >).

Power Supply: 7.4VDC/1500mAh rechargeable polymer lithium battery.

Power Alarm: when the battery is low, the battery indicator blinks

Battery Charging: quick charging. it will be charged fully about 4 hours;

Battery Duration: under 25% printing density, at least 30 meters. The standby time is over 35 hours. These parameters are just for reference, long term usage will cause the capacity decline, and can not ensure the time of printing.

Chapter 3 Operation Method

3.1 Using Preparation

3.1.1 Battery Installation

1. Put the battery into the battery slot.
2. Install the battery cover.

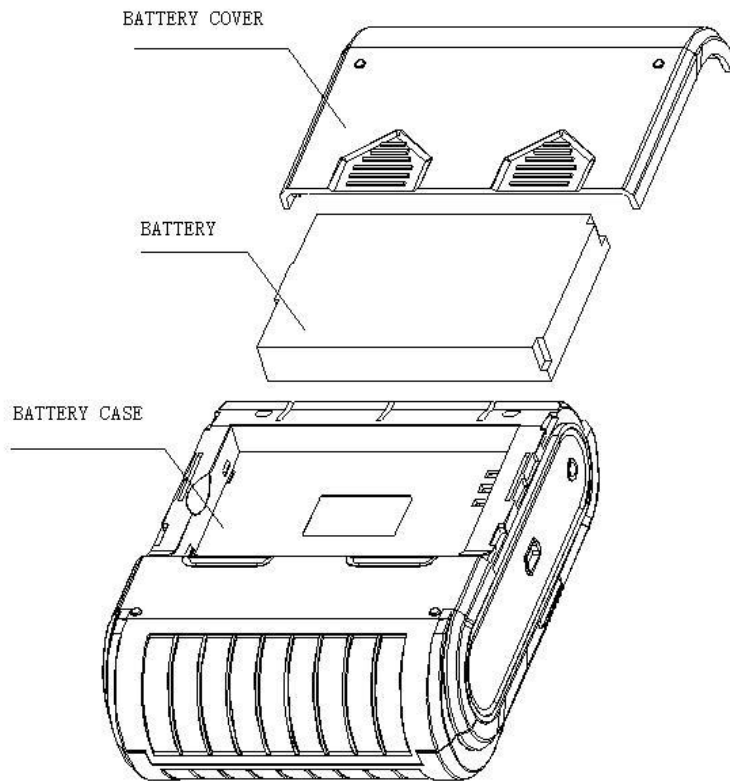

3.1.2 Paper Roll Installation

1. Hold both sides of the paper case cover, and open it.
2. Put in the new paper roll
3. Insert the paper into the feeding part, it's semi-auto loading.
4. Shut down paper case cover and cut off the redundant paper

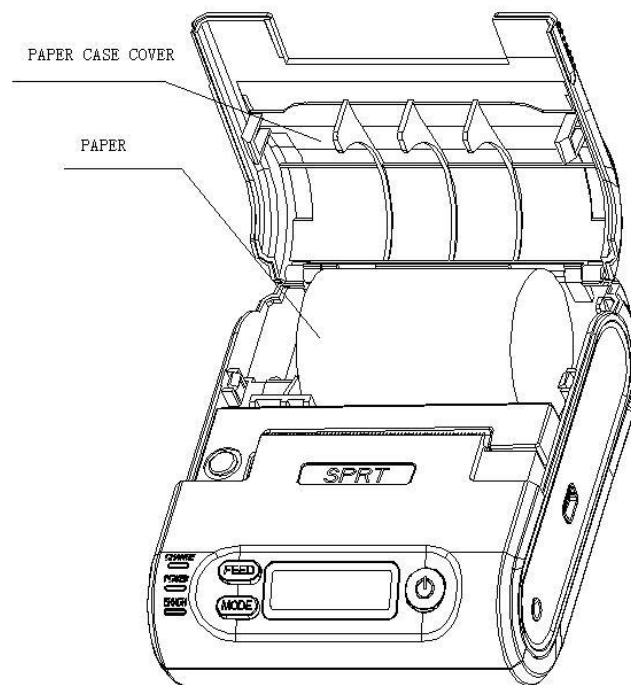



3.1.3 Others

Opening and closing instructions: closing slowly by two hands

Abnormal operation instructions: No blocking paper on the paper outlet

Paper direction: Holding the printer in a flat-wise orientation during printing. Keep steady when running paper.

3.2 Basic function usage

3.2.1 Switch On

Press **【POWER】** button, the power indicator is on, about 1 second later you will hear 'one low one high' prompt tone. The printer will turn into work mode when loosen the **【POWER】** button. The LCD screen show operating parameters of printer

3.2.2 Switch Off

Under status of switch on ,the printer will send out the prompt tone of 'one low one high ' after pressed the**【POWER】**button for 1 second, the power indicator go out, then loosen the **【POWER】** button, the printer is off.

3.2.3 Paper Feeding (Manual Feeding)

Under the normal work status, press **【FEED】** button, the paper feeding begins, and stop when loosen **【FEED】** button. When the printer works in black mark mode, press**【FEED】** button, the printer begins to feed paper and stops over the position of black mark. If the paper is not the black mark paper, the printer stops automatically after feeds paper for 30cm. Being out of paper, insert paper into paper port , the printer stops automatically after feeds paper for 10 cm.

3.2.4 Self-Test

After receiving the printer, user can check its current setting and status at anytime. Self-test way is as below: Power off, then hold down the **【FEED】** button and press the power button at the same time. Then loosen the **【FEED】** button when you hear 'one low one high 'prompt tone, the current setting and status will be printed out.

3.2.5 Hexadecimal Printing

The function of hexadecimal printing is to print the information received from host machine by hexadecimal numbers and corresponding characters. It will be convenient to debug application.

Into hexadecimal printing: Power off, hold down the **【MODE】** button and press the power button at the same time. Then loosen the power button and press the **【FEED】** button when you hear 'one low one high' prompt tone of power on. After that you may loosen the **【MODE】**button and **【FEED】** button. The printer turns into the hexadecimal printing mode

and print the presentation.

Exit hexadecimal printing: The way to quit hexadecimal printing mode is switch off the printer or press the 【FEED】 button for three times. The printer will also print the presentation which shows that the printer have exited hexadecimal printing mode.

3.2.6 Printer Parameters Setting

This function may set some simple printing parameters.

Entering parameter setting: Switch off, then hold down the 【FEED】 button and press the 【POWER】 button at the same time. Then loosen the 【POWER】 button and 【MODE】 button when you hear 'one low one high 'prompt tone. The printer turns into the parameters setting mode.

Print out the first item which can be set parameters and the current numerical value. Please see details in the appendix as below.

Quitting parameter setting: Hold down 【MODE】 and 【FEED】 buttons, then loosen 【MODE】 button and 【FEED】 button. Saving the set parameter and exiting the parameter setting mode. The setting parameters won't be saved if you directly press the 【POWER】 button to turn off the printer.

3.2.7 Battery Charging

The battery will run out after a period of usage. When it nearly runs out, printer will give a alarm through the battery indicator flashing, at this time, user needs to charge up the battery

The charging method is as following: connecting the adapter to the power socket with 220V, 50HZ, then plug the power charging plug to the power socket of the printer, so the power charging begins. During the course of power charging, the charging indicator 【CHARGE】 goes red, and 【CHARGE】 turns to green when the charging is full. It takes about 4 hours to charge up the battery. Using the printer during charging, it will take longer time to fully charged. It means malfunction of charging the battery if the charging indicator 【CHARGE】 goes with two color (green and red) during the course of charging. Such as faulty installation of battery, faulty contact of battery or internal temperature of battery is too high or too low.

3.3 Printer Parameters Setting

Users can set more parameters by using the specified 〈T7 Setting Tools〉 software through computer. The setting includes: language, font, printing density, default code page, Bluetooth device name and password (only T7-BT) etc. The setting method please refer to the <T7 Setting Tools Software Help>, offered with the software together.

3.4 Printer Interface Connection and Printing

3.4.1 USB Connection

The T7 printer of standard accessories includes Mini USB cable which connects printer. The USB type belongs to the slave device type.

3.4.2 Bluetooth Connection

Hand held device, laptop and other information terminal devices with Bluetooth can drive T7 to print by the Bluetooth interface. T7 portable printer is compatible with Bluetooth 2.0 standard and

Bluetooth with two models (IOS 4.0 and Android 4.0 Bluetooth standards). Power class is CLASS 2, effective communication distance is 10 meters. The Bluetooth of the printer belongs to the slave device. The initial name of the printer is "T7 BT Printer", the initial password is '1234'. Users can change the printer name and password by using <T7 Setting Tools> software. Details can be referred to the file of <T7 Setting Tools> usage specification.

Before working, T7 Portable Thermal Printer need to be pairing with primary device, matching begins with the host device. Usual matching course is as below:

1. Switch on printer;
2. Host device searches for the outer Bluetooth device;
3. If there are other Bluetooth devices, please select T7 BT Printer;
4. Enter the password '1234';
5. Pairing finished.

Please check details in primary device Bluetooth function instruction for reference.

Notice:

- 1, When pairing, please make SP-T7BT printer under the state of Power-on.
2. Once T7 has paired with the host successful, it can't be paired with other Bluetooth device until it unconnected with the host.
- 3, The power indicator flashing after paired successful.

3.4.3 Address Binding of Bluetooth

Bluetooth Binding: once the printer remembers the device's address, it only can connect with the first device and can't connect with others. So in this case, if the printer needs to connect with other devices, user can delete the remembered address or set the mode is not binding.

No binding: in this case, the printer can be searched or paired by other devices.

So when the printer needs to connect with a fixed device, it would be better to bind address.

Please see the details in help file of<T7 Setting Tools>

3.4.4 RF Connection

Information terminal devices with RF can drive T7RF to print by RF .It adopt 2.4Ghz global open ISM band which is license-exempt. With maximum operating speed of 2Mbps, efficient GFSK modulation and strong anti-jamming ability it is particularly suitable for industrial control .It can also satisfy multi-point communications and frequency hopping communication with 126 channels. Same communication frequency, consistent address and compatible communication protocols are required when using the printer. (You can consult our technicians for detailed usage rules)

3.5 Indicator and Buzzer

There are three indicators, they are red and green bi-colour【CHARGE】light, red【ERROR】light, and green 【POWER】 indicator. The meanings of each indicator are as below:

【POWER】 indicator

Long bright: printer is power-on, Bluetooth is with disconnect status

Light flashing: printer is power-on, Bluetooth is with connection status

【CHARGE】 indicator

Green light: fully-charged;





Red light: charging;

Green and red bi-colour: there are some mistakes, please check whether the battery should be good contact or not, and the temperature of battery is normal or not.

【ERROR】 indicator

Long bright: printer is out of paper

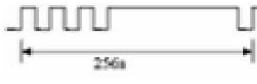
Flashing: flashing several times and constant light, then again flash and light. Different ways of flashing means the different errors:

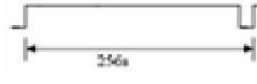
Error	Description	The flashing way of [ERROR] light
Memory error	The printer can't work normally after the memory need to be read-write calibration	
High voltage	The voltage of power is too high	
Low voltage	The voltage of power is too low	
Wrong operating of CPU	The CPU runs with wrong address	
Printer head faults	Printer head faults	

There is also a buzzer to indicate various status of the printer. The meanings are as below:

One low one high: power on;

One high one low: power off;



Circulation continuous two lows: printer at mistakes status

3.6 LCD Indicator

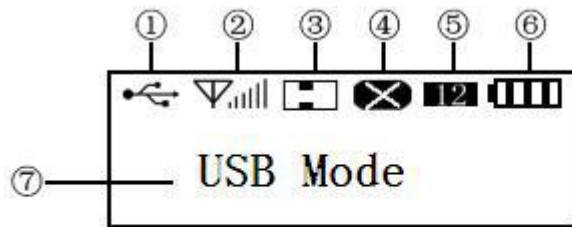

Turn on the printer, it will show " Loading". After initialization, LCD Screen in printer will show some information. If there is no data sent to printer or no interfaces connected to the printer in 5 seconds, the screen will close automatically. Until there is data sent to printer or interfaces are connected to printer, the screen will show as following:







① It means the USB interface is available.





② When it shows “ ”, it means RF is usable. When it shows  , it means Bluetooth working. If it show nothing, it means wireless interface is useless.

Notice:blue teeth and RF interface can not be used together .

③ Hexadecimal mode and Black Mark mode, When it shows  , it means under Black Mark mode; if it shows  , it means under hexadecimal mode.

④ Error status, when it shows  , it means the error status. When this picture flashes, the detailed error information will be showed by characters under this picture.

⑤ Default printing character font dots, when it shows  , it means the character font is 6*12/12*12; when it shows  , it means 8*16/16*16. when it shows  , it means : 7*9.
Notice:if you change the language of printing, icons wont change.

⑥ The current electric qty in battery. It showed in differently pictures:  ,  ,  .when the power is low, it will show  . In each situation. it will shows  when it connected to power.

⑦ Shows the printer situation through characters.

When printer is not connected, it show the USB mode.

When connected to USB, it shows USB has been connected .

When data are sent to printer through USB, it will show USB is communicating .

When printer connected through Bluetooth and the corresponding ports are open, it will show Bluetooth is connected.

When printer connected through both USB and Bluetooth interface, it will show USB and blue tooth are connected .

When data is sent to printer through Bluetooth, it will show: Bluetooth is communicating.

When data is sent to printer through RF interface, it will show the RF interface is communicating.

When printer goes wrong, it may show being out of paper, printer head is wrong, too high or low voltage.

When it is in the mode of settings, it will show :



▼ is corresponding with button 【FEED】 , it is used to chose the setting parameters .

● is corresponding with button 【MODE】 , it is used to chose the setting parameters .

After settings, press both【FEED】and【MODE】buttons to save the settings, and enter the normal switched on situation, or it cannot be saved.

In this screen, either 【FEED】 or 【MODE】 button is pressed can enter into the first setting parameter mode. For more detailed setting methods, you can find in the appendix.

Chapter 4 Other Information

4.1 Command Programming Manual

<T7Technical Manual> is a technical manual for engineer to develop printer utility, and users can claim our company for it. This manual including the technical description of hardware interface (Bluetooth, USB interface), technical documentation of printing control command set, and others such as how to print black mark and locate by it.

4.2 Description of Black Mark Pre-print

If user use pre-print black mark to locate the receipt, please be sure to abide by the following black mark pre-print regulation when print the black mark paper, if not, it will cause that the printer can not identify the black mark.

The black mark pre-print regulations are as below:

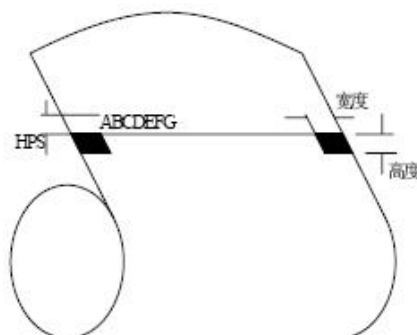

Printing Position: As the picture above, the black mark should be printed on the right or left edge of the side of words.

Width range: width \geq 7mm

Height range: $4\text{mm} \leq \text{height} \leq 6\text{mm}$

Reflectivity of infrared ray : $<10\%$ (infrared ray reflectivity of other parts of the black mark paper is $> 65\%$)

HPS: it is the distance between edges of black mark and loading position.

$4.5\text{mm} \leq \text{Hps} \leq 6.5\text{mm}$

APPENDIX

Appendix is the usage of setting printer parameter: this method is shown by picture.

【MODE】is to select settings. Every time【MODE】button is pressed, setting item changes to the next, and current setting data will be showed.

【FEED】button is to select the setting options. Every time【FEED】 button is pressed, the setting option changes to the next.

After finish setting, press both 【MODE】 and 【FEED】 button to save the settings, otherwise the setting will not saved.

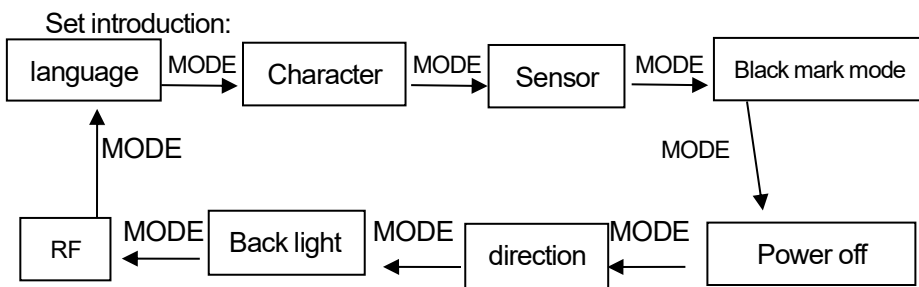

Language :

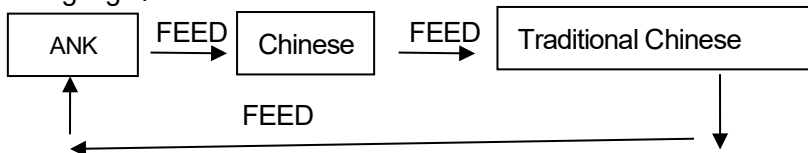

Character :

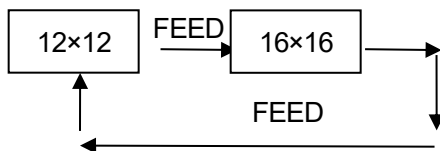

Sensitivity of sensor:

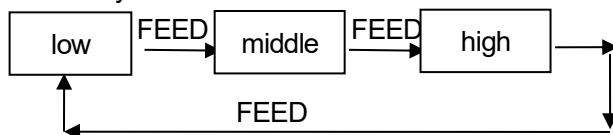

Black mode

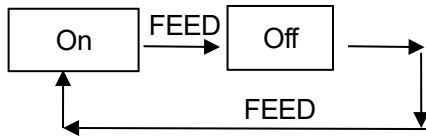

Off

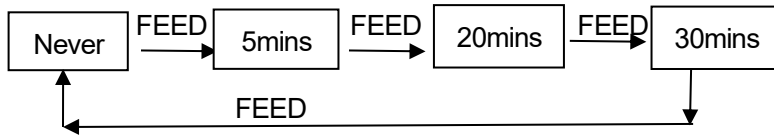

Direction :

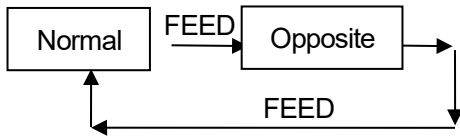

Back light set :

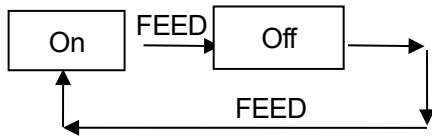

RF Ad:

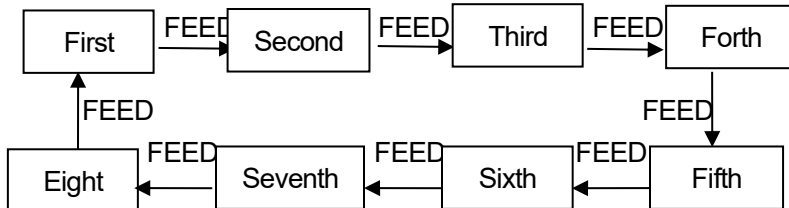

Note :RF AD SET

The setting is as following:



The number with underlined is needed to be changed, press **【FEED】** button to plus one. Press **【MODE】** button, underline moves to the right number. When moving to the last number, press **【MODE】** button, the underline will disappear. Press **【MODE】** button again means entering the next setting .

Manufacture has right to amend the content of the instruction without prior announcement!