

# SPRT®

## SP-RMT11/L21

### Portable Thermal Printer

### User's Manual

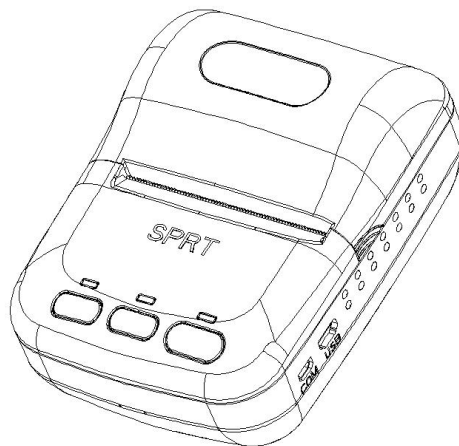

(Ver 1.02)

Beijing Spirit Technology Development Co., Ltd

[www.sprt-printer.com](http://www.sprt-printer.com)

# Content

NOTICE.....	1
Notice of Safety.....	1
Notice of Using.....	1
Notice of Storing.....	1
Chapter 1 Outer Appearance and Model No.....	2
1.1 Outer Appearance.....	2
1.2 Model No.....	2
SP-L21.....	2
Chapter 2 Characteristic Specification.....	3
2.1 Printing Specification.....	3
2.2 Physical Parameters.....	3
2.3 Environment Parameters.....	3
2.4 Other Specification.....	3
Chapter 3 Operation Method.....	4
3.1 Using Preparation.....	4
3.1.2 Paper Roll Installation.....	5
3.1.3 Others.....	5
3.2 Basic function usage.....	5
3.2.1 Switch On.....	5
3.2.2 Switch Off.....	6
3.2.3 Self-test.....	6
3.2.4 Paper Feeding (Manual Feeding).....	6
3.2.5 Battery Charging.....	6
3.3 Printer Setting.....	6
3.4 Printer Interface Connection and Printing.....	7
3.4.1 Serial Port Connection.....	7
3.4.2 USB Connection.....	7
3.4.3 Bluetooth Connection.....	8
3.5 Indicator and Buzzer.....	9
One low one high: power on;.....	9
Chapter 4 Other Information.....	9
4.1 Command Programming Manual.....	9
4.2 Description of Pre-printed Black Mark.....	9
Appendix.....	10

# NOTICE

Please read this manual carefully before using the printer!

## Notice of Safety

Be sure to use the specified battery and power supply provided by our company. Otherwise it may cause fire, explosion or damage printer, meanwhile, the battery also may be damaged.

If the printer would not be used for a long time, be sure to take off the battery, otherwise the battery may leak liquid which is corrosive liquid, if improper operation causes battery leak liquid, and it paste in the skin or clothes, please rinse it by clean water, if paste in the eyes, please rinse them thoroughly by clean water and see a doctor. Please do not open the paper case cover when it is printing or just when printing is finished, do not touch the printer head with hand or body, overheat may cause scald.

## Notice of Using

Don't make the printer print receipt longer than 1m. Otherwise, it might damage the printer.

Water or other liquid should not be spilled into the printer, also the printer should not be appeared in the rain, or else may cause printer damage.

Please do not open the paper case cover when it is printing, otherwise the printer may work improperly.

If printer is using serial port connection to work, should not unplug the serial line, otherwise the data will be incomplete. When printer is using Bluetooth connection to work, the distance of communication should be within 10 meters, otherwise the printer doesn't print or prints rubbish codes.

Though printer can work properly in the 0°C~50°C environment, too high (45°C) or too low (5°C) environment temperature and too high (85%) or too low (20%) environment humidity both effect the printing quality.

The printer paper roll with poor quality or stored for too long time also may reduce the printing quality even damage the printer.

Under the black mark detecting mode, the printer requires that the pre-printed black mark is accordant with the printing rule of black mark (please refer to details in Chapter 4.2), otherwise the black mark can not be detected correctly.

Be sure to use up the power of the battery before charge up it, as it can ensure the using life of the battery. The common working life of printer is:the times of charge/discharge  $\geq$  300, battery performance will decrease with the charge/discharge times developed.

## Notice of Storing

The printer should be placed in such an environment that the temperature is between -20°C and 60°C, and the relative humidity is between 5% and 95%.

If the printer will be stored for a long time, please be sure to take out the battery, otherwise

may damage the battery and printer.

If the printer will be stored for more than three months, battery should be installed and charged on the printer, which in avoid of battery damage of self discharge.

Normal thermal paper receipt can't be kept too long, if you need to keep the receipt for a long period, please choose long-term effective thermal paper.

The thermal paper should be keep away from high temperature environment and point-blank sunshine, please store it where is away from light if it have been open.

# Chapter 1 Outer Appearance and Model No.

## 1.1 Outer Appearance

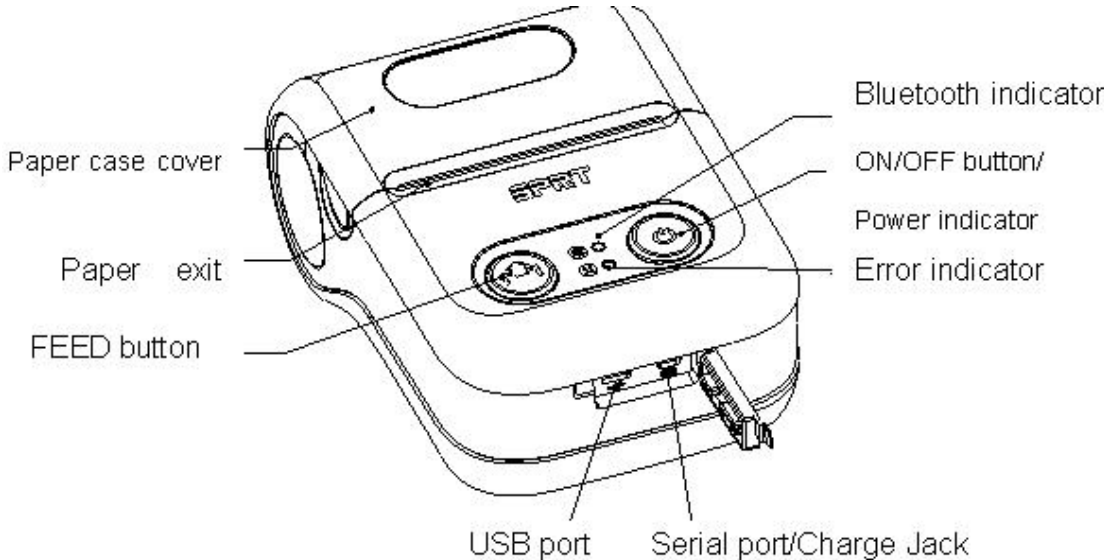

## 1.2 Model No.

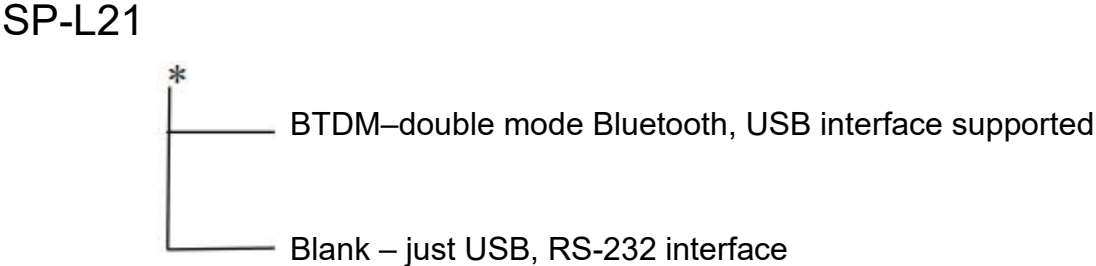
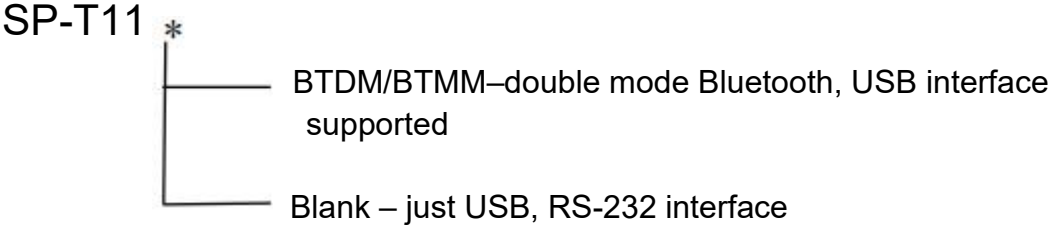

# Chapter 2 Characteristic Specification

## 2.1 Printing Specification

Printing Method: Thermal line

Paper Width: 57.5±0.5mm

Effective Printing Width: 48mm

Resolution: 8dots/mm (203dpi)

Dots per line: 384dots

Printing Speed: max 100m/s for thermal paper

Paper Thickness: 0.06~0.08mm(thermal paper) 0.06~0.15mm(label paper)

Printable Content:GB18030, BIG5,GB12345,Shift+JIS, ASCII,  
custom character set,figure

1DBarcode:UPCA,UPCE,EAN13,EAN8,CODE39,ITF25,CODABAR,  
CODE93,CODE128

2D Barcode:PDF417,QR CODE,DATA Matrix

## 2.2 Physical Parameters

Dimension (W×L×H): 120(L) X82(W) X50.5(H) mm

Physical Weight:300g (excluding roll paper)

Paper Type: Common Thermal Paper/Thermal Label Paper 58 φ 40mm (MAX)

Interface: USB, RS-232, Bluetooth

Printing Head Life: 50km

## 2.3 Environment Parameters

Operating Temp: 0℃~50℃

Operating Humidity: 10%~80%

Storage Temp: -20℃~60℃

Storage Humidity: 10%~90%

## 2.4 Other Specification

- **Paper Loading Method:** drop-in easy loading (please refer to details in 3.1.2 Paper Roll Installation)
- **Tearing way:** manually tearing
- **Black Mark Location:** available(details please see 4.2 pre-printed black mark manual).
  
- **Printing Control Command:** ESC/POS compatible command set  
(refer to<T11/L21Printer Developer Manual >).
- **Power Supply:** 1500mAh rechargeable polymer lithium battery.
- **Low Power Alarm:** When the electric of battery will run out, the power indicator will be red to alarm if there is still printing data in printer. After printing, printer will be in sleeping

mode and buzzer 'one high one low' prompt tone. Or printer will auto power off after buzzer 'one high one low' prompt tone if in the sleeping mode.

- **Auto-sleeping:** the printer will fall into sleep after in 2 seconds without button operation or receiving data , and can be awoken by pressing 【FEED】 button or sending data to it.
- **Battery Charging:** quick charging, it will be fully charged about 2 hours;
- **Battery Duration:** under 25% printing density, more than 90 meters; the standby time is over 15days. (These parameters are just for reference. Long term usage will cause the capacity decline, and can not ensure the time of printing.)

## Chapter 3 Operation Method

### 3.1 Using Preparation

#### 3.1.1 Battery Installation

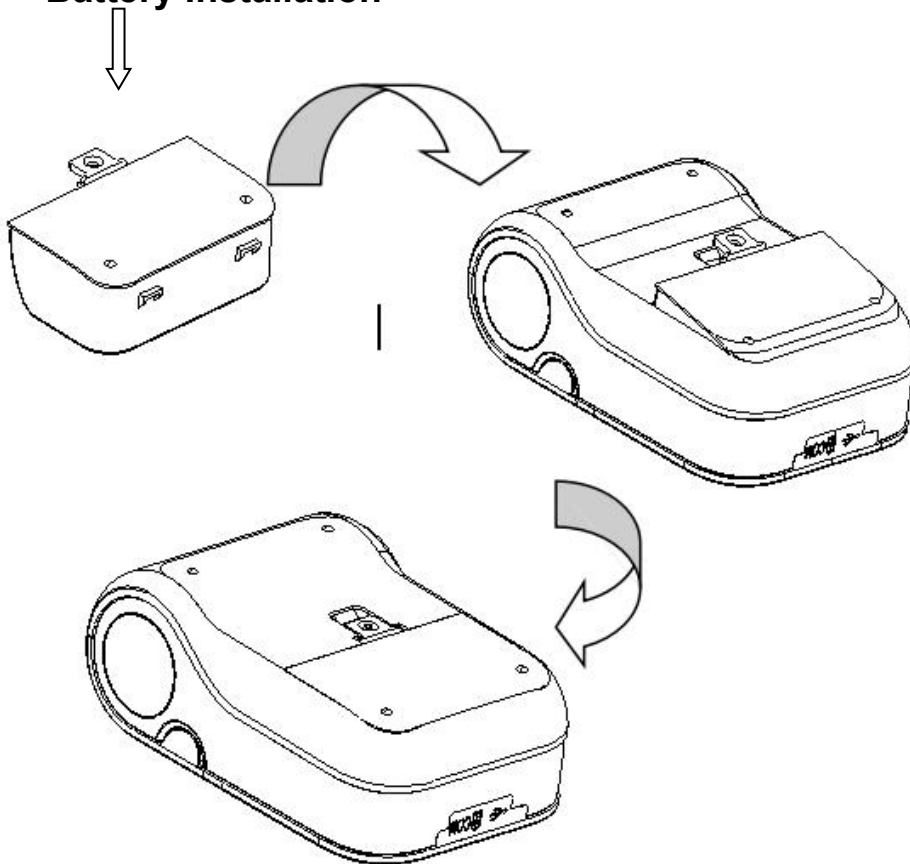

### 3.1.2 Paper Roll Installation

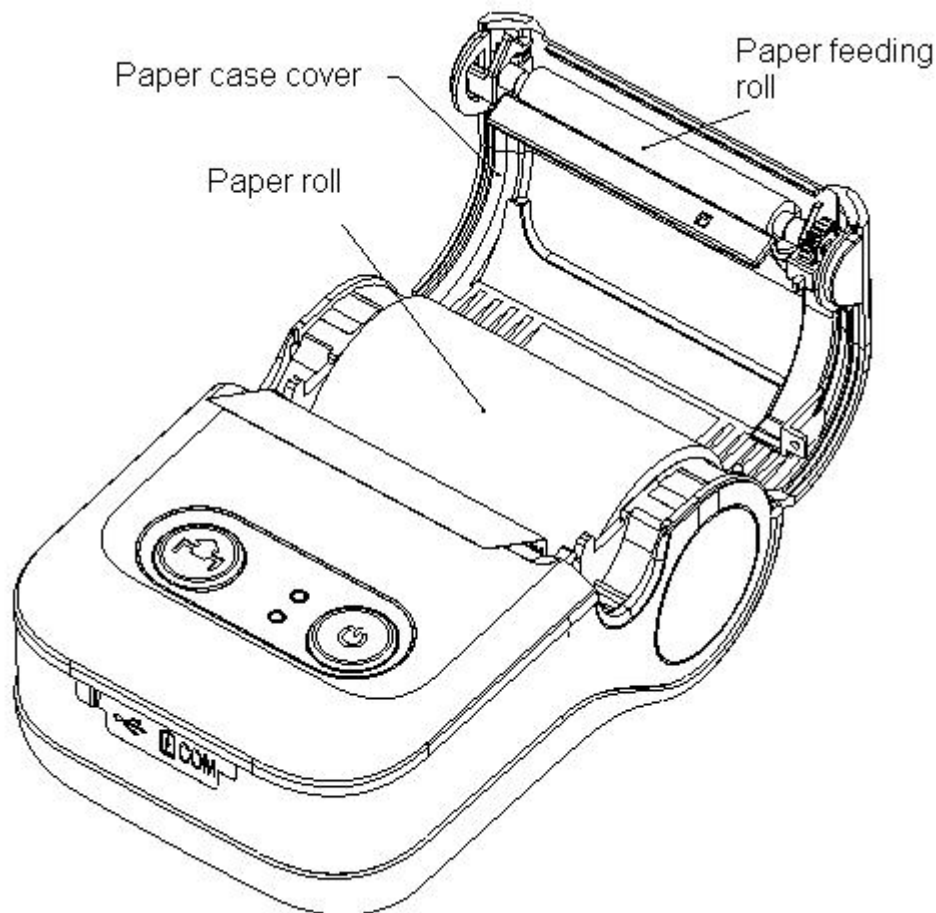

### 3.1.3 Others

Opening and closing instruction: Pls make sure to open or close the paper case at the same time for right and left side

Abnormal operation instructions: The outlet is not allowed to be blocked

Place the direction: When printing, hold it horizontally to ensure the stability of the paper roll.

## 3.2 Basic function usage

T11 support two types paper, thermal paper and black mark paper, use thermal paper by default.

L21 support three types paper, thermal paper, black mark paper and label paper, use label paper by default.

### 3.2.1 Switch On

In the status of power off, press the on/off button for one second, and loose



when hearing the 'one low one high' prompt tone, then the printer will in working status; the power indicator will be green.

Notice: when the battery is almost exhausted, the power indicator will be red, please charge or change the battery if you continue to use the printer. The method of charging the battery, please refer to 3.2.5.

### **3.2.2 Switch Off**

In the status of power on, pressing the on/off button for one second, and loose when hearing the 'one high one low' prompt tone, then the printer off and all the indicators off.

### **3.2.3 Self-test**

After receiving the printer, user can check its current setting and status at anytime. The method of self test is as following: Switch off the printer (if the printer in working mode), holding down the 【FEED】 button, then turn on the power (press the on/off button) at the same time. Then loosen the 【FEED】 button after hearing the power on prompt tone and the current setting and status will be printed out.

### **3.2.4 Paper Feeding (Manual Feeding)**

When the printer works normally, hold down 【FEED】 button, the paper feeding begins, and stops when stopped holding the 【FEED】 button. When the printer works in black mark mode or label mode, hold down 【FEED】 button, the printer begins to feed paper and stops at the position of black mark or gap. If the paper is not black mark paper or label paper, the printer stops automatically after feeding paper for 30cm.

### **3.2.5 Battery Charging**

**The charging method is as following:** connecting the adapter to the power socket, then plug the power charging plug to the power socket of the printer, so the power charging begins. During the power charging, the charging indicator goes red; while goes green when the charging is full. It takes about 2 hours to charge up the battery.

Using the printer during the charging power period will make the charging time go longer.

## **3.3 Printer Setting**

Users can set some simple parameter according to the button operation, there are two methods into set mode, and the setting parameters are different. Users can set more parameters by using the attached software with printer <T11/L21 Setting Tools> through computer. The setting includes:Printer serial Baudrate and data format, black mark, language、 font、 printing density、 Bluetooth device name and password etc. The setting method please refer to the < T11/L21 Setting Tools Software Help>, offered with the software together.

### 3.4 Printer Interface Connection and Printing

#### 3.4.1 Serial Port Connection

The optional configuration of SP-T11/L21 includes one 9 holes/MINUSB 8P(the other end is the MINUSB 8P plug, connected with printer)

The serial port of printer is Uart asynchronous serial Interface, which can work under the Baudrate of 1200bps、2400bps、4800bps、9600bps、19200bps、38400bps 57600bps、115200bps. The method of setting Baudrate refers to 3.3 Printer Setting. The outer appearance and pins are as below picture:

PIN NO	FUNCTION	REMARKS
1, 2	VCC	POWER+
3	CTS	When the signal is 'Mark', it means printer is too busy to receive data, when the signal is 'SPACE', it means printer is ready to receive data
4	RXD	Printer receive data from main engine
5	DSR	When the signal is 'SPACE', it means the status of printer is online
6	TXD	Printer send data for main engine, when use X-ON/X-OFF handshake Protocol, printer send control code X-ON/X-OFF for printer
7, 8	GND	GND, POWER-

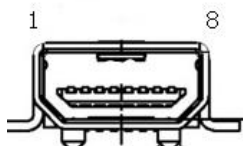

#### 3.4.2 USB Connection

The standard configuration of SP-T11/L21 including a MINI USB cable to connect printer with host device. The printer USB belongs to secondary device

type (DEVICE), the outer appearance and pins are as below picture:

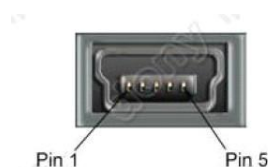

Pin No.	Function	Remark
1	V Bus	Power +5V
2	Data-	Data-
3	Data+	Data+
4		
5	GND	Ground Connection

### 3.4.3 Bluetooth Connection

Hand-held device, laptop and other information terminal devices with Bluetooth can drive T11BTDM/L21BTDM to print by the Bluetooth interface.

T11BTDM/L21BTDM portable printer is compatible with Bluetooth2.0 standard(T11BTDM/L21BTDM is compatible with Bluetooth2.0 regulation and Bluetooth4.0) and power class is CLASS 2, effective communication distance is 10meters. The initial name of the printer is T11 Bluetooth Printer/L21 Bluetooth Printer, the initial password is '1234'. Users can change the printer name and password by using< T11/L21 Setting Tools> software. Please see the details of changing the device name and password in help file of < T11/L21 Setting Tools>.

Before working, T11BTDM/L21BTDM Portable Thermal Printer needs to be paired with host device. Pairing begins with the host device. Usual pairing steps are as below:

1. Switch on printer;
2. Host device searches for the outer Bluetooth device;
3. If there are other Bluetooth devices, please select T11BT Printer/L21BT Printer;
4. Enter the password '1234';
5. Pairing finished.

Please see details in host device Bluetooth function instruction for reference.

#### **Notice:**

If user doesn't change the device name, during pairing, pls do not switch on other printers, otherwise, it will be difficult to identify which printer is paired successfully.

### 3.5 Indicator and Buzzer

There are three indicators - **【POWER】**、**【BULETOOTH】** and **【ERROR】**.  
**【POWER】** indicator is red or green, **【BLUETOOTH】** indicator is blue and **【ERROR】** indicators is red. The below are the meanings of indicators:

#### **【ERROR】 indicator**

**Constant on red lighting:** printer out of paper

**Red light flashing (twice):** it constants on lighting for 5s after flashing twice, , this means over-voltage.

**Red light flashing (once in 500ms):** red light constants 500ms, then turn off 500ms, this means the printing head over-heating.

#### **【BLUETOOTH】 indicator**

**Blue light flashing:** Bluetooth has been connected

**Blue light off:** Bluetooth disconnected

#### **【POWER】 indicator**

**Green light constant on:** printer is power on and in normal status

**Red light constant on:** power of battery is low

There is also a buzzer to indicate various status of the printer. The meanings are as below:

**One low one high:** power on;

**One high one low:** power off or under-voltage seriously, printer switches itself off in the sleeping mode.

**Circulation continuous two highs:** printer at error status

## Chapter 4 Other Information

### 4.1 Command Programming Manual

<T11/L21 printer developing manual> is the technical manual for engineer to develop printer Application. If need, pls contact with our company.

This manual includes the hardware interface (Serial interface, Bluetooth, USB interface) technical description, the technical documentation of printing control command set, and others such as how to print black mark and locate by it.

### 4.2 Description of Pre-printed Black Mark

If users use pre-printed black mark to locate the receipt, please be sure to

abide by the following black mark pre-print regulation when print the black mark paper, otherwise, it will cause that the printer can not identify the black mark.

The black mark pre-print regulations are as below:

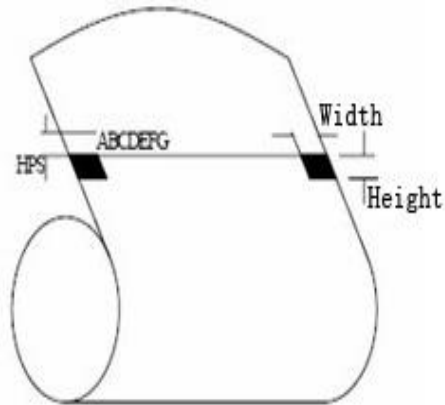

**Printing Position:** As the picture above, the black mark should be printed on the right edge of the printed side of paper.

**Width range:**  $\text{width} \geq 7\text{mm}$

**Height range:**  $4\text{mm} \leq \text{height} \leq 6\text{mm}$

**Reflectivity of infrared ray:**  $< 10\%$  (infrared ray reflectivity of other parts of the black mark paper is  $> 65\%$ )

**HPS:** it is the distance between edges of black mark and loading position.

$4.5\text{mm} \leq \text{Hps} \leq 6.5\text{mm}$

# Appendix

The appendix is usage method to set printer parameters:

**Setting instruction:** Choose setting item through **【MODE】** button. Press **【MODE】** button once, the setting item will go to the next. item and print the current numberable value of this item. Choose the setting value of setting item through **【FEED】** button. Press **【FEED】** button once, the setting value will go to the next.

## T11 Primary settings:

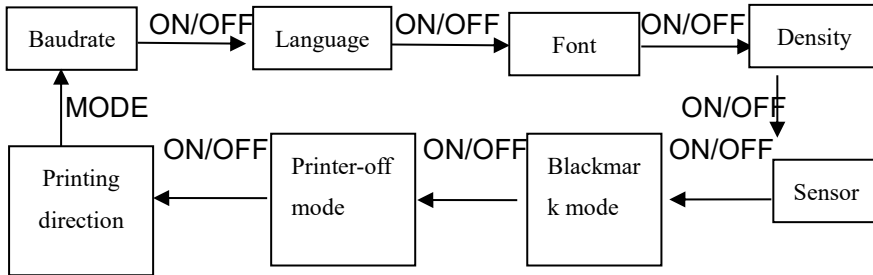

## L21 Primary settings:

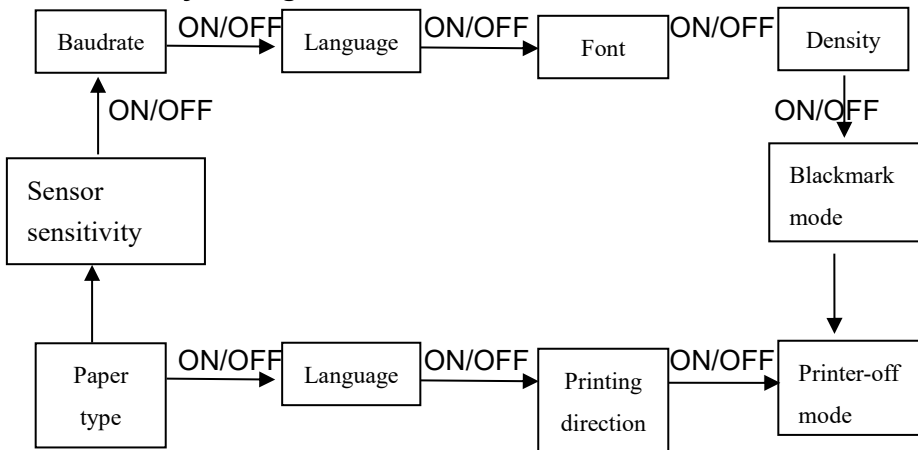

## Baudrate:

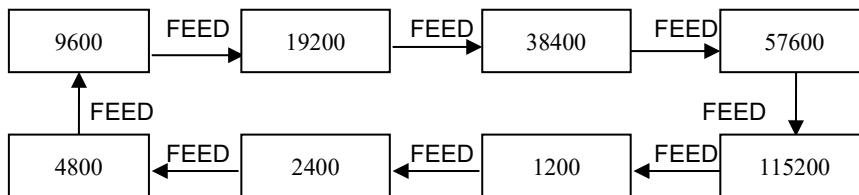

## Language:

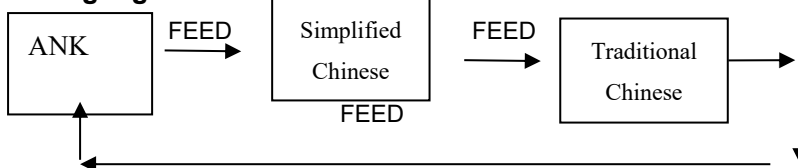

**Font:**

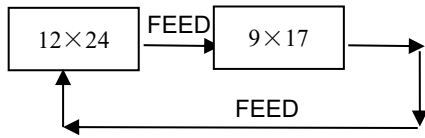

**Density:**

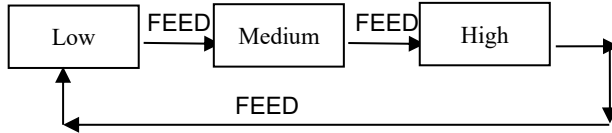

**Sensor sensibility:**

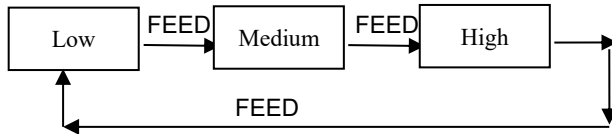

**Black mark mode:**

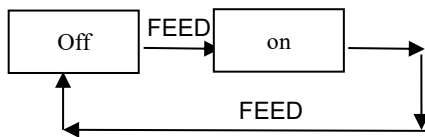

**Black mark position:**

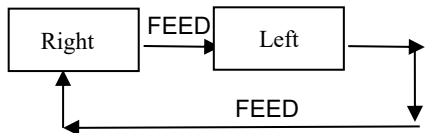

**Manufacture has right to amend the content of the instruction without prior announcement!**