

SPRT®

SP-RMT17

Portable Thermal Printer

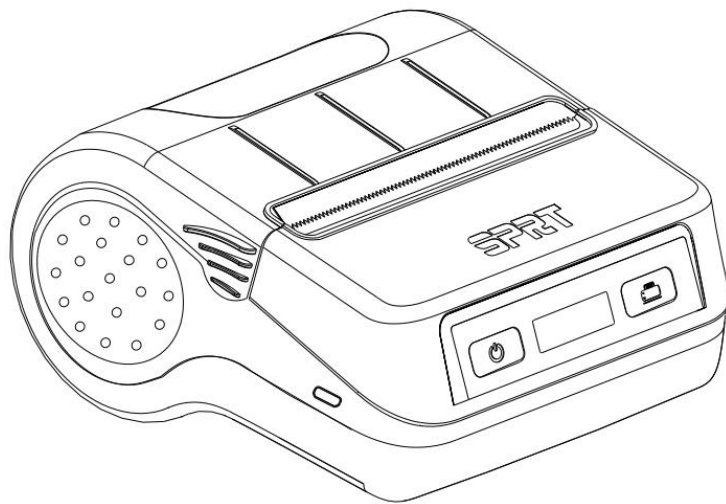

(Ver.1.00)

User's Manual

Beijing Spirit Technology Development Co., Ltd

www.sprt-printer.com

Content

NOTICE.....	1
Chapter 1 Outer Appearance and Model No.....	3
1.1 Outer Appearance.....	3
1.2 Model No.....	3
Chapter 2 Characteristic Specification.....	4
2.1 Printing Specification	4
2.2 Physical Parameters.....	4
2.3 Environment Parameters.....	4
2.4 Other Specification.....	5
Chapter 3 Operation Method.....	6
3.1 Using Preparation.....	6
3.1.1 Battery Installation.....	6
3.1.2 Paper Roll Installation.....	6
3.1.3 Adjustable baffle (change different paper width).....	7
3.1.4 Other.....	8
3.2 Basic function usage.....	8
3.2.1 Switch On.....	8
3.2.2 Switch Off.....	8
3.2.3 Self-Test.....	8
3.2.4 Paper Feeding (Manual Feeding).....	8
3.2.5 Hexadecimal Printing.....	9
3.2.6 Charging.....	9
3.2.7 Enter to upgrade mode.....	9
3.3 Printer Parameter Settings.....	10
3.4 Printer Restore Default Configuration.....	10
3.5 Printer Interface Connection and Printing.....	11
3.5.1 USB Connection.....	11
3.5.2 Bluetooth Connection.....	11
3.6 Buzzer.....	12
3.7 LCD indication.....	12
Chapter 4 Other Information.....	14
4.1 Command Programming Manual.....	14
4.2 Description of Black Mark Pre-print.....	14
Appendix A.....	15

NOTICE

Please read this manual carefully before using the printer.

Notice of Safety

Be sure to use the specified battery and power supply provided by our company. Otherwise it may cause fire, explosion or damage printer, meanwhile, the battery also may be damaged.

Don't put battery into the fire, don't disassemble or heat the battery, don't be short circuit, it may cause fire, explosion or damage printer, meanwhile, the battery also may be damaged.

If the printer would not be used for a long time, be sure to take off the battery, otherwise the battery may leak liquid which is corrosive liquid, if improper operation causes battery leak liquid, and it paste in the skin or clothes, please rinse it by clean water, if paste in the eyes, please rinse them thoroughly by clean water and see a doctor. Please do not open the paper case cover when it is printing or just when printing is finished, do not touch the printer head with hand or body, overheat may cause scald.

Notice of Using

Pls do not print more than 1 meter receipt, otherwise it will cause damage to printer head.

Water or other liquid should not be spilled into the printer, also the printer should not be appeared in the rain, or else may cause printer damage. Please do not open the paper case cover when it is printing, otherwise the printer may work improperly. If printer is using USB connection to work, should not unplug the USB cable, or else some printing data may be lost. When printer is using Bluetooth connection to work, the distance of communication should be within 10 meters, otherwise the printer doesn't print or prints rubbish codes. Too high (50°C) or too low (5°C) environment temperature and too high (85%) or too low (20%) environment humidity both effect the printing quality. The printer paper roll with poor quality or stored for too long time also may reduce the printing quality even damage the printer. Under the black mark detecting mode, the printer requires that the pre-printed black mark is accordant with the printing rule of black mark (please refer to details in Chapter 4.2), otherwise the black mark can not be detected correctly. Be sure to use up the power of the battery before charge up it, as it can ensure the using life of the battery.

Notice of Storing

The printer should be placed in such an environment that the temperature is

between -20°C and 60°C, and the relative humidity is between 10% and 95%. If the printer will be stored for a long time, please be sure to take out the battery, otherwise may damage the battery and printer.

Statement

This is grade A product, which may lead to wireless radio interference. Under this circumstance, may need users to apply practical measures for this interference.

Chapter 1 Outer Appearance and Model No.

1.1 Outer Appearance

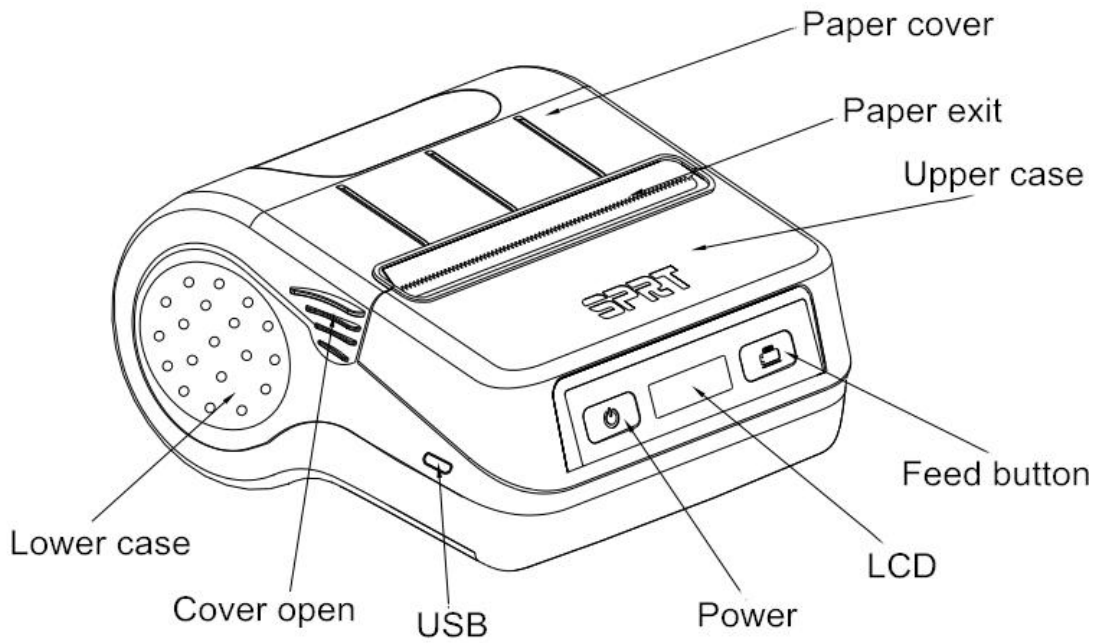

1.2 Model No.

Model	Ports
SP-RMT17	USB
SP-RMT17BTDM	USB and Bluetooth

Chapter 2 Characteristic Specification

2.1 Printing Specification

Printing Method: Thermal line

Paper Width: 79.5mm±0.5mm, 57.5±0.5mm, 44±0.5mm, 30±0.5mm

Effective Printing Width:

Paper Width	Effective Printing Width
80mm	72mm
58mm	48mm
40mm	37.5mm
30mm	27mm

Resolution: 8dots/mm (203dpi)

Dots per line:

Paper Width	Dots per line
80mm	576 dots/line
58mm	384 dots/line
44mm	300 dots/line
30mm	216 dots/line

Printing Speed: Normal thermal paper 80mm/s (Max)

Paper Thickness: 0.06-0.08mm(Normal thermal paper)

Printable Content: GB18030, BIG5, GB12345, ShiftJIS, ASCII, self-defined character set, images.

1D: UPCA, UPCE, EAN13, EAN8, CODE39, ITF25, CODABAR, CODE93, CODE128.

2D: PDF417, QR CODE, DATA Matrix

2.2 Physical Parameters

Dimension (W×L×H): 111(L) X108(W) X60(H) mm

Physical Weight: 320g (excluding roll paper)

Paper Roll Diameter: Max 50.0mm

Interface: USB, Bluetooth

THP: 50KM

2.3 Environment Parameters

Operating Temp: 0°C~50°C
Operating Humidity: 10%~80%
Storage Temp: -20°C~60°C
Storage Humidity: 10%~90%

2.4 Other Specification

Paper Loading Method: drop-in easy loading (please refer to details in 3.1.2 Paper Roll Installation)

Paper cutting method: Manual

Black Mark Location: available (details please see 4.2 pre-printed black mark manual).

Printing Control Command: ESC/POS compatible command set
(refer to <SP-RMT17 Printer Developer Manual >).

Power Supply: 7.4V 1400mAh rechargeable polymer lithium battery.

Low Power Alarm: When the electric of battery will run out, the battery icon in the LCD flashes.

Battery Charging: quick charging, it will be fully charged about 3 hours;

Auto-sleeping: the printer will fall into sleep after 5 seconds without button operation or receiving data, and can be awoken by pressing **【FEED】** , **【Power】** button, opening paper cover or sending data to it.

Battery Duration: under 25% printing density, more than 200 meters; the standby time is over 2 days. (These parameters are just for reference. Long term usage will cause the capacity decline, and can not ensure the time of printing.)

Chapter 3 Operation Method

3.1 Using Preparation

3.1.1 Battery Installation

Put the battery into the battery slot from the side with pins and press the other side into case. (as below Fig.)

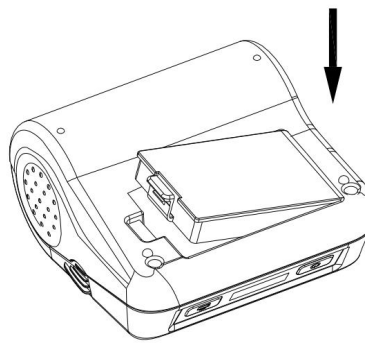

3.1.2 Paper Roll Installation

1. Hold both sides of the paper case cover, and open it. (Figure 1 and 2), Keep your hands dry in case of slipping.

2. Loading paper, thermal side down. Pull out a part of paper (End of the paper exceed the paper tearing bar) (Figure 3).

3. Close paper case and cut off the redundant paper.

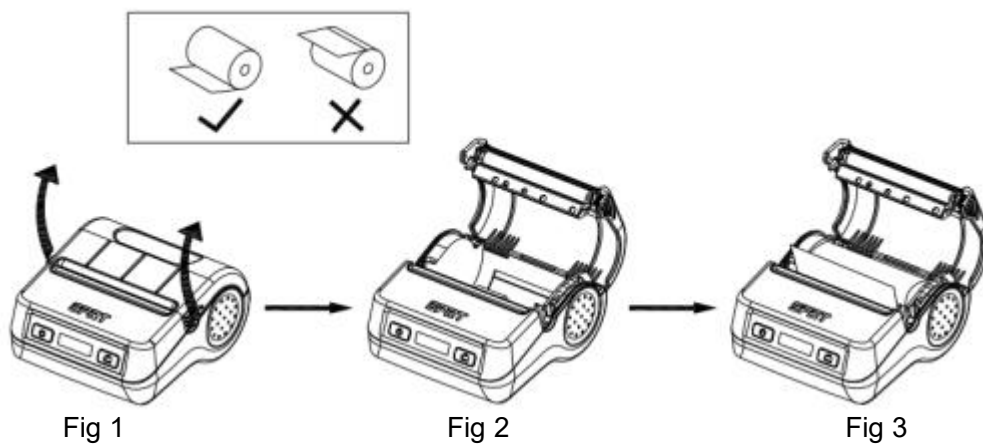

3.1.3 Adjustable baffle (change different paper width)

① Unlock key ② Lock the slider ③ Drag hole (Figure 4)

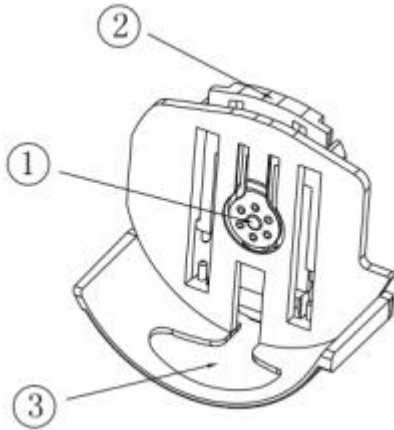

Fig 4

- ◆ Press the unlock button ①, the lock slider bounces to unlock;
- ◆ Drag buttonhole ③ with your finger to adjust the baffle to the proper position according to the paper width;
- ◆ Press the lock slider ② to lock the baffle. (shown in Figure 5).



Fig 5

3.1.4 Other

Switch door description: Keep left and right synchronized when opening or closing the paper compartment cover.

Abnormal operation instructions: Paper jam is not allowed at the paper exit.

Placement direction: It is recommended to print flat or flat when printing.

3.2 Basic function usage

Support two Paper Types: Thermal paper, Black mark paper.

Paper width supported: 80mm、 58mm、 44mm and 30mm.

Paper type and paper width can be set by setting tool.

3.2.1 Switch On

Press **【POWER】** button, you will hear 'one low one high 'prompt tone. The LCD shows "Loading...", then the printer turns into work mode when loosen the **【POWER】** button. The LCD shows printer parameter.

3.2.2 Switch Off

Under status of switch on, the printer will send out the prompt tone of 'one low one high' after pressed the **【POWER】** button, the LCD turns off, then loosen the **【POWER】** button, the printer is off.

3.2.3 Self-Test

After receiving the printer, user can check its current setting and status at anytime. Self-test way is as below: Power off, then hold down the **【FEED】** button and press the **【POWER】** button at the same time. Then loosen the **【FEED】** button when you hear 'one low one high 'prompt tone and LCD shows "Loading...", the current setting and status will be printed out.

3.2.4 Paper Feeding (Manual Feeding)

In the power on status, normal thermal paper, press the **【FEED】** button, the

printer starts to feed the paper, release the **【FEED】** button to stop the paper feed;

For the black mark paper, press the **【FEED】** button to start the printer. Take the paper to the black mark and stop the paper. If it is not the black mark paper, the paper will automatically stop feeding after 30cm.

3.2.5 Hexadecimal Printing

The function of hexadecimal printing is to print the information received from host machine by hexadecimal numbers and corresponding characters. It will be convenient to debug application.

Into hexadecimal printing: Power off, open paper cover, press the **【FEED】** button and **【POWER】** at the same time. When you hear 'one low one high' prompt tone of power on and LCD shows "Loading...", loosen the **【POWER】** button, then the **【FEED】** button. The printer turns into the hexadecimal printing mode and print the presentation. Close the paper cover.

Exit hexadecimal printing :The way to exit hexadecimal printing mode is switch off the printer or press the **【FEED】** button for three times. The printer will also print the presentation which shows that the printer have exit hexadecimal printing mode.

3.2.6 Charging

After the printer has been in use for a while, the printer's battery power is consumed. When the printer's battery is almost exhausted, the battery indicator on the LCD will flash an alarm, and the user needs to charge the battery.

The charging method is as follows: Insert the mains plug of the power adapter into the 220V, 50HZ power socket, and then plug the charging plug into the printer's power socket, the printer will start charging. During the charging process, the printer's LCD screen will be charged.

In the off state: the icon has a plug, the battery's battery continues to jump to indicate that it is charging; only one battery icon indicates that it is full.

In the power-on state: the battery icon in the upper right corner continuously flashes to indicate that it is charging; the battery does not move, indicating that it is full.

Do not use the printer during charging.

3.2.7 Enter to upgrade mode

a. Quick access method:

In the off state, open the **【Paper Cover】** and hold down the **【FEED】** button,

press and hold the **【Power】** button. When you hear a short beep, quickly release the **【FEED】** button and the printer enters the program upgrade mode. At this time, the LCD displays the upgrade mode. Upgrade with the "UpdateFirmware" (PC side upgrade tool) upgrade tool.

Note: Only the USB interface supports this mode of upgrade.

b. Upgrade in printing mode:

In the power-on state, the printer can support the print mode upgrade when there is no error. You can connect to USB and use the "UpdateFirmware" upgrade tool to connect to the USB upgrade. You can also use the "SprtPrinterUpdateTools" (mobile side upgrade tool) upgrade tool to connect to Bluetooth for upgrade.

3.3 Printer Parameter Settings

Printer parameter setting method: setting tool and button operation.

The printer uses the setting tool software to make parameter set from the computer. You can set the printer's language, font, default code page, printer's Bluetooth device name and password, print mode, and more. For details on how to set it up, see the <Setup Tool Software Help> file, which is provided with the software.

Some simple parameters of the printer can be set by pressing the button, as follows.

In the off state, first open the **【Paper Cover】**, press and hold the **【Power】** button, and hear it open.

When the machine prompts and the LCD is activated, first release the **【Power】** button and then press the **【FEED】** button twice to print into the parameter setting mode. Close the **【Paper Cover】** or press the **【FEED】** button. The LCD displays the first settable parameter and its current setting. See Appendix A for detailed setup methods.

To exit the parameter setting: first open the **【Paper Cover】**, then press the **【FEED】** button, then close the **【Paper Cover】** and release the **【FEED】** button to save the set parameter and exit the parameter setting mode. If you press and hold the **【Power】** button to turn off the printer, the set parameter values will not be saved.

3.4 Printer Restore Default Configuration

Use this function to restore the factory configuration contents when the printer configuration item is incorrectly configured and does not work properly.

In the off state, first open the **【Paper Cover】**, press and hold the **【FEED】**

button, then press and hold the **【Power】** button. When you hear the startup tone and the LCD screen starts, release the **【Power】** button, then release **【 FEED】** key. Press the **【FEED】** button three times, then close the **【Paper Cover】** . The printer enters the factory reset mode. And print out the "Note: set the recovery system to the default value, press the FEED button once to confirm. Direct power off cancel" prompt words.

Direct power off cancels recovery.

After pressing the paper feed button, the printer will print out the words "Resume system setup successfully". After the recovery is complete, the printer will automatically shut down.

3.5 Printer Interface Connection and Printing

3.5.1 USB Connection

The printer of standard accessories includes Micro USB cable which connects printer and main device. The USB type belongs to the slave device type. Pins description of Mini-USB as below:

Pin	Function	Notes
1	V Bus	Power +5V
2	D-	Data-
3	D+	Data+
4	ID	Blank
5	GND	Ground



Micro -USB socket and Pins description

3.5.2 Bluetooth Connection

The devices, such as Hand-held device, laptop and other information terminal devices with Bluetooth can drive SP-RMT17 to print by the Bluetooth interface. SP-RMT17 portable printer is compatible with Bluetooth2.0 standard and dual Bluetooth(IOS Bluetooth 4.0 and Android Bluetooth 2.0) . Power class is CLASS 2, effective communication distance is 10meters. The Bluetooth of the printer belongs to the slave device. The initial name of the printer is SP-RMT17 BT Printer, the initial password is '1234'; users can change the printer name

and password by using <Setting Tools> software. Please see the details in file of <Setting Tool User Guide>.

Before working, SP-RMT17 Portable Thermal Printer need to be pairing with primary device, matching begins with the host device. Usual matching course is as below:

1. Switch on printer;
2. Host device searches for the outer Bluetooth device;
3. If there are other Bluetooth devices, please select SP-RMT17BT Printer;
4. Enter the password '1234';
5. Pairing finished.

Please see details in primary device Bluetooth function instruction for reference.

Notice:

1. When pairing, please make SP-RMT17 printer switch on.
2. Once the Bluetooth has paired with the host successful, it can't be paired with other Bluetooth device until it unconnected with the host.
3. The power indicator flashing after paired successful. Printer LCD shows the connection state.



3.6 Buzzer

There is also a buzzer to indicate various status of the printer. The buzzer prompts three states through different tones: power on, power off, and error. Different tones can be configured through <Setting Tools> software. The sound effect is subject to the machine.

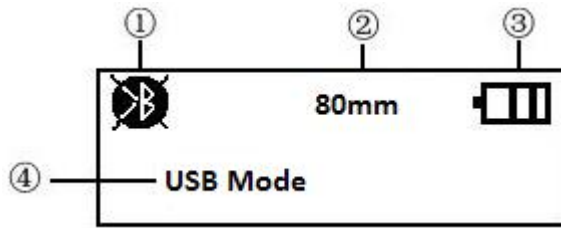

3.7 LCD indication

Turn on the printer, the LCD shows "Loading...", and shows the relevant information after printer initialization. If printer didn't receive any data or connect with any device within 5 min., the display will turn off showing automatically. But it'll show again until printer receive data or connect with device.



① When the icon is , it means there's no Bluetooth connection; When the icon is , it means the Bluetooth is on connecting state.

② It shows the different paper type, 80mm, 58mm and 44mm and 30mm.

③ The current capacity level of printer battery icon. The different icons  shows the current battery level. When it comes to low battery level and need to charge, it'll become to show this icon  with flickering

④ Printer current state is showed by text.

It shows USB connected when the printer connect with main device via USB.

It shows USB communicating when the printer received data via USB connection.

It shows Bluetooth connected when the printer connect with main device via Bluetooth and open the corresponding port.

It shows USB and Bluetooth connected when the printer connect with main device via both Bluetooth and USB.

It shows Bluetooth communicating when the printer received data via Bluetooth connection.

Chapter 4 Other Information

4.1 Command Programming Manual

<SP-RMT17 Commands Manual> is a technical manual for engineer to develop printer utility, and users can claim our company for it.

4.2 Description of Black Mark Pre-print

If user use pre-print black mark to locate the receipt, please be sure to abide by the following black mark pre-print regulation when print the black mark paper, if not ,it will cause that the printer can not identify the black mark.

The black mark pre-print regulations are as below:

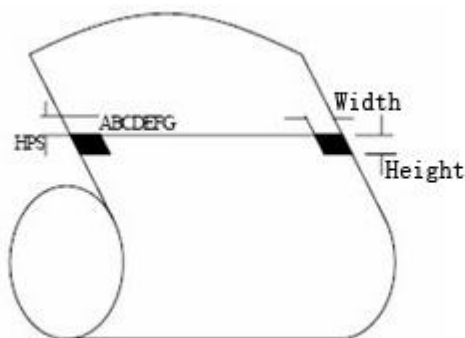

Printing Position: As the Figure above, the black mark should be printed on the right or left edge of the side of words.

Width range: $\text{width} \geq 7\text{mm}$

Height range: $4\text{mm} \leq \text{height} \leq 6\text{mm}$

Reflectivity of infrared ray: $< 10\%$ (infrared ray reflectivity of other parts of the black mark paper is $> 65\%$)

HPS: it is the distance between edges of black mark and loading position.

$4.5\text{mm} \leq \text{HPS} \leq 6.5\text{mm}$

Appendix A

Setting introduction: Open and close the paper cover to choose the setting. The setting moves to the next and shows on the LCD if the paper cover open and close once. 【FEED】 button used to choose the set value. When press it once , the setting moves to the next.

After setting, press 【FEED】 button and open the paper cover to save the set value. And printer enters into normal operation state. Otherwise the set value won't saved.

General Setting:

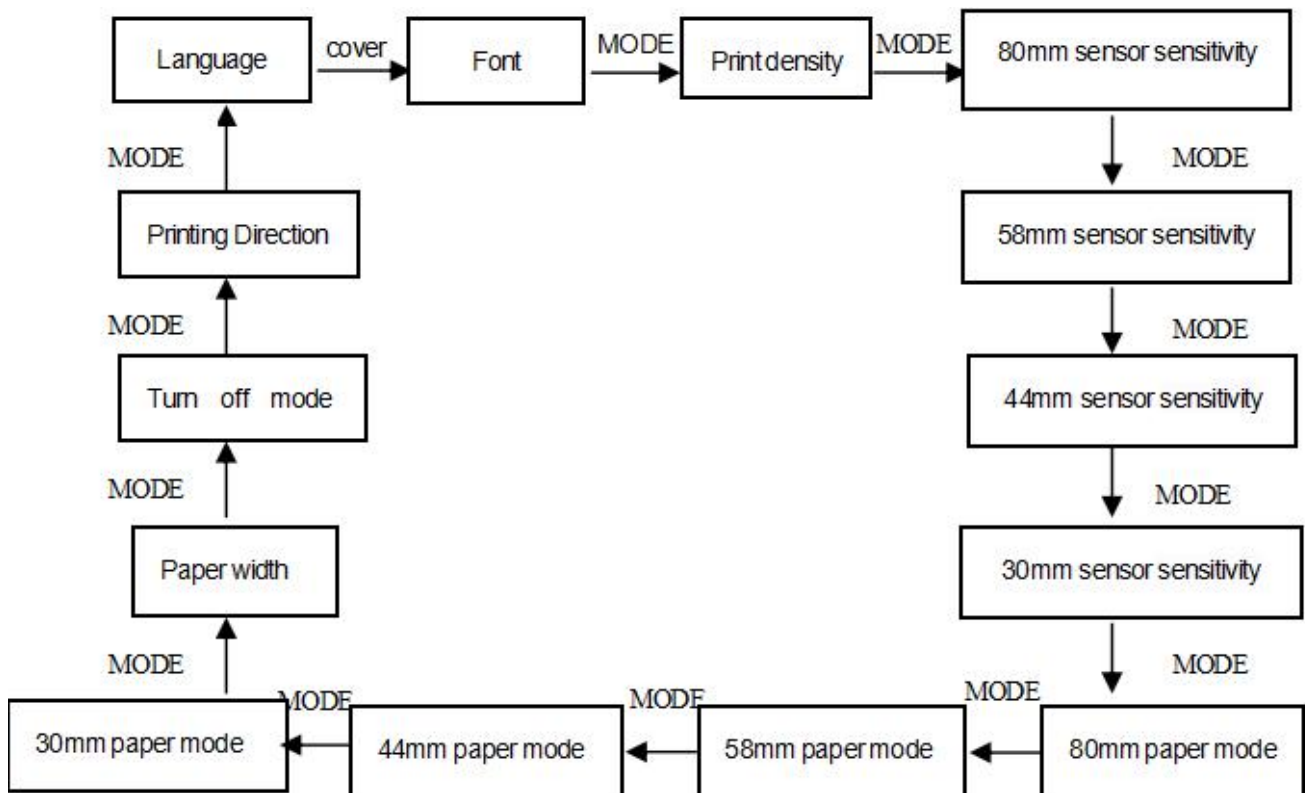

Language Setting:

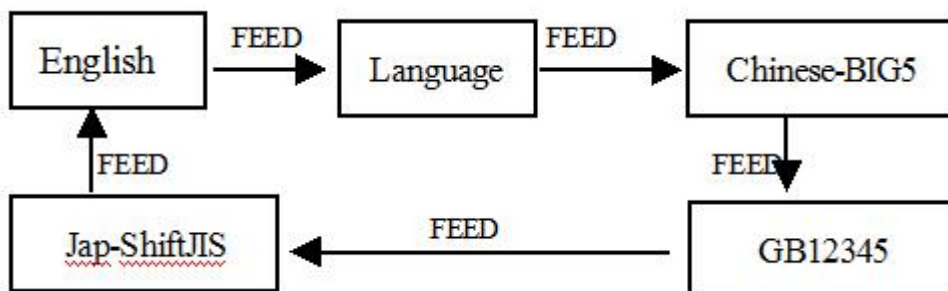

Font:

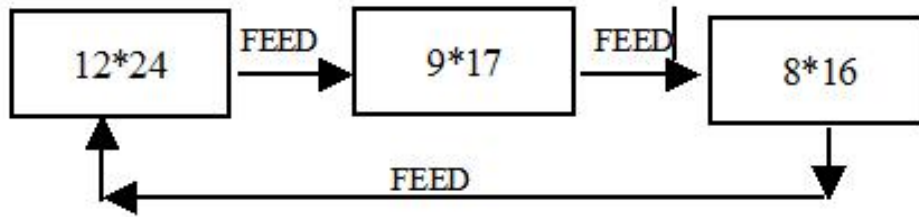

Print density:

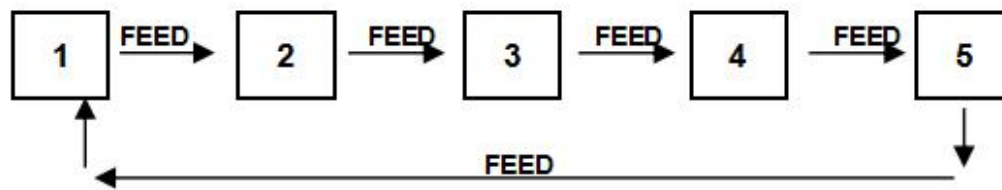

Paper sensor sensitivity Setting:

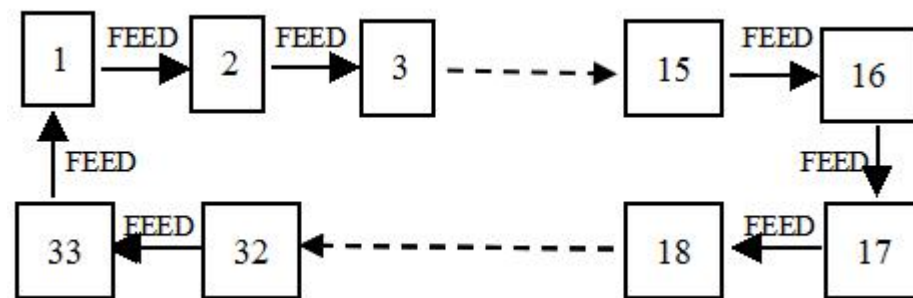

80mm/58mm/44mm/30mm Paper Type Setting:

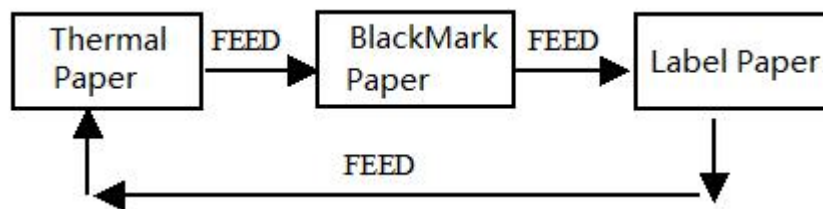

Paper width setting:



Power off Setting:

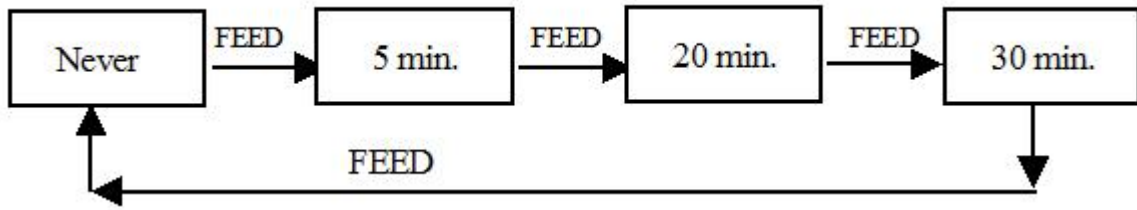

Printing Direction Setting:

