

# SP-L39 Portable Label Printer

## User's Manual

(VER 1.00)

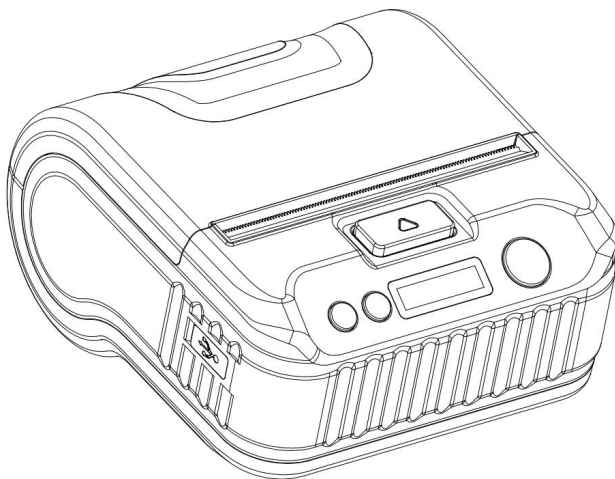

[www.sprinter.com.cn](http://www.sprinter.com.cn)

## Content

Precautions.....	4
Safety Precautions.....	4
Precautions for use.....	5
Storage Precautions.....	6
Chapter 1 Printer Appearance and Model.....	7
1.1 Appearance.....	7
1.2 Model.....	8
Chapter 2 Performance Characteristics.....	8
2.1 Printing performance.....	8
2.2 Physical parameters.....	9
2.3 Environmental parameters.....	10
2.4 Other properties.....	10
Chapter 3 How to use.....	12
3.1 Preparation before use.....	12
3.1.1 Battery installation and removal.....	12
3.1.2 Printing paper roll installation.....	12
3.1.3 Cleaning and maintenance.....	13
3.1.4 Others.....	15
3.2 Use of basic functions.....	15
3.2.1 Power on.....	16
3.2.2 Shutdown.....	16
3.2.3 Self-test.....	16
3.2.4 Paper feeding (manual feeding).....	17
3.2.5 Hexadecimal Printing.....	17

3.2.6 Printer parameter settings.....	18
3.2.7 Charging.....	20
3.2.8 Enter program upgrade mode.....	21
3.3 Printer parameter settings.....	22
3.4 Printer Label Sensor Calibration.....	22
3.5 Restore the printer to default .....	24
3.6 Printer connection and printing.....	25
3.6.1 USB connection.....	25
3.6.2 Bluetooth connection.....	25
3.6.3 wifi connection.....	27
3.7 Buzzer description.....	28
3.8 Description of LCD display.....	28
Chapter 4 Other Information.....	32
4.1 Command Programming Manual.....	32
4.2 Instruction on Label Paper.....	32
Appendix A.....	33
Appendix B.....	36

## **Precautions**

Please read this chapter carefully before using the printer!

## **Safety Precautions**

This printer can only use the special battery and power adapter provided by the company, otherwise it may cause product damage, battery leakage, fire or even explosion.

Do not throw the battery into fire, do not short-circuit, disassemble or heat the battery, otherwise it may cause the battery to leak, catch fire or even explode.

If the printer will not be used for a long time, be sure to remove the battery from the printer, otherwise the battery may leak.

The liquid in the battery is corrosive. If the battery leaks and the liquid sticks to the skin or clothing due to careless operation, please wash it off with clean water immediately. See a doctor.

Do not open the paper compartment cover during printing or just after printing, and touch the printing core with your hands or any

part of your body to avoid burns caused by excessive temperature.

**Notice**  
**Danger of explosion if battery is replaced  
with wrong type**

## Precautions for use

The printer should not be immersed in water or exposed to rain, as this may cause damage to the printer.

Do not open the paper compartment cover during printing, otherwise the printer may not work properly.

When using the USB interface to print, do not unplug the USB cable during the printing process, otherwise the print data may be incomplete. When using Bluetooth to print, the distance should not exceed 10 meters during the printing process, otherwise it may cause garbled characters to be printed or unable to print.

Although the printer can work stably from  $-10^{\circ}\text{C}$  to  $50^{\circ}\text{C}$ , too high ambient temperature ( $45^{\circ}\text{C}$ ) or too low ambient temperature ( $5^{\circ}\text{C}$ )

will result in reduced print quality.

Too high ambient humidity (above 85% relative humidity) or too low ambient humidity (below 20% relative humidity) can result in poor print quality.

Using poor-quality paper or paper that has been stored for an extended period of time may result in poor print quality and even damage to the printer.

When the printer works in the label detection mode, the label is required to meet the specifications (see 4.2 Label Paper Instructions), otherwise the printer may not be able to accurately detect the label.

## **Storage Precautions**

The printer should be stored in an environment with a temperature of -20°C to 60°C and a relative humidity of 10% to 90%.

If you store the printer for a long time, be sure to remove the battery from the printer and store it separately, otherwise it may cause the battery to fail or even leak, which may damage the

printer.

### Statement

This is a Class A product, which may cause radio interference in a living environment. In this case, the user may be required to take practical measures for the interference.

## Chapter 1 Printer Appearance and Model

### 1.1 Appearance

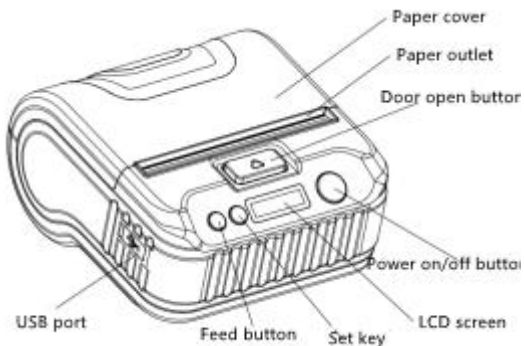

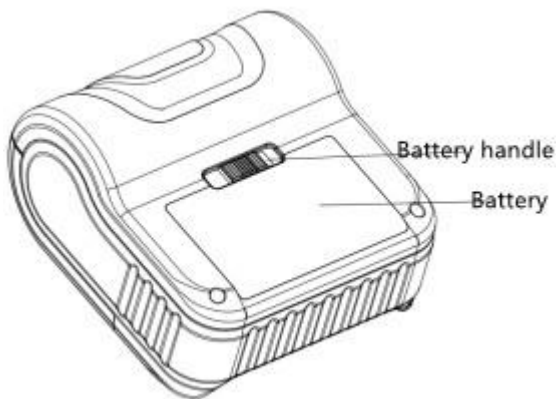

## 1.2 Model

Model	Interface
SP-L39BTDM	USB、Bluetooth
SP-L39W	USB、WiFi

## Chapter 2 Performance Characteristics

### 2.1 Printing performance

Printing method: line thermal printing;

Printing paper width: 40-80mm



Effective printing width: 72mm;

Resolution: 8 points/mm (203dpi);

Points per line: 80mm: 576 points/line;

Printing speed: Normal paper: 80mm/s(Max); Label paper: 80mm/s(Max);

Paper thickness: 0.06-0.08mm (normal thermal paper), 0.06-0.15mm (label paper);

Printable content: GB18030 all Chinese characters and characters, BIG5 all traditional Chinese characters, GB12345 all traditional Chinese characters, ShiftJIS Japanese Chinese characters, ASCII characters, custom characters, graphics, Siyuan vector fonts.

1D barcode: UPCA, UPCE, EAN13, EAN8, CODE39, ITF25, CODABAR, CODE93, CODE128.

2D barcode: PDF417, QR CODE, DATA Matrix

## **2.2 Physical parameters**

Appearance size: 113(L)X105(W)X60(H)mm;

Weight: 375g (without paper roll);

Paper roll diameter: ≤50mm;

Interface: USB, Bluetooth, WiFi

## **2.3 Environmental parameters**

Working environment temperature: -10°C ~ 50°C;

Working environment humidity: 10% ~ 90% (relative humidity);

Storage environment temperature: -20°C ~ 60°C;

Storage environment humidity: 10% to 90% (relative humidity)

## **2.4 Other properties**

Paper loading method: simple paper loading (please refer to 3.1.2 Printing Paper Roll Installation for the paper loading method).

Tear-off method: Manually tear the paper, the paper head is aligned with the tear-off cutter, supporting zero waste for the first order.

Print control instructions: ESC/POS compatible instruction set/CPCL compatible instruction set/TSPL compatible instruction

set (see "SP-L39 Instruction Programming Manual" for details).

Power supply mode: 7.4V/2000mAh rechargeable polymer lithium battery.

Battery Alarm: When the battery is about to run out, the battery icon on the printer's LCD screen flashes.

Charging: Fast charging, it can be fully charged within 4 hours.

Auto Sleep: If the printer does not receive print data or key operation within 5 seconds. The printer will automatically sleep.

During the sleep period, if you press the [FEED] button, the [MODE] button, the power button, or the printer receives print data, it will wake up automatically;

Available time on a single charge: more than 200m at 25% printing density, and standby time more than 4 days. This parameter is a reference parameter. After the battery is used for a long time, the capacity may decrease and the printing time cannot be guaranteed.

## Chapter 3 How to use

### 3.1 Preparation before use

#### 3.1.1 Battery installation and removal

1. Put the end of the battery into the slot on the back of the main body first (as shown in the figure below).
2. Press down the front of the battery again until the buckle is in place with the main body.
3. When disassembling, turn the battery wrench to the right to remove the battery.



#### 3.1.2 Printing paper roll installation

1. Open the paper compartment cover (as shown in Figure 1), slide the paper roll baffle to the outside, and place your fingers in

the finger grooves when sliding the baffle (as shown in Figure 2).

2. Load the roll paper with the thermal side facing down, and pull out the paper in the paper compartment (the end of the paper is beyond the tear-off sheet) (as shown in Figure 3).

3. Close the paper compartment cover and tear off the excess paper.

4. When using label paper larger than 76mm, you need to remove the paper width baffle (as shown in Figure 2).

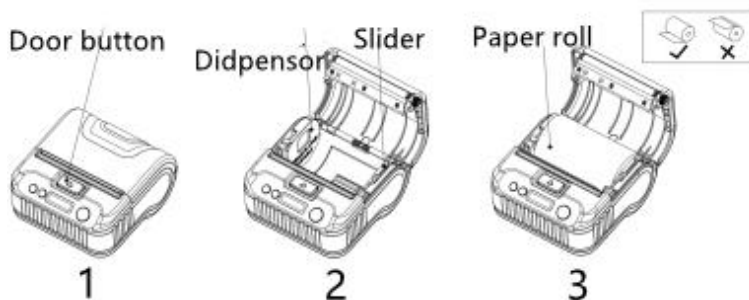

### 3.1.3 Cleaning and maintenance

The thermal movement requires regular maintenance, as follows:

1. As shown in the figure below, use a dust brush to clean the

paper scraps and dust on the paper feeding roller of the machine core.

2. As shown in the figure below, use a cotton swab to dip an appropriate amount of alcohol, wipe the heating plate of the core, and remove impurities such as carbon deposits, dust and paper scraps.

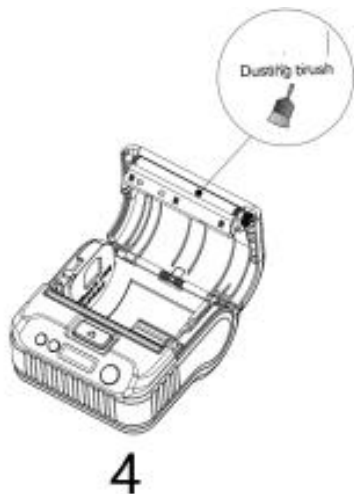

### 3.1.4 Others

Instructions for opening and closing the door: After pressing the door opening button, the cover of the paper compartment pops up.

Instructions for abnormal operation: No paper jam is allowed at the paper outlet.

Placement direction: When printing, hand-held flat printing, try to ensure the stability of the paper roll.

## 3.2 Use of basic functions

Two printing modes: ticket mode and label mode.

Two paper types: plain paper and label paper.

Label mode is divided into: 80mm, 58mm, 40mm; in label mode, the paper type is label paper.

The bill mode is divided into: 80mm, 58mm; in the bill mode, the paper type is plain paper.

The print mode and paper width are set with the setting tool.

Vector fonts are supported in label mode.

### **3.2.1 Power on**

Press and hold the [Power] key, you will hear the prompt tone of "one low and one high", and the LCD screen displays "Loading...", then release the [Power] key, the printer enters the working mode, and the working parameters of the printer are displayed on the LCD screen .

### **3.2.2 Shutdown**

In the power-on state, press and hold the [Power] key, the printer emits a "one high and one low" prompt tone, the LCD screen turns off, and then release the [Power] key to turn off the printer.

### **3.2.3 Self-test**

After the user gets the printer, he can perform self-test on the printer at any time to detect the current settings and status of the printer.



Entering self-test: In the power-off state, press and hold the [FEED] key, press and hold the [Power] key, and when you hear the "one low, one high" power-on prompt and the LCD screen displays "Loading...", release the [Power] key and then release the [FEED] key, the printer's self-test test page will be printed out.

### 3.2.4 Paper feeding (manual feeding)

#### a. Ticket Mode

In the power-on state of plain paper, press the **【FEED】** key, the printer starts to feed paper, and release the **【FEED】** key to stop feeding;

#### b. Label mode

When the label mode is turned on, press the **【FEED】** button, the printer starts to feed the paper to the gap and stops feeding. If it is not the label paper, it will automatically stop feeding after 26cm length paper, and report out of paper error.

### 3.2.5 Hexadecimal Printing

The hexadecimal printing function is to print the data received

from the host with hexadecimal numbers and its corresponding characters, which is convenient for debugging the application.

Enter hexadecimal printing: in the power-off state, press and hold the **【MODE】** key, then press and hold the [Power] key, when you hear the "one low, one high" power-on beeping and the LCD displays "Loading...", Release the [Power] key, then press the **【FEED】** key, then release the **【MODE】** key and the **【FEED】** key, the printer enters the hexadecimal printing mode, the LCD displays the hexadecimal mode, and the corresponding information is printed out.

Exit hexadecimal printing: Turn off the power or press the **【FEED】** key three times to exit the hexadecimal printing mode, enter the normal working mode, and print out the prompt information for exiting the hexadecimal mode.

### 3.2.6 Printer parameter settings

Some simple parameters of the printer can also be set by key operation. There are two ways to enter the printer parameter

setting mode, and the parameter setting content is different.

a. In the power-off state, press and hold the **【MODE】** key first, then press and hold the **【POWER】** key, and when you hear the "one low, one high" power-on prompt and the LCD screen displays "Loading...", release the **【Power】** key first. And then release the **【MODE】** key, the printer will enter the parameter setting mode. Press **【MODE】** or **【FEED】** key, the LCD screen displays the first settable parameter and its current set value. Please refer to Appendix A for the detailed setting method.

Exit parameter setting: first press and hold the **【MODE】** key, then press and hold the **【FEED】** key, then release the **【MODE】** key and **【FEED】** key, save the set parameter value and exit the parameter setting mode; enter the normal working mode. If you directly press and hold the **【POWER】** key to turn off the printer, the set parameter values will not be saved.

b. In standby mode, press **【MODE】** key for more than two seconds to enter parameter setting mode; **【MODE】** & **【FEED】** key in combination, press **【MODE】** key to adjust setting parameter

options, press 【 FEED 】 key to adjust the submenu of each parameter setting item; please refer to Appendix B for detailed setting method. After the setting is completed, wait for 5 seconds, automatically exit the setting mode, save the setting parameters.

### **3.2.7 Charging**

After the printer is used for a period of time, the power of the printer battery will be exhausted. When the battery power of the printer is nearly exhausted, the battery power indicator icon on the LCD screen will flash to give an alarm, and the user needs to charge the battery at this time.

The charging method is as follows: insert the mains plug of the power adapter into the 220V, 50HZ power socket, and then insert the charging plug into the power socket of the printer, and the printer will start charging. During the charging process, the LCD screen of the printer will have a charging prompt.

In the off state: the icon has a plug, and the battery's power keeps beating to indicate that it is charging; only a battery icon is

displayed to indicate that it is fully charged.

In the power-on state: the battery icon in the upper right corner keeps beating to indicate that it is charging; the battery does not move, indicating that it is fully charged.

### 3.2.8 Enter program upgrade mode

a. Quick access method:

In the off state, press and hold the **【MODE】**key and the **【FEED】** key at the same time, press and hold the [Power] key to turn on, quickly release the **【FEED】** key within 200 milliseconds, and then release other keys, the printer enters the program upgrade mode. At this time, the LCD screen displays "Upgrading...". Use the "UpdateFirmware" (PC-side upgrade tool) upgrade tool to upgrade.

Note: Only the USB interface supports this upgrade way.

b. Upgrade in print mode:

In the power-on state, the printer can support printing mode upgrade when there is no error state. You can connect USB and

use "UpdateFirmware" upgrade tool to upgrade. You can also use the "SprtPrinterUpdateTools" (mobile phone upgrade tool) upgrade tool, connect Bluetooth or WiFi to upgrade.

### **3.3 Printer parameter settings**

The printer can use the special software <setting tool software> to set more parameters through the computer. You can set the printer's language, font, default code page, the printer's Bluetooth device name and password, and print mode. For the setting method, please refer to the file <Setting Tool Software Help>, which is provided with the software.

### **3.4 Printer Label Sensor Calibration**

The label sensor calibration is to adapt to different types of label paper on the market. By adjusting the sensor configuration of the printer, the printer can correctly position the label.

Before calibration, the length of the corresponding label should be

set on the LCD screen. When it is currently in label paper mode, in the off state, first press the **【MODE】** key, then press and hold the [Power] key, when you hear the boot sound, release the [Power] key, and then press the **【FEED】** key twice times, and then release **【MODE】**. The printer enters label calibration mode. And print out "Sensor calibration mode\r\nPress the paper feed key\r\n".

Power off directly to cancel calibration.

After pressing the paper feed button, the printer will feed the paper for a fixed length, and then the LCD will display "calibration passed". During the calibration process, there will be a normal phenomenon of paper feed back. If the paper type configuration is incorrect or the hardware cannot support the current printing paper, the words "Automatically exit if the paper type is set incorrectly" and "Automatically exit if the calibration error is incorrect" will be printed respectively. If the calibration fails, the LCD will display "Calibration failed", please calibrate again.

## 3.5 Restore the printer to default configuration

When the printer configuration item is incorrectly configured and cannot work normally, use this function to restore the factory configuration content.

In the off state, first press the **【MODE】** key, then press and hold the [Power] key, when you hear the boot tone and the LCD screen starts, release the **【POWER】** key, then press the **【FEED】** key three times, then release the Turn on the **【MODE】** key. The printer enters the factory reset mode. And print out the prompt words "Note: Set the recovery system to the default value, press the **【FEED】** key once to confirm. Direct power off to cancel".

Direct power failure cancels recovery.

After pressing the paper feed button, the printer will print out the words "Restore system settings successfully". After recovery is completed, the printer will automatically shut down.



## 3.6 Printer connection and printing

### 3.6.1 USB connection

The SP-L39 printer comes standard with a standard Type-C cable for connecting the printer to the host device. The USB of the printer belongs to the slave device type (DEVICE); the shape and pin definitions are shown in the following figure:

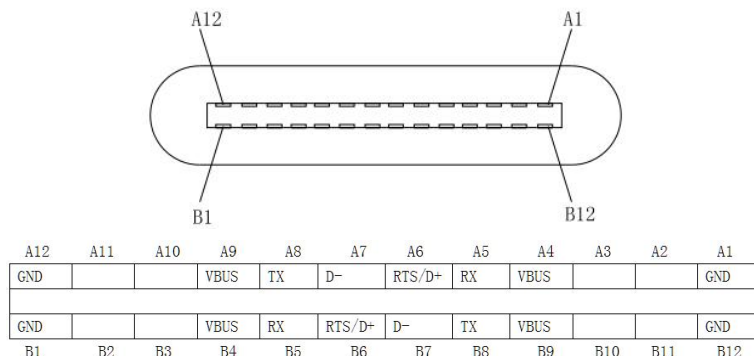

Type-C socket and pin definition

### 3.6.2 Bluetooth connection

Handheld devices, notebook computers, or other information

terminals with a Bluetooth interface can drive SP-L39 to print . The Bluetooth of SP-L39 thermal printer is compatible with Bluetooth 2.0 specification and Bluetooth dual-mode (supports Apple 4.0 and Android 2.0 Bluetooth specification), the power level is CLASS 2, and the effective distance is 10m. The printer's Bluetooth is a slave device. The initial device name is L39 Printer and the initial password is "1234". Users can use the <Setting Tool Software> to modify the device name and password according to their needs. For the method of changing the device name and password, please refer to the help file of the <Setting Tool Software>.

SP-L39 thermal printer needs to be paired with the Bluetooth master device that controls the printer before working, and the pairing is initiated by the master device. The usual pairing process is as follows:

1. Turn on the printer,
2. The main device searches for external Bluetooth devices,
3. If there are multiple external Bluetooth devices, select the L39

Printer

4. Type the password "1234"

5. Complete the pairing.

For the specific pairing method, please refer to the Bluetooth function description of the master device.

Notice:

① When pairing, the SP-L39 thermal printer must be turned on.

② Once the Bluetooth device of the printer is successfully paired with the host Bluetooth device and establishes a link, it will no longer provide search and link services for other primary Bluetooth devices until it is disconnected from the host device linked to it.

③ After the pairing is successful and the connection with the printer is established, the Bluetooth icon on the printer's LCD screen will display the connection status.

### **3.6.3 wifi connection**

Handheld devices with wifi interface can connect to the printer through WeChat to print. The method is as follows:

In the power-off state, press and hold the **【MODE】** key and the **【POWER】** key to turn it on, release the **【POWER】** key, press the **【FEED】** key four times, and then release the **【MODE】** key. The printer enters the network configuration mode. And print out the prompt words “start network configuration” . Use your mobile phone to scan the QR code to configure the network.

### **3.7 Buzzer description**

The printer has a buzzer, it will also give prompt information, the following is the meaning of the prompt information:

One low and one high: Power on.

One high and one low: Shut down.

Cycle of two consecutive lows: The printer has an error state.

### **3.8 Description of LCD display**



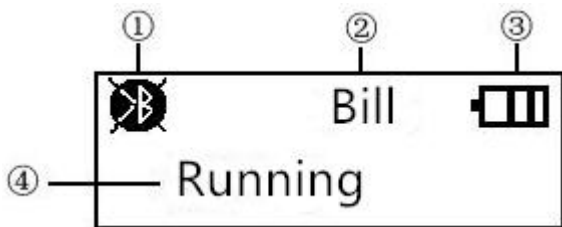

When the printer is turned on, the printer's LCD screen will display the boot prompt information. After the printer is initialized, the LCD

will display the relevant information of the printer. If no data is sent to the printer or no external interface is inserted into the printer within 5 seconds, the LCD will automatically turn off the display until the external interface is inserted into the printer or the external device sends data to the printer, the LCD will display again.

### 1. Label mode



①The icons , , , and  respectively indicate: wifi not connected, bluetooth not connected, bluetooth connected and wifi connected.

③Schematic diagram of the current battery level of the printer. Use the icons , , , respectively, to display the current battery level of the printer, and the icon  will flash when the printer battery is low.

- ④ Text prompt display to show the current status of the printer.





Running is displayed when the printer is in normal standby.

When the printer has a print job, it will display Printing.

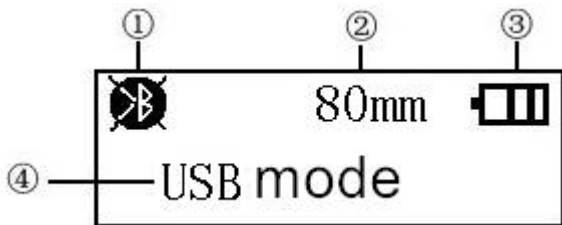

When the printer has an error, it will display out of paper, abnormal temperature, abnormal voltage and abnormal paper cover alarm according to the error status.

## 2. Receipt mode



①When the icon is  it means WiFi is not connected,  means that Bluetooth is not connected,  means Bluetooth is connected, and  means WiFi is connected.

②Display the working mode of different printing paper,80mm、58mm.

③Icons for current battery power of the printer. The icons , ,  for indicating current battery level of the printer. The

icon  will flash when the printer power is low.。

④Text prompt display, where the current status of the printer is displayed in text.

When the printer and peripherals are not connected, it displays: USB mode.

When a USB interface is inserted, it shows: USB is connected.

When the USB interface sends data to the printer, it displays: USB is communicating. When there is Bluetooth connected to the printer and the corresponding port is opened, it shows: Bluetooth is connected.

When there is WiFi connected to the printer and the corresponding port is opened, it shows: WiFi is connected.

When a USB interface is inserted and Bluetooth is connected, it displays:USB and Bluetooth are connected.

When a USB interface is inserted and WiFi is connected, it displays: USB and WiFi are connected.

When the Bluetooth interface sends data to the printer, it shows: Bluetooth is communicating.

When the WiFi interface sends data to the printer, it shows: WiFi is communicating.

## **Chapter 4 Other Information**

### **4.1 Command Programming Manual**

<SP-L39 commands Manual> is a technical manual for engineer to develop printer utility, and users can claim our company for it.

### **4.2 Instruction on Label Paper**

Please do comply with the following instruction if the user adopts adhesive label paper, otherwise it may lead to the inaccurate locating the gaps, which results in the missed or blank receipt.

Requirement on label printing paper:

- 1、 The length of each receipt is less than 200mm.
- 2、 The gap width is less than 3mm, not more than 30mm.
- 3、 Requirement of receipt shape (rectangle or similar to), irregular shape labels are not supported.



## Appendix A

Setting instruction: hit the **【MODE】** button to choose “set” item; press it once, the set item will become the next alternative option, and it will print the present value of the chosen item. Hit the **【FEED】** button to set the value needed, when pressing it once, the value will become the next one in sequence.

After setting, hit the **【MODE】** and **【FEED】** button together, the current value will be saved, and printer enters into normal operation status. Or it won't save the value.

General Setting:

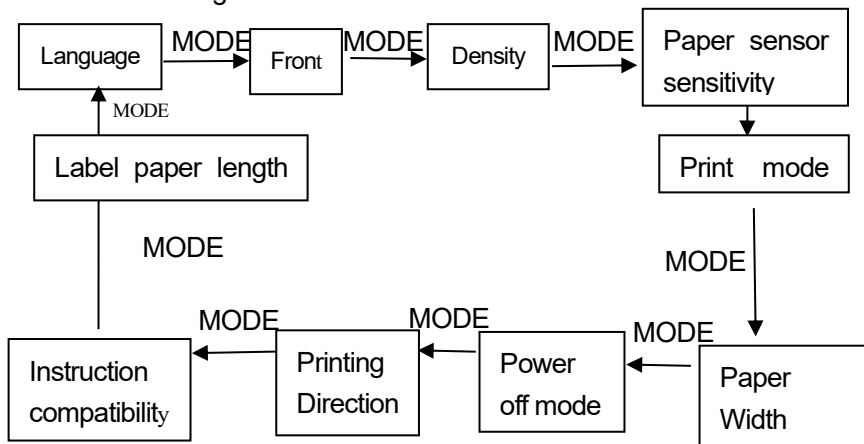

Language:

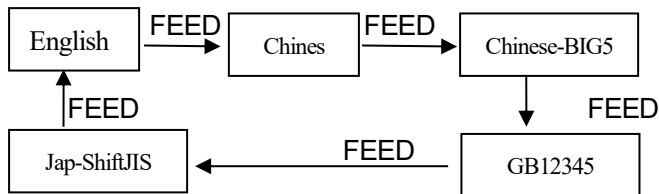

Font:

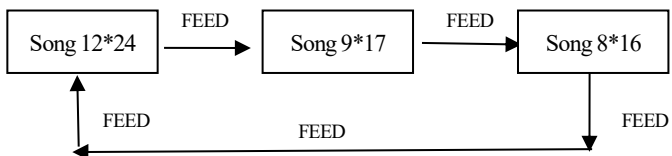

Density:

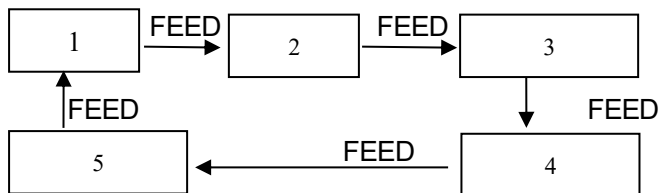

Paper sensitivity setting:

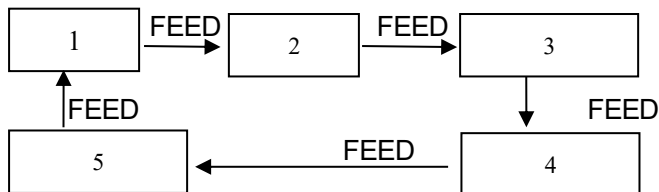

Print Mode:

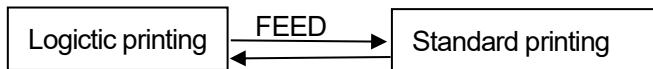

Paper Width:

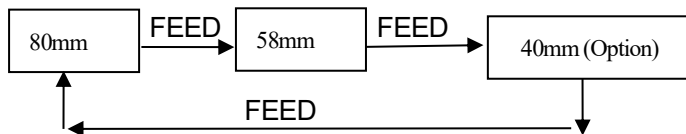

Power off Setting:

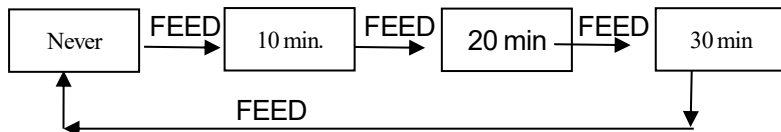

Printing Direction Setting:

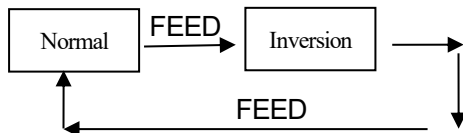

Printing Commands Compatibility:

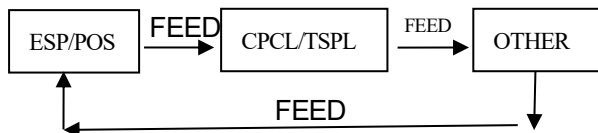

Label Paper Setting:

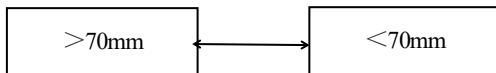

## Appendix B

Setting instruction: hit the **【MODE】** button to choose “set” item; press it once, the set item will become the next alternative option, and it will print the present value of the chosen item. Hit the **【FEED】** button to set the value needed, when pressing it once, the value will alter to the next one in sequence.

After setting, it'll quit the Setting mode automatically and save the current value after 5 seconds.

General Setting:

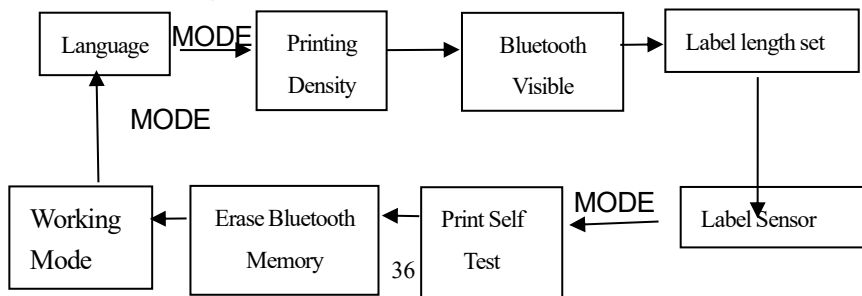

Language Setting:

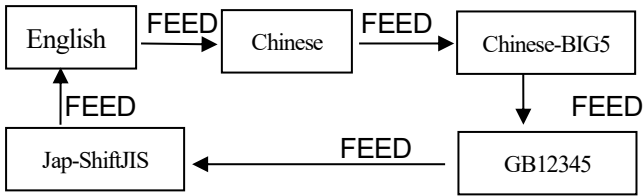

Density Setting:

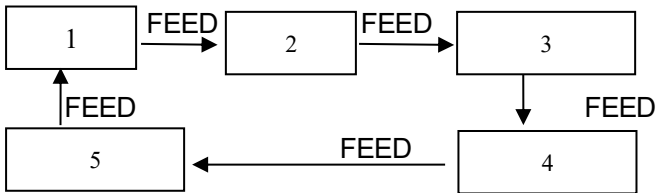

Visible Bluetooth Setting:

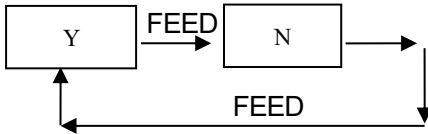

Label Length Setting:



Label Paper Sensitivity Setting:

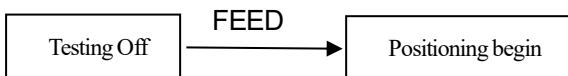

Self Test Paper Print:

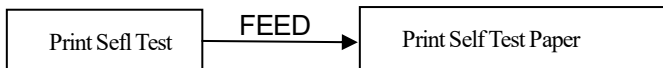

Erase Bluetooth Memory:

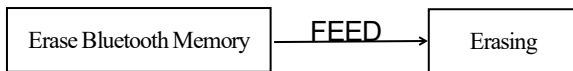

Working Mode:

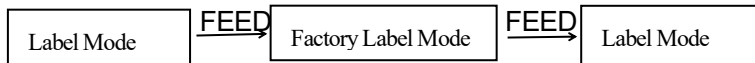

Return down: The manufacturer's label mode corresponds to the offset distance, it is not recommended to modify it directly (slightly)

**Manufacture has right to amend the content of the instruction without prior announcement!**

**Beijing Spirit Tech Dev Co.,Ltd.**

Add: No. 26 Ave. 4, Chuangye Middle Road, Shangdi Information Industry

Park, Beijing, CHINA

Zip code: 100085,

Tel: 010-51661178

FAX: 010-51661178-190

Technical support: 010-51661178-157 010-62969379

Service email: [support@sprinter.com.cn](mailto:support@sprinter.com.cn)