

# SPRT®

## SP-RMD12 MINI THERMAL PRINTER User Manual

VER 1.06

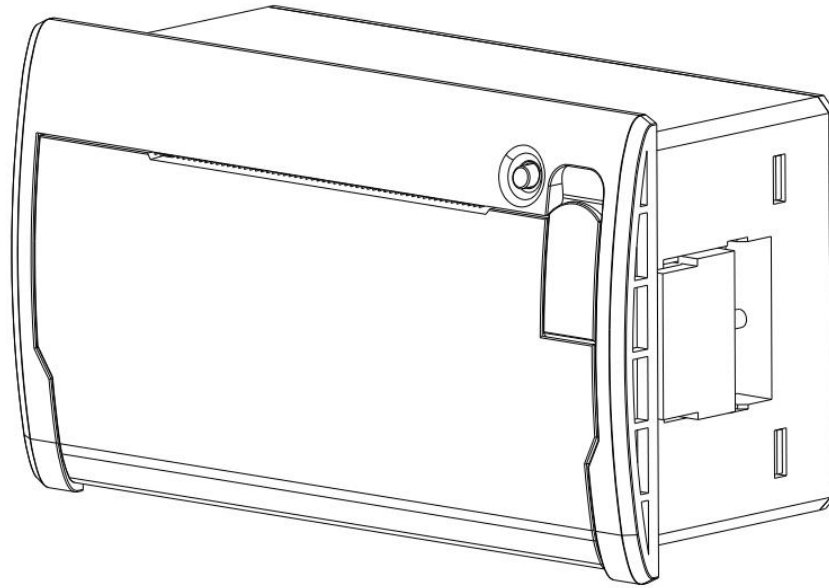

Beijing Spirit Technology Development Co., Ltd

[www.sprt-printer.com](http://www.sprt-printer.com)

# Content

Brief Instruction .....	1
Chapter 1 Characteristics and Performance .....	2
1.1 Main Features .....	2
1.2 Print Performance .....	2
Chapter 2 Install Instruction .....	3
2.1 Outer appearance .....	3
2.2 Outer Dimension .....	4
2.3 Paper Install .....	4
Chapter 3 Operating Instructions .....	5
3.1 Interface connection .....	5
3.1.1 Serial connection .....	5
3.1.2 Parallel interface connection .....	7
3.1.3 USB Interface .....	8
3.1.4 The printer parameter setting .....	8
3.1.5 Power supply connection .....	11
3.2 Light and button operation .....	11
3.3 Self-test and HEX .....	12
3.4 Printer initialization .....	14
Chapter 4 Printing commands .....	15
4.1 Summary .....	15
4.2 Commands Description .....	15
4.2.1 Paper Feeding Commands .....	15
4.2.2 Format Setting Commands .....	16
4.2.3 Character Setting Commands .....	21
4.2.4 User-defined Character Setting Commands .....	26
4.2.5 Graphics Printing and Codepage Choosing Commands .....	28
4.2.6 Initialization Commands .....	32
4.2.7 Data Control Commands .....	32
4.2.8 Chinese Character Print Commands .....	33
4.2.9 Real-time Commands .....	36
4.2.10 Bar Code Printing Commands .....	38
Chapter 5 Using and Maintenance .....	43
5.1 Printing Head Maintenance .....	43
5.2 Other .....	43
Chapter 6 Printer Using under Windows .....	44
Appendix1 Valid Codes Form under ANK printing .....	44
Appendix2 Valid Codes Form under Chinese printing .....	47
Appendix3 Printing Commands Form .....	48

## Brief Instruction

RMD12 series mini printer is a intelligent dot printer toward the 21th century belong to SPRT. The machine adopt new machine with single chip computer, with small volume, light weight, fully functional, high speed, high-definition, beautiful appearance, simple operation, convenient connection. RMD12 series mini printer with full product line, standard installation size, it is the best product to match with medical equipment, fire control station, industrial control and other instruments and for upgrading.

RMD12 thermal printer is mode with the same character set 1 and set 2 RMDIII, according to the characters in the Chinese manner of lattice can print 24 different lattice high 12 \* 24 half-width characters, 8 16 \* 16 dot high half-width characters, Chinese characters have 24 \* 24, 16 \* 16dots, secondary character selection, as well as a large number of mathematical symbols, special symbols, graphics, curve. Can change through the command to print and character spacing characters, you can customize the size of the part code has since detection function.

RMD12 printers have Windows driver, able to directly under PC for printing all kinds of characters, Chinese characters and graphics.

# Chapter 1 Characteristics and Performance

## 1.1 Main Features

- ◇ Using thermal line printing
- ◇ Integrating the print head and circuit with one body, easy to installed
- ◇ Comes with a single chip processor, with standard parallel interface and serial interface, facilitate with various computer or online using intelligent instruments
- ◇ With the command of real-time print for Chinese characters, characters and graphics, Instruction set is compatible with the traditional printer.
- ◇ Support multiple international code page and pre-store bitmap print
- ◇ With self-test function, print all code, high HD characters and beautiful font
- ◇ RMD12 machine type have enough receive buffer 3 k
- ◇ Thermal paper was 57.5 + / - 0.5 mm wide
- ◇ Paper type: 57.5×Ø30mm(MAX)
- ◇ Power supply command:
  - RMD12 S/Q/P/UH Wide Input Range : DC5V~8.5V      Current: 3A
  - RMD12 VS/VQ/VP/VUH Wide Input Range: DC9V~24V    Current: 3A
- ◇ Operating Temp/Humidity: 0~50°C
- ◇ Can be used under DOS and Windows desktop
- ◇ 8dots/mm, 384 dots/line
- ◇ Print speed: 30mm / s
- ◇ TPH: 50KM
- ◇ Installation port size: 103mm×57mm(W×H), depth: 43.5mm
- ◇ Outer dimension: 110mm×64mm×51mm(W×H×D)
- ◇ Printing characters:
  - Chinese: GB Grade1 and Grade 2: 16\*16, 24\*24
  - English: ASCII 5\*7, 12\*24, 8\*16
  - Graphic: support dot matrix graphics, curves and download graphics printing

## 1.2 Print Performance

- ◇ Printing methods: Thermal type printing.
- ◇ Interface: Parallel interface (CENTRONICS compatible) or serial interface (RS - 232 or TTL) or USB interface.
- ◇ Interface connector :
  - Serial: IDC10 pin socket
  - Parallel: IDC26 pin socket

USB :Mini USB B

- ◇ Control code general ESC, FS, GS control code
- ◇ Button SEL for and on-line control, SEL lamp for error alarm and status indication. Usually the lamp is off. Button LF is self-test and paper feeding control button, LF LED is ERROR alarm and power indicator light, the LED will keep lighting after powered on, to indicate the printer is powered on. The combination of Button SEL and LF can modify printer parameters. Flicker frequency has different meaning, the details can refer to the third chapter 3.2.
- ◇ Printing paper: thermal paper, width  $57.5\pm 0.5\text{mm}$
- ◇ MCBF: MCBF (Mean Cycles Between Failure) $(5\sim 15)\times 10^6$
- ◇ Working Temp and RH:  $0\sim 50^{\circ}\text{C}$ , Humidity  $10\sim 80\%$
- ◇ Storage Temp and RH:  $-20\sim 60^{\circ}\text{C}$ , Humidity  $10\sim 90\%$

## Chapter 2 Install Instruction

### 2.1 Outer appearance

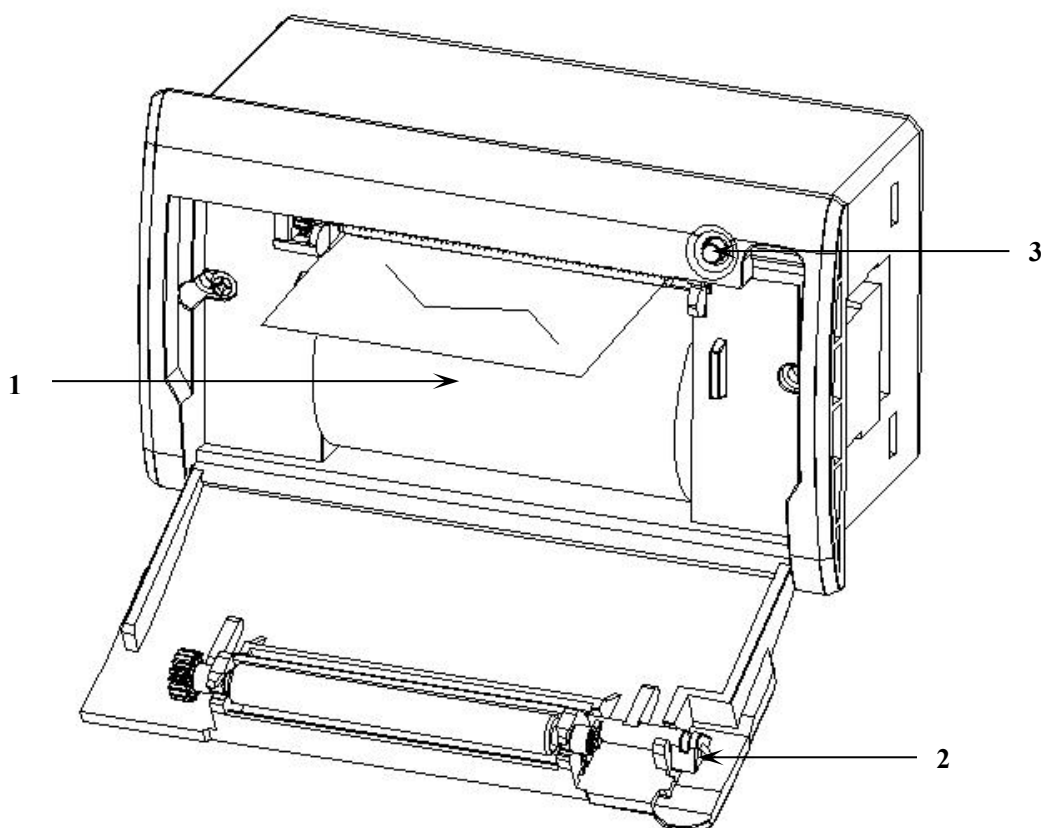

2-1

1. Paper roll
2. Open Handle

### 3. LF, Status Indicator light

## 2.2 Outer Dimension

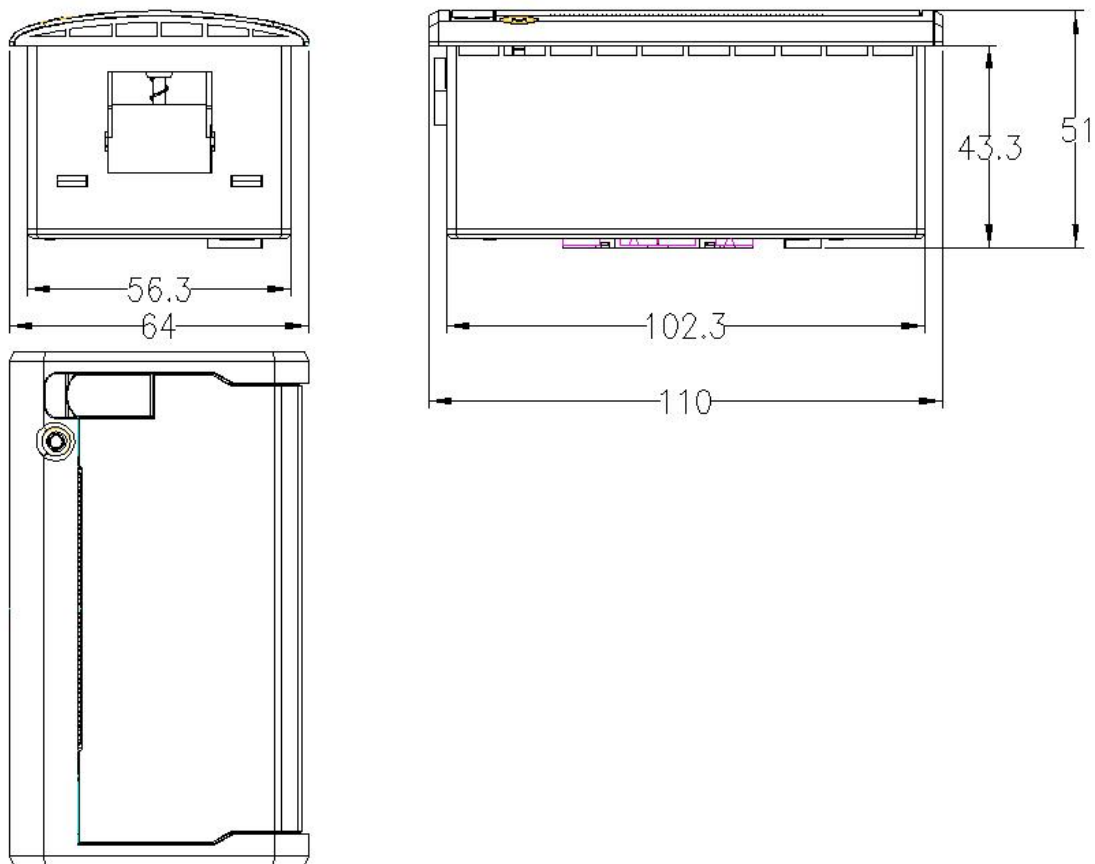

Figure 2—2 SP-RMD12 panel printer Outer Dimension

## 2.3 Paper Install

Press button to open the door. After loading the paper roll and then close the door.

# Chapter 3 Operating Instructions

## 3.1 Interface connection

### 3.1.1 Serial connection

RMD12 Serial interface of RS - 232 serial interface and 485 serial interface.

#### 1. RS-232

232 interface levels for both EIA and TTL, Support RTS/CTS and XON/XOFF handshaking protocol, the interface type is IDC10 PIN socket and PDK-5, each types of socket cords number are defined as follows:

IDC10 pin number definition shown as figure3-1:

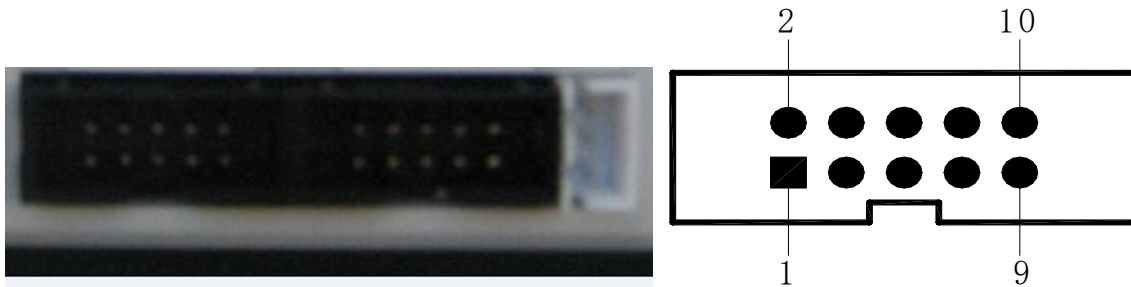

3-1

PDK-5 shown as figure3-2:

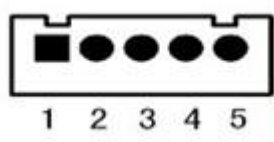

3-2

Serial interface each pin number definition shown as figure 3-1:

Signal Name	IDC10 socket cords number	5PIN socket cords number	Source	Instruction
RXD	3	3	PCB board	Printer receive data from computer
TXD	2	2	printer	Printer send data to computer, when use X-ON/X-OFF handshaking protocol

				agreement, the printer will send control code X-ON/X-OFF to computer
CTS	8	4	printer	When the signal show "MARK", it is means the printer is busy and can not receive data, when the signal show "SPACE", it is mean the printer get ready and can receive data.
DSR	6	1	Printer	when the signal show "SPACE" it is mean the printer online
GND	5	5	—	Signal ground
DCD	1		Printer	Same as CTS

3-1Serial interface pin number definition

Mark: ①"Source" mean the source for the signal

② The signal logic is divided into EIA and TTL level due to insert different sockets; Under the serial interface connect, the baud rate and data structure can be set with button or software, Before out of factory the product has been set to 9600bps, 8 data bits, no calibration and a stop bit; two types of handshaking protocol agreement can be chosen. One is mark control way, other is X-ON/X-OFF agreement, two kinds of handshaking protocol agreement's instructions shown as figure 3--2:

Type of handshaking protocol agreement	Data direction	RS-232C interface signal
Mark control	Data allowable	Signal line 1 and 8 are show Space
	Data disallowed	Signal line 1 and 8 are show Mark
X-ON/ X-OFF control	Data allowable	Send X-ON code 11H on signal line 2
	Data disallowed	Send X-ON code 13H on signal line 2

3-2 Two types of handshaking protocol agreement



### 3.1.2 Parallel interface connection

RMD12 printer's parallel interface is compatible with CENIRONICS, whose interface socket is 26 lines flat cable or replace model. Parallel interface pin number shown as below:

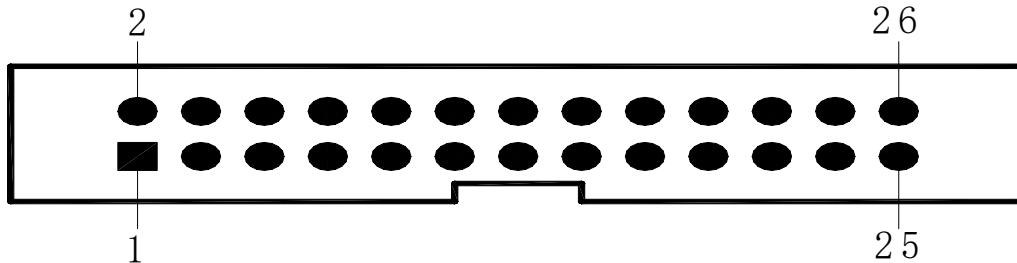

3-4 Parallel interface pin number

Parallel interface pin number definition shown as below:

Cords No.	Signal	Direction	Instruction
1	/STB	input	Gate trigger, rising along the read data.
3	DATA1	Input	Those signals represent the message from 1 to 8, when the logic is "1" of each signal, it is high level, logic show "0" mean low level.
5	DATA2	Input	
7	DATA3	Input	
9	DATA4	Input	
11	DATA5	Input	
13	DATA6	Input	
15	DATA7	Input	
17	DATA8	input	
19	/ACK	output	Pulse reply, "low" level mean the data has been received and printer already to receive next data.
21	BUSY	output	"high" level mean printer is "busy" can not receive data
23	/PE	output	Via resistance drop down to "low" level mean have paper

25	SEL	---	Via resistance pull up to " high" level mean printer online
4	/ERR	output	Via resistance pull up to " high" level mean no trouble
2、 6、 8	NC	---	Not connected
10、 12、 14、 16、 18、 20、 22、 24	GND	---	Ground connect, logic"0" level

3—5 Parallel interface cords define

Mark: ①"input" mean enter into printer, "output" mean output from printer。  
② The signal's logic level is TTL level.

### 3.1.3 USB Interface



Mini USB Connector pin definitions:

PIN	Signal
1	NC
2	D-
3	D+
4	NC
5	GND

### 3.1.4 The printer parameter setting

Printer parameter can be set via two ways:

1. Via software to set

You can download the software set tool, instruction refer to setting tool.

2. Via SET (On back side of printer) and LF Combination set

**Enter the parameter setting:** Press **【SET】** button and connect the power. At this time, green indicator will flash once one second. Release **【SET】** button within three flashes. The printer enters into setting status and print related message. Choose the setting item through **【SET】** button. Press **【SET】** button once, the setting item will go to the next and print out the setting value of this item. Choose the setting value of item through **【LF】** button. Press **【LF】** button once, the setting item will go to the next.

**Exit the parameter Settings:** Press **【SET】** button, after indicator LED flashed three times, release the button. It will print out “Exit Set Mode” notice message. Now the set parameters have been saved. Exit the setting mode and enter into normal working. If you close the power supply of printer directly, the setting parameter will lose.

Summary setting (when Parallel interface there is no baud rate and Serial interface format setting items) :

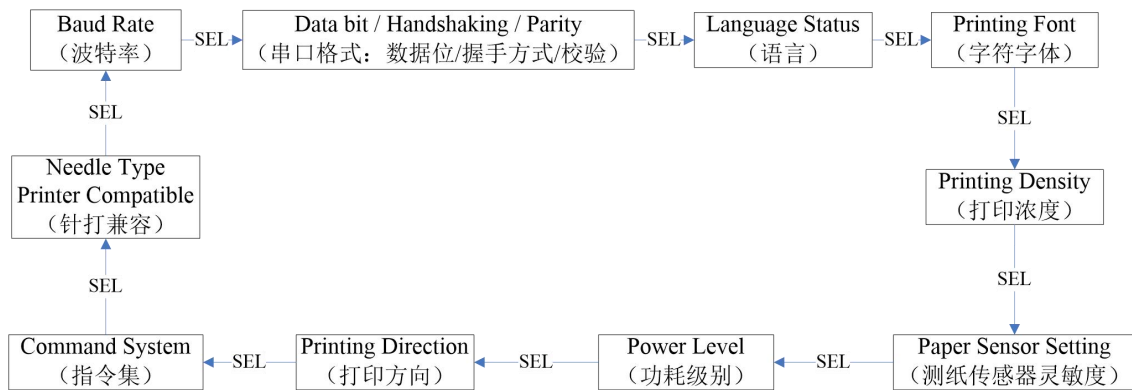

**1. Baud Rate:**

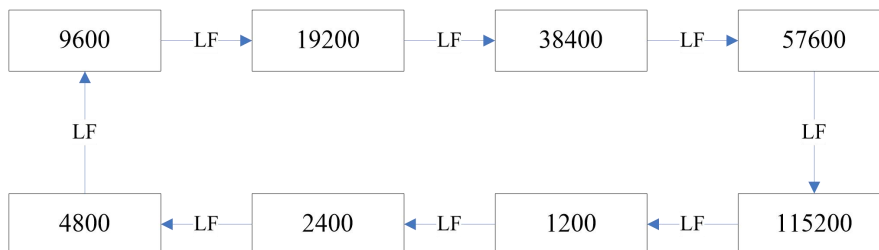

**2.Data bit / Handshaking / Parity:**

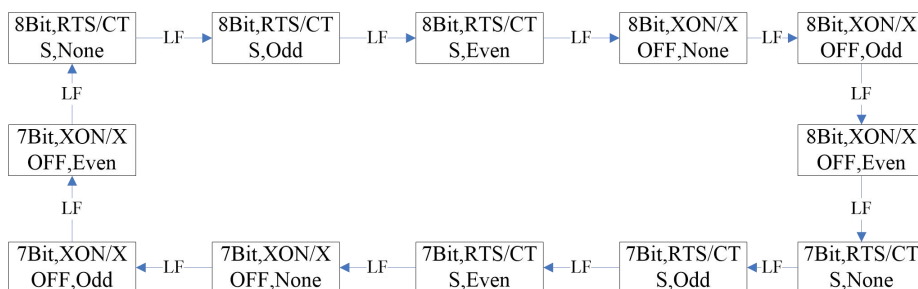

Instructions:

Data Bit: 8bit or 7

Handshaking: RTS/CTS or XON/XOFF

Parity: None or Odd or Even

### 3. Language Status:

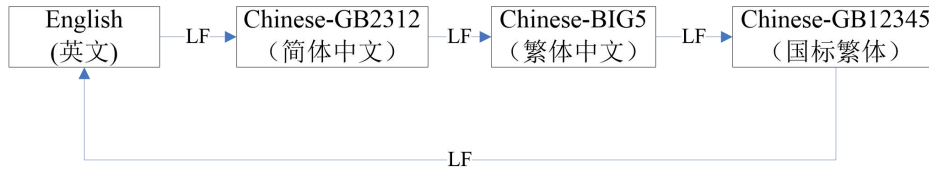

Description:

1. GB12345 with national standard secondary character GB2312 corresponding traditional character.
2. The standard model 24 models only support interface secondary character GB2312 a pattern, 16 point models sup interface BIG5 and traditional GB12345 choice.

### 4. Printing Font:

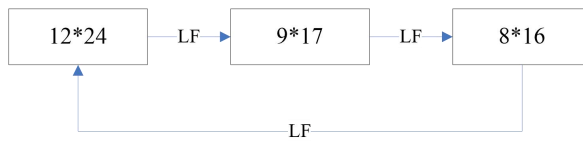

Description: characters font is only effective in Chinese character mode, English mode only 6 \* 8.

### 5. Printing Density:

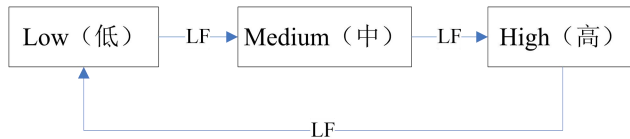

### 6. Paper Sensor Setting:

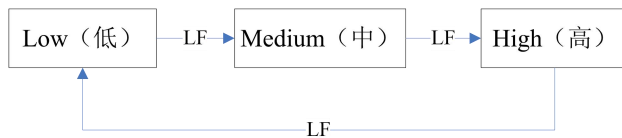

### 7. Power Level:

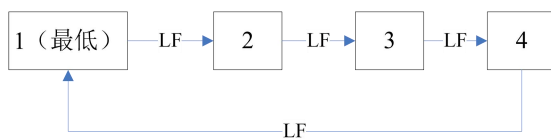

### 8. Printing Direction:

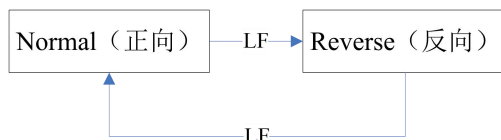

### 9. Command System:

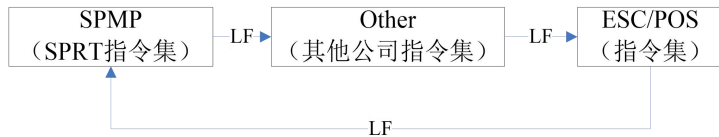

### 10. Dot Matrix Printer Compatible:

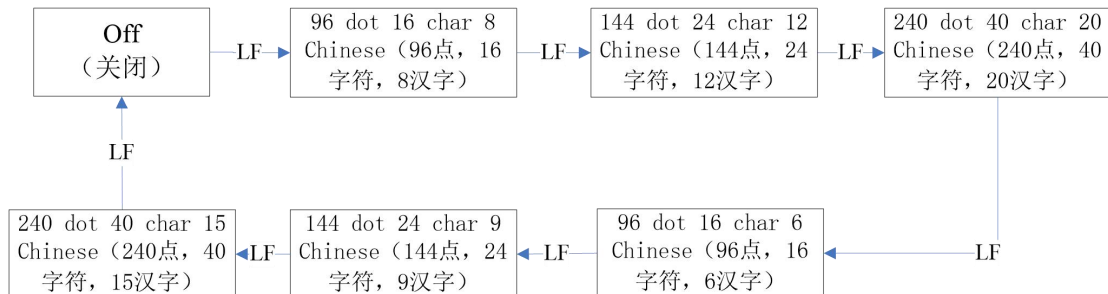

This setting can be used for dot matrix printer models alternatively:

1. After selecting this setting, power consumption level still can be chosen.
2. After selecting this setting, the function of selecting font size for characters and Chinese characters will be not supported.

### 3.1.5 Power supply connection

RMD12 S/Q/P/UH Wide Input Range:DC5V~8.5V Electricity: 3A  
 RMD12 VS/VQ/VP/UH Wide Input Range: DC9V~24V Electricity: 3A  
 The power socket interface is showed as pic. 3-4; the power interface sequential pins are indicated as chart. 3-5.

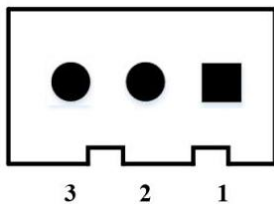

Pin No.	Pin Definition	Instruction
1	VIN	Power input
2	NC	suspending
3	GND	Ground wire

Pic. 3-4 power socket interface    Pic. 3-5 power interface sequential pin

Note: In version PH the pin 2 is suspending and with data receiving function (RXD Find), which can be optional.

### 3.2 Light and button operation

The function of each button is different according to the different working mode. Refer the detailed to 3.1.4. The normal working mode is as below,

#### SET

**【SET】** button is in the back of the printer, electrical outlet diagonal holes. Press and hold on [SET] button to enter into setup mode. After normal power, this key is invalid.

## LF

Press[ LF ]button to feed paper. Press again to stop paper feeding.

## Power indicator (green)

Indicates on/off status of power.

Power and Error status indicator LED share one green light

Light status	Instruction
Stay lighting	Normal working
Blink once, off 1 second	Lack of paper, waiting for has returned to normal after the paper
Blink twice, off 1 second	Printer head is overheat, it will be back to normal work automatically after cool down.
Flashing 3 times, off 1 second	The heating plate of printer head is damaged, irreversible error, need to repair.

Mark: When the printer is in a state of busy, green light will turn off.

## 3.3 Self-test and HEX

Self-test can test whether the printer is working properly or not. If the self-test receipt can be printed correctly, it means the printer is normal except the interface with the host. Otherwise, the printer will need to be repaired.

### Self-test receipt and analysis

In self-test receipt, software version, interface forms, characters and other configuration information are printed. Self-test receipt shown in the figure below:

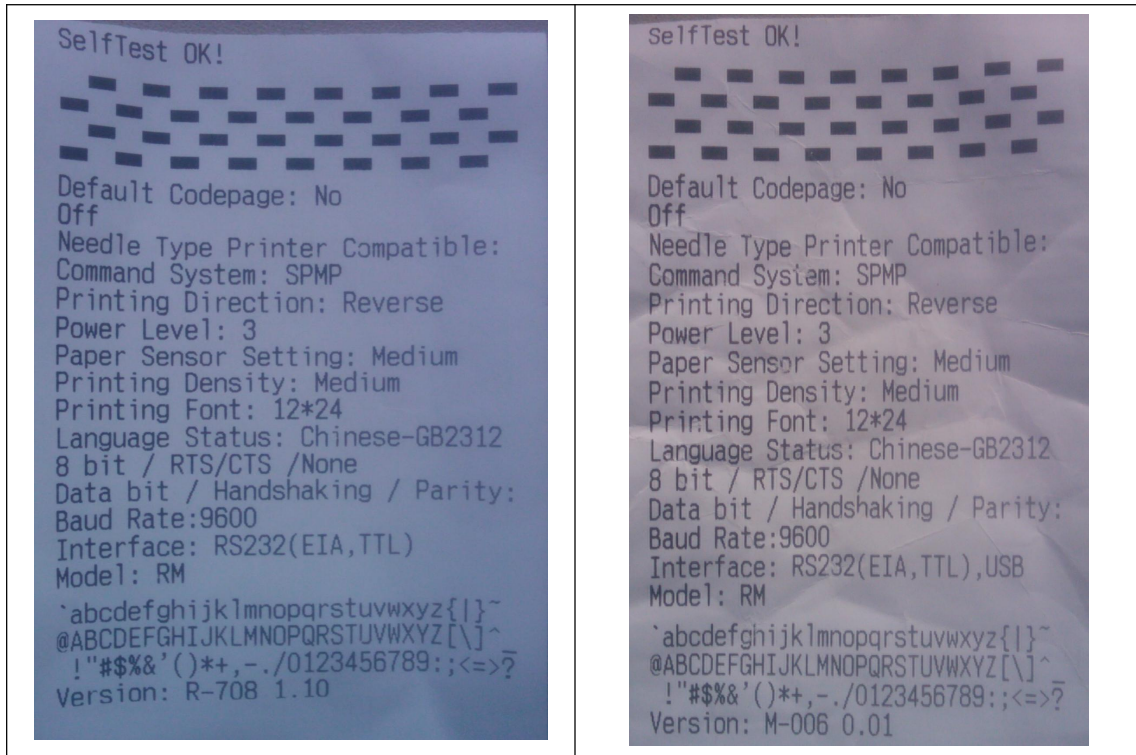

Figure 3—4 self-test receipt

The figure is self-test receipt for serial interface model. The printing sequence is from the bottom to top, as the parameters on above pictures were shown as English language, below is main parameters information in English and Chinese for reference.

序号 No.	自检项目英文内容 Contents on Self-test receipt in English	Contents on Self-test receipt in Chinese 自检项目中文说明
1	Version: R-708 1.10	版本号: R-708 1.10
2	Model: RM	机型: RM
3	Interface: RS232(EIA, TTL)(Serial interface)	接口类型: RS232串口(EIA, TTL)
	Interface:RS232(EIA TTL),USB(USB interface)	接口类型: RS232串口和USB口共存
4	Baud Rate: 9600(Parallel model, no this parameter)	波特率: 9600
5	Data bit/Handshaking/Parity:8 bit / RTS/CTS / None(Parallel model, no this parameter)	串口数据位/握手方式/校验方式:

		8位/标志控制/无校验
6	Language Status:Chiese-GB2312	语言：简体中文(国标一二级字库)
7	Printing Font: 12*24	字符字体：12*24
8	Printing Density: Medium	打印浓度：中
9	Paper Sensor Setting: Medium	测纸传感器灵敏度：中
10	Power Level: 3	功耗级别：3
11	Printing Direction: Reverse	打印方向：反向
12	Command System: SPMP	指令集：SPRT微打指令集
13	Needle Type Printer Compatible: off	针打兼容:关闭
14	Default Codepage:No	默认代码页：无

Note:

1. As the default set of printers maybe different from factory, the fond and all parameters shown on self-test receipt should be in kind prevail, above pictures are just for reference.

2. The specific content of each setting item can refers to “3.1.4”section, you can print a self-test after setting parameters manually to confirm if set up successfully or not.

#### **Self-test method:**

Hold down the "LF" button and turn on the printer, then loosen the button in 3 seconds, the printer will print out the self-test list.

#### **Hex printing method**

Hold the [LF] button and connect the power. At this time, the red indicator light will flash once one second. After three flashes of indicator, loosen **【LF】** button. The red indicator will continue to flash. After flashing three times again, the flashing stops. The printer will print out “Hexadecimal Dump”. Now the printer enters into the hex printing mode.

### **3.4 Printer initialization**

There are two methods for the printer initialization. One is to use the control code ESC @, by the host sends a command to the printer, through which using software initialization. The second is to restart the printer.



# Chapter 4 Printing commands

## 4.1 Summary

All the printing commands of SP-RMD12 are fully compatible with traditional ESC printing commands. The description form of each command is as following,

<u>Command name</u>	<u>Function</u>
Format:    ASCII:	the standard ASCII character sequence
Decimal:	the Decimal number sequence
_____Hexadecimal:	<u>the Hexadecimal number sequence</u>
_____	Explanation: the function of command and usage method

Example: some examples are listed to illustrate the command for better understanding.

The following is the description of each command according to the function of each command.

## 4.2 Commands Description

### 4.2.1 Paper Feeding Commands

<u>LF</u>	<u>Feed Line</u>
Format:    ASCII:LF	
Decimal:    10	
_____Hexadecimal:    0A	_____
Explanation: The printer prints the current line and feeds paper forwards one line.	
Remark: One line means the current character line.	
<u>ESC J</u>	<u>n Dot Line Feed</u>
Format:    ASCII:    ESC    J    n	
Decimal:    27    74    n	
_____Hexadecimal:    1B    4A    n	_____
	Explanation:

The printer feeds paper n dot lines. n=1~255.

This command doesn't send carriage return and feed line. It won't influence the later feed line command.

If you need to feed paper immediately but no carriage return, can use ESC J command.

Line spacing will be enlarged automatically when using commands ESC V, ESC W and FS W for enlarging characters.

<u>ESC 1</u>		<u>Set n Dot-line Spacing</u>			
Format:	ASCII:	ESC	1	n	
	Decimal:	27	49	n	
	Hexadecimal:	1B	31	n	Explanation:

The n dot-line spacing is set for future Line Feed command. n=0~255

Default setting n=3 for text printing, n=0 for bitmap printing when using ESC K command.

The BASIC programs for observing the effect of this command are as

below: FOR I=1 TO 11 STEP 2

```
LPRINT CHR$(27);CHR$(49);CHR$(I); ' ESC 1 set line spacing
```

```
LPRINT "RMWD TEST" ' Print character string and feed line
```

```
NEXT I
```

The print result of the above is as following:

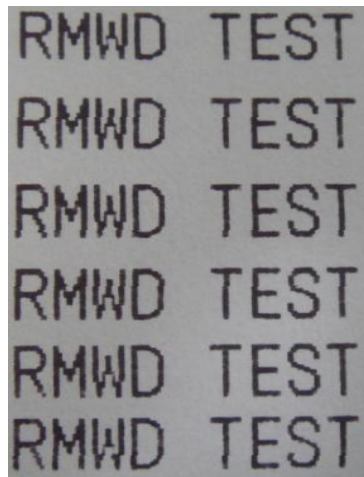

## 4.2.2 Format Setting Commands

ESC B Set Vertical Tab Value

Format:	ASCII:	ESC	B	n1	n2	n3...NUL
	Decimal:	27	66	n1	n2	n3...0
	Hexadecimal:	1B	42	n1	n2	n3...00

Explanation:

The vertical tab positions are entered as n1, n2 and so on. Character NUL is added at the end to indicate that the command is over.

VT command is to carry out vertical tab and the paper is fed to the next vertical position. All input vertical tab positions can be deleted by using this command in ESC B NUL format.

Example: set three vertical tab values at 2<sup>nd</sup> line, 5<sup>th</sup> line, 8<sup>th</sup> line in one page, you can send the following commands:

ASCII:	ESC	B	STX	ENQ	BS	NUL
Decimal:	27	66	2	5	8	0
Hexadecimal:	1B	42	02	05	08	00

The BASIC programs about the above example are as below:

```
LPRINT CHR$(27); "B"; CHR$(2); CHR$(5); CHR$(8); CHR$(0); 'ESC B command
      LPRINT CHR$(11); 'VT command
      LPRINT "SPRM1"; 'print character string
      LPRINT CHR$(11); 'VT command
      LPRINT "SPRM2"; 'print character string
      LPRINT CHR$(11); 'VT command
      LPRINT "SPRM3" 'print character string
```

The print result of the above program is as following:

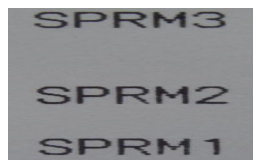

VT Carry out Vertical Tab Value

Format:	ASCII:	VT
	Decimal:	11
	Hexadecimal:	0B

Explanation: Feed paper to the next vertical tab position which is set by ESC B

command.

Notice: if there is no vertical tab value setting, or the current position equals or is beyond the last vertical tab position, VT command is to feed paper one line only (same to LF command).

<u>ESC D</u>		<u>Set Horizontal Tab Value</u>			
Format:	ASCII:	ESC	D	n1 n2 n3...NUL	
	Decimal:	27	68	n1 n2 n3...0	
	Hexadecimal:	1B	44	n1 n2 n3...00	

Explanation:

The horizontal tab positions are entered as n1, n2 and so on, all of which should be within the line width of this model printer. Character NUL is added at the end to indicate that the command is over.

All set horizontal tab positions can be deleted by using this command in ESC D NUL format.

Command HT carry out horizontal tab.

Example: set three horizontal tab values at 2<sup>nd</sup>, 9<sup>th</sup> line, 14<sup>th</sup> character position in one line,

ASCII:	ESC	D	STX	HT	SO	NUL
Decimal:	27	68	2	9	14	0
Hexadecimal:	1B	44	02	09	0E	00

The BASIC programs for this example are as below:

```
LPRINT "12345678901234567890123456789012" 'Ruler
LPRINT CHR$(27); CHR$(68);CHR$(2);CHR$(9);CHR$(14); CHR$(0); 'ESC D
command
LPRINT CHR$(9); 'HT command
LPRIN "HT1"; 'print character string
LPRINT CHR$(9); 'HT command
LPRINT "HT2"; 'print character string
LPRINT CHR$(9); 'HT command
LPRINT "HT3"; 'print character string
LPRINT CHR$(13);
```

The print result of the above program is as following:

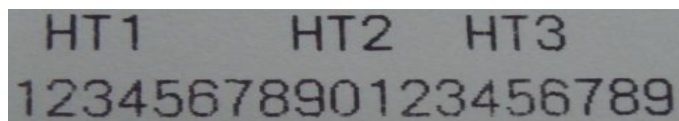

```
HT1 HT2 HT3
1234567890123456789
```

HT Carry out Horizontal Tab Value

Format:	ASCII:	HT
	Decimal:	9
	Hexadecimal:	09

Explanation:

The print position is advanced to the next horizontal tab position which is set by ESC D command.

Remark: If there is no horizontal tab value setting, or the current position equals or is beyond the last horizontal tab position, HT command won't be carried out. If the horizontal tab position is beyond the current line width, HT command won't be carried out either.

ESC f Print Blank Characters or Lines

Format:	ASCII:	ESC	f	m	n
	Decimal:	27	102	m	n
	Hexadecimal:	1B	66	m	n

Explanation:

When m=0, ESC f NUL n will command to print n blank characters

When m=1, ESC f SOH n will command to print n blank lines. n=0~255.

Remark:

When m=0, if the value of n is beyond the current line width, the printer will continue to print blank in the next line.

When m=1, paper will feed n current line heights.

Example: print 6 blank characters in one line, you can send the following commands:

ASCII:	ESC	f	NUL	ACK
Decimal:	27	102	0	6
Hexadecimal:	1B	66	00	06

Another example: print 6 blank lines, you can send the following commands:

ASCII:	ESC	f	SOH	ACK
Decimal:	27	102	01	6
Hexadecimal:	1B	66	01	06

ESC I Set Left Margin

Format:	ASCII:	ESC	I	n
	Decimal:	27	108	n
	Hexadecimal:	1B	6C	n

Explanation:

The value of n should be in the range from 0 to the line width of this model printer. Default n=0, that means no left margin.

This command sets absolute position, and won't be influenced by character commands ESC U and ESC W.

Example: set left margin value to 12, you can send the following commands:

commands:

ASCII: ESC 1 ACK Decimal: 27 108 12

Hexadecimal: 1B 6C 0C

The BASIC programs for this example are as below:

```
LPRINT "1234567890123456" 'Ruler
```

```
LPRINT CHR$(27); CHR$(108); CHR$(12); 'ESC 1 command
```

```
LPRINT "123456789012345678901234567890"
```

The print result is as following:

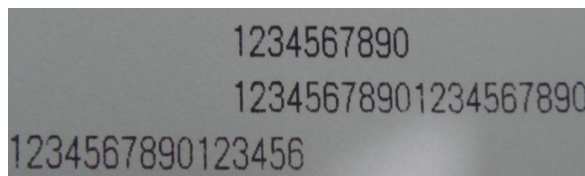

ESC Q Set Right Margin

Format:	ASCII:	ESC	Q	n
	Decimal:	27	81	n
	Hexadecimal:	1B	51	n

Explanation:

The value of n should be in the range from 0 to the line width of this model printer.

Default n=0, that means no right margin.

This command sets absolute position, and won't be influenced by character commands ESC U and ESC W.

After setting this command, the printer will carry out carriage return and feed line as long as the right margin position is reached.

Example: set right margin value to 12, you can send the following

commands: ASCII: ESC Q ACK

Decimal: 27 81 12

Hexadecimal: 1B 51 0C

The BASIC programs for this example are as below:

```
LPRINT "12345678901234567890123456789012" 'Ruler
```

```
LPRINT CHR$(27); CHR$(81);CHR$(12); 'ESC Q command
```

```
LPRINT "123456789012345678901234567890";
```

```
LPRINT
```

```
"1234567890123456789
```

0" The print result is as following:

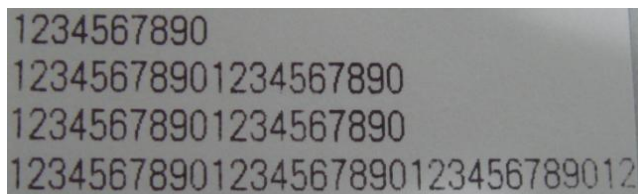

ESC P Set Character Space

Format: ASCII: ESC P n

Decimal: 27 112 n

Hexadecimal: 1B 70 n

---

Explanation:

This command is used to set space dot between characters, which is also valid for Chinese characters.

Default n=0, means no space between characters. (dot is absolute value and won't be influenced by enlarging or narrow commands), n=0~255

### 4.2.3 Character Setting Commands

ESC U Enlarge Width

Format: ASCII: ESC U n

Decimal: 27 85 n

Hexadecimal: 1B 55 n

---

Explanation:

After inputting this command, the characters, graphics and Chinese characters are printed at n times of normal width, n=1~8. Default n=1 when the dots are 24, while default n=2 when the dots are 16. These are normal printing width.

Remark: n=1~8, the other value of n will be invalid.

The BASIC programs for observing the enlarging effect of this command are as below:

```
FOR I=1 TO 3
LPRINT "CHR$ (27); CHR$ (85);CHR$ (I); 'ESC U command
LPRINT "SPRM"; 'Print character string
NEXT I 'CR command
```

The print result is as following:

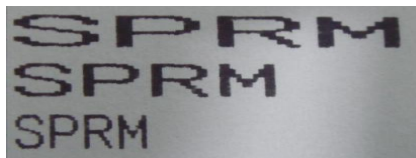

ESC V	Enlarge Height		
Format: ASCII:	ESC	V	n
Decimal:	27	86	n
Hexadecimal:	1B	56	n

Explanation:

After inputting this command, the characters, graphics and Chinese characters are printed at n times of normal height, n=1~8. Default n=1 when the dots are 24, while default n=2 when the dots are 16. This command should be sent out at the beginning of one line.

Remark: n=1~8, the other value of n will be invalid.

The BASIC programs for observing the enlarging effect of this command are as below:

```
FOR I=1 TO 3 ' from 1 to 3 times
LPRINT CHR$ (27); CHR$ (86); CHR$ (I); 'ESC V command
LPRINT "SPRM"; 'Print character string
NEXT I
```

The print result is as following:



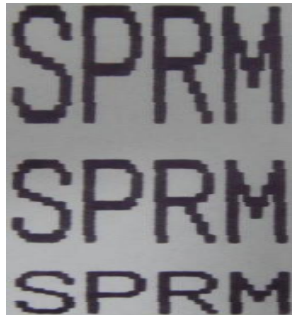

<u>ESC W</u>		<u>Enlarge Width and Height</u>		
Format:	ASCII:	ESC	W	n
	Decimal:	27	87	n
	Hexadecimal:	1B	57	n

Explanation:

After inputting this command, the characters, graphics and Chinese characters are printed at n times of normal width and height, n=1~8.

Remark: n=1~8, the other value of n will be invalid.

```
FOR I=1 TO 3                                ' from 1 to 3 times
LPRINT CHR$ (27); CHR$ (87); CHR$ (I);     'ESC W command
LPRINT "SPRM";                               'Print character string
NEXT I
```

The print result is as following:

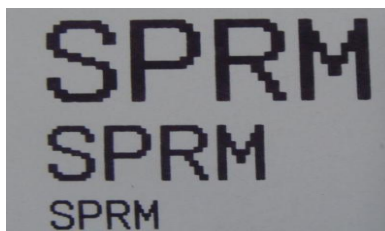

<u>ESC -</u>		<u>Select/cancel Underline Print</u>		
Format:	ASCII:	ESC	-	n
	Decimal:	27	45	n
	Hexadecimal:	1B	2D	n

Explanation:

When the lowest dot n=1, select underline print; when the lowest dot n=0, cancel underline print.

All characters including spaces will be printed out with underline after selecting underline print command, unless cancel the underline print command. This command is

also valid for Chinese characters.

Remark: Only the lowest dot of n is valid. Default n=0.

The BASIC programs for observing the effect of this command are as below:

```
LPRINT CHR$(27); CHR$(57); CHR$(2); ' Enlarge the width and height twice
```

```
LPRINT "SPRM";
```

```
LPRINT CHR$(27); CHR$(45); CHR$(1); ' Select underline print
```

```
LPRINT "SPRM"; ' SPRM print with underline
```

```
LPRINT CHR$(27); CHR$(45); CHR$(0); ' Cancel underline print
```

```
LPRINT "SPRM";
```

The print result is as following:

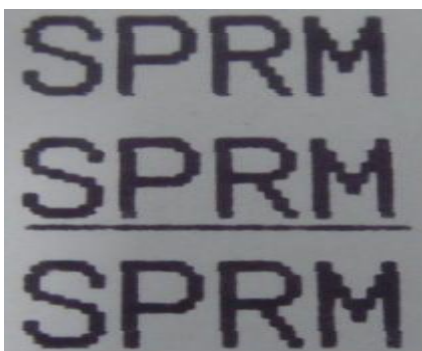

ESC + \_\_\_\_\_ Select/prohibit Up-line Print

Format: ASCII: ESC + n

Decimal: 27 43 n

Hexadecimal: 1B 2B n

Explanation:

When the lowest dot n=1, select up-line print; when the lowest dot n=0, prohibit up-line print.

All characters including spaces will be printed out with up-line after selecting up-line print, unless prohibit the up-line print command. This command is also valid for Chinese characters.

Remark: Only the lowest dot of n is valid. Default n=0.

The BASIC programs for observing the effect of this command are as below:

```
LPRINT CHR$(27); CHR$(57); CHR$(2); ' Enlarge the width and height twice
```

```
LPRINT "SPRM";
```

```
LPRINT CHR$(27); CHR$(43);CHR$(1); ' Select up-line print
```

LPRINT "SPRM"; ' SPRM print with up-line

LPRINT CHR\$ (27); CHR\$ (43);CHR\$ (0); ' Cancel up-line print

LPRINT "SPRM";

The print result is as following:

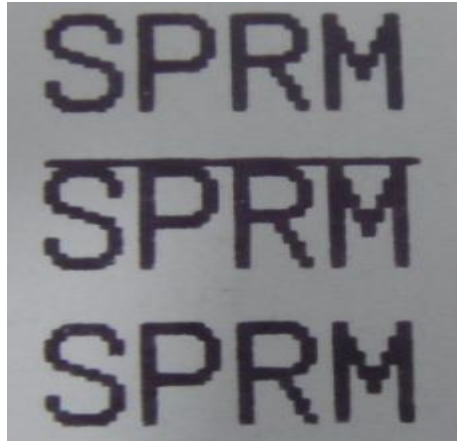

ESC i Select/prohibit Reverse White Print

Format:	ASCII:	ESC	i	n
	Decimal:	27	105	n
	Hexadecimal:	1B	69	n

Explanation:

When the lowest dot n=1, select reverse white print; when the lowest dot n=0, prohibit reverse white print. Reverse white print is printing in the black background, just like the film of photography. The normal printing is that printing black characters in white background. The default is prohibiting reverse white print.

Remark: Only the lowest dot of n is valid. Default n=0.

The BASIC programs are as below:

LPRINT CHR\$ (27); CHR\$ (105); CHR\$ (1); ' Select reverse white print

LPRINT "SPRD"

The print result is as following:



ESC c Select/prohibit Reverse Print

Format:	ASCII:	ESC	c	n
	Decimal:	27	99	n
	Hexadecimal:	1B	63	n

---

Explanation:

When the lowest dot n=1, select reverse print; when the lowest dot n=0, prohibit reverse print.

Remark: Only the lowest dot of n is valid. Default n=1.

Notice: Reverse print not only support character mode but also support graphics mode and Chinese character mode. When print the graphics in reverse direction, pay attention to the printing sequence of graphic units, please check ESC K command.

ESC 6 Choose Characters Set 1

Format:	ASCII:	ESC	6
	Decimal:	27	54
	Hexadecimal:	1B	36

---

Explanation : After inputting this command, all the characters will be printed out according to the Characters Set 1 in ANK.

ESC 7 Choose Characters Set 2

Format:	ASCII:	ESC	7
	Decimal:	27	55
	Hexadecimal:	1B	37

---

Explanation : After inputting this command, all the characters will be printed out according to the Characters Set2 in ANK.

#### 4.2.4 User-defined Character Setting Commands

ESC & User Define Character

Format:	ASCII:	ESC	&	m	n1	n2.....n6
	Decimal:	27	38	m	n1	n2.....n6
	Hexadecimal:	1B	26	m	n1	n2.....n6

---

Explanation : This command permits user to define one character. Parameter m is

character code the user defines,  $m=32\sim 255$ ; parameter  $n_1, n_2, \dots, n_6$  is structure code to define this character. The character dots should be 6x8, which means 6column and 8dots each column. There is one character byte in each column and the MSB is on the tope as below picture,

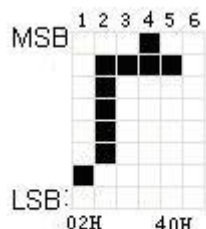

User-defined character is saved in RAM and will be lost after power off. If several ESC & commands use the same  $m$  value, only the last one is valid. At most 32 characters can be defined by users. Ref: ESC% and ESC: commands.

ESC %	Replace User-defined Character						
Format: ASCII:	ESC %	$m_1$	$n_1$	$m_2$	$n_2, \dots, m_k$	$n_k$	NUL
Decimal:	27	37	$m_1$	$n_1$	$m_2$	$n_2, \dots, m_k$	$n_k$ 0
Hexadecimal:	1B	25	$m_1$	$n_1$	$m_2$	$n_2, \dots, m_k$	$n_k$ 00

Explanation:

This command is used to replace character  $n$  in current characters set to user-defined character  $m$ . After using this command, the user-defined character  $m$  will be printed out instead of character  $n$  in current characters set.

$m_1, m_2, \dots, m_k$  is user-defined character code.

$n_1, n_2, \dots, n_k$  is replaced character code in current character set.

Both the value of  $m$  and  $n$  should be  $32\sim 255$ . Subscript  $k$  should be  $1\sim 32$ . The largest character number which can be replaced is 32. Character NUL is added at the end to mean the command is over. Ref: ESC % and ESC : command.

Remark: No matter in Chinese mode or character mode, replacing character will be printed when printing this character code.

ESC :	Recover Character in Character Set	
Format: ASCII:	ESC	:
Decimal:	27	58
Hexadecimal:	1B	3A

Explanation:

This command is used to recover original character in character set. This character has been replaced by user-defined character through command ESC % previously. However, the used-defined character won't be deleted from RAM and still can be used through ESC % command.

The BASIC programs to observing the effect of ESC &, ESC % and ESC : commands are as below:

- 10 LPRINT CHR\$(27); "W"; CHR\$(8); 'Enlarge 8times from Width and Height
- 20 LPRINT CHR\$(27); "&"; CHR\$(65); 'ESC & command

```

30 LPRINT CHR$(&H02); CHR$(&H7C); CHR$(&H40);
40 LPRINT CHR$(&HC0); CHR$(&H40); CHR$(&H00);
50 LPRINT CHR$(27); "%"; CHR$(65); CHR$(65); CHR$(0); 'ESC % command
60 LPRINT CHR$(65); CHR$(13); 'print user-defined character
70 LPRINT CHR$(27); CHR$(58); 'ESC : command
80 LPRINT CHR$(65); 'print original character

```

The print result of the above programs is as following:



## 4.2.5 Graphics Printing and Codepage Choosing Commands

ESC K	Print bit-map graphics
Format: ASCII:	ESC K n1 n2....data.....
Decimal:	27 75 n1 n2....data.....
Hexadecimal:	1B 4B n1 n2....data.....

Explanation:

This command is used to print  $(n2 \times 256 + n1) \times 8$  bit map. The width of this graphics is  $(n2 \times 256 + n1)$  dots and the height is 8 dots. Each column has 8 dots and can be presented by a 8-bit byte, the MSB is on the top.

The values of  $n1$ ,  $n2$  denote a 16-bit binary data,  $n1$  is LSB,  $n2$  is MSB, which mean that the width of printed bitmap through ESC K command is  $n2 \times 256 + n1$ . In our printer series,  $n2=0/1$ . The sum of dots number should be  $\leq 384$ . Data are the bytes content of each column in this graphics. The bytes number should equal to  $n2 \times 256 + n1$ .

Remark: If the width of printed graphics is beyond the remaining width of current line, the beyond part of graphics won't be printed out and the printed position will change to the next line.

For example: If you want to print two Chinese characters “中文” with ESC K command, the bit- map for the two Chinese is as the below figure shows. Each character is composed by  $7 \times 8$  dots to 7 columns, there is a space between the two characters, so totally there are 15 columns, then  $n1=15$ ,  $n2=0$ , the 15-byte data showed in hexadecimal are as follows:  
7C, 44, 44, FF, 44, 44, 7C, 00, 41, 62, 54, C8, 54, 62, 41

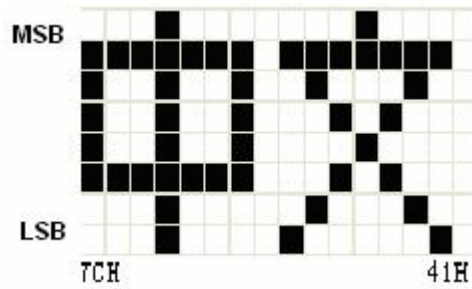

The BASIC programs for this example are as below:

```
LPRINT CHR$(27); "W"; CHR$(4); 'Enlarge the width and height 4 times
LPRINT CHR$(27); "K"; CHR$(15); CHR$(0); 'ESC K
command LPRINT CHR$ (&H7C);
CHR$ (&H44); CHR$ (&H44); CHR$ (&HFF); LPRINT
CHR$ (&H44); CHR$ (&H44); CHR$ (&H7C); CHR$ (&H0);
LPRINT CHR$ (&H41); CHR$ (&H62); CHR$ (&H54);
CHR$ (&HC8); LPRINT CHR$ (&H54);
CHR$ (&H62); CHR$ (&H41);
LPRINT CHR$(10); CHR$ (&H13); 'enter to print text
```

The print result is as following:

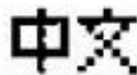

ESC ' Print Curve I Format: ASCII: ESC

Decimal: 27 39 mL mH n1L n1H n2L n2H.....nIL nlh 13

Hexadecimal: 1B 27 mL mH n1L n1H n2L n2H.....nIL nlh

OD

Explanation:

This command is used to print curve along the paper-feeding direction. The value of m is the number of curves to be printed, m=0~255.

There are m dots of curve in one horizontal line. n1L n1H n2L n2H.....nIL nIH presents the positions of these m curves. The numbers of nIL or nIH should equal to m. Each dot should be within the largest dots numbers of printer. The last CR ("enter") is used to print out this dot line. The whole m curves are printed out through each dot line by n1L n1H n2L n2H.....nIL nIH data.

Remark: The dot whose position is beyond the paper width won't be printed out. This command is valid no matter there is OD or not.

ESC , Print Curve II ( supplement dots automatically to be full curve)

Format: ASCII: ESC , m n1L n1H n2L n2H.....nL nH CR  
Decimal: 27 44 m n1L n1H n2L n2H.....nL nh 13  
Hexadecimal: 1B 2C m n1L n1H n2L n2H.....nL nh OD

Explanation:

The using explanation is same as the command for Printing Curve I.

FS P Print Pre-saved Bitmap

[Format] ASCII: FS P n  
Decimal: 28 80 n  
Hex: 1C 50 n

Explanation:

$0 \leq n \leq 2$ , this command is used to print the monochrome bitmap which is pre-saved in the Flash memory of printer. The bitmap in Flash memory can be created and wrote into printer through Setting Tool in PC. The largest width of bitmap is 384dots and the largest height is 1365dots. (The bitmap can't be over 64km.) "n" is the number of bitmap.

Remark: If the number of bitmap isn't defined, this command is invalid.

The bitmap must be monochrome.

This command won't be affected by printing mode (underline, character size or reverse white printing).

If the width of printed bitmap is beyond one line, the beyond part won't be printed out.

It needs the special setting tool to download the bitmap. Pls ref. (RMDIID Setting Tool). The downloaded bitmap through this method won't be low, unless it is covered by other bitmap.

ESC t Choose Codepage

Format: ASCII: ESC t n  
Decimal: 27 116 n  
Hexadecimal: 1B 74 n

Explanation:

$0 \leq n \leq 45$ , when n is 0xFE, cancel choosing codepage. The character will be printed out according to Codepage Table in Appendix 2. Default n=0xFE, which means no codepage is choosed.

Choose codepage on n page from the following Codepage Table. The value of n is in decimal format.

n	代码页	Code Page
0	CP437 [美国, 欧洲标准]	CP437 [U.S.A., Standard Europe]
1	KataKana [片假名]	Katakana



2	PC850 [多语言]	PC850 [Multilingual]
3	PC860 [葡萄牙]	PC860 [interfaceuguese]
4	PC863 [加拿大-法语]	PC863 [Canadian-French]
5	PC865 [北欧]	PC865 [Nordic]
6	WCP1251 [斯拉夫语]	WCP1251 [Cyrillic]
7	CP866 斯拉夫 2	CP866 Cyrilliec #2
8	MIK[斯拉夫/保加利亚]	MIK[Cyrillic /Bulgarian]
9	CP755 [东欧, 拉脱维亚 2]	CP755 [East Europe, Latvian 2]
10	[伊朗, 波斯]	Iran
11	保留	reserve
12	保留	reserve
13	保留	reserve
14	保留	reserve
15	CP862 [希伯来]	CP862 [Hebrew]
16	WCP1252 [拉丁语 1]	WCP1252 Latin I
17	WCP1253 [希腊]	WCP1253 [Greek]
18	CP852 [拉丁语 2]	CP852 [Latina 2]
19	CP858 [多种语言拉丁语 1+ 欧元符]	CP858 Multilingual Latin I +Euro)
20	伊朗 II [波斯语]	Iran II
21	拉脱维亚	Latvian
22	CP864 [阿拉伯语]	CP864 [Arabic]
23	ISO-8859-1 [西欧]	ISO-8859-1 [West Europe]
24	CP737 [希腊]	CP737 [Greek]
25	WCP1257 [波罗的海]	WCP1257 [Baltic]
26	泰文 ( 与 TM-88 Thai character code 14 同)	Thai
27	CP720[阿拉伯语]	CP720[Arabic]
28	CP855	CP855
29	CP857[土耳其语]	CP857[Turkish]
30	WCP1250[中欧]	WCP1250[Central Eurpoe]
31	CP775	CP775
32	WCP1254[土耳其语]	WCP1254[Turkish]
33	WCP1255[希伯来语]	WCP1255[Hebrew]
34	WCP1256[阿拉伯语]	WCP1256[Arabic]
35	WCP1258[越南语]	WCP1258[Vietnam]
36	ISO-8859-2[拉丁语 2]	ISO-8859-2[Latin 2]
37	ISO-8859-3[拉丁语 3]	ISO-8859-3[Latin 3]
38	ISO-8859-4[波罗的语]	ISO-8859-4[Baltic]
39	ISO-8859-5[斯拉夫语]	ISO-8859-5[Cyrillic]
40	ISO-8859-6[阿拉伯语]	ISO-8859-6[Arabic]
41	ISO-8859-7[希腊语]	ISO-8859-7[Greek]

42	ISO-8859-8[希伯来语]	ISO-8859-8[Hebrew]
43	ISO-8859-9[土耳其语]	ISO-8859-9[Turkish]
44	ISO-8859-15[拉丁语 9]	ISO-8859-15 [Latin 3]
45	[泰文 2]	Thai2

## 4.2.6 Initialization Commands

<u>ESC @</u>	<u>Initialize Printer</u>
Format: ASCII: ESC @	
Decimal: 27 64	
Hexadecimal: 1B 40	

Explanation:

This command is to initialize the following contents of the printer:

- Clear the data in the print buffer;
- Restore the default;
- Delete user-defined characters.

## 4.2.7 Data Control Commands

<u>CR</u>	<u>Carriage Return</u>
Format: ASCII: CR	
Decimal: 13	
Hexadecimal: 0D	

Explanation:

When the "CR" command is sent to printer, all data in the print buffer will be printed out and paper will be fed one line.

<u>NUL :</u>	<u>NUL</u>
Format: ASCII: NUL	
Decimal: 0	
Hexadecimal: 00	

Explanation:

NUL command is used as the final code in some commands such as ESC B, ESC D, ESC% and ECS ', to denote these commands are over. NUL command is ignored when used alone.

## 4.2.8 Chinese Character Print Commands

The command to print Chinese character is FS standard command. All Level I&II Chinese characters and graphics, etc in 16dots&24dots Chinese character library are according to Chinese National Standard GB2312-80. For 24dots, there are only graphics, symbols, etc I A1 and A9 zone are 24dots. Each Chinese character has two bytes. Big5 characters with 16dots are in Traditional Chinese characters library.

The following is the detailed of Chinese Character Print Commands:

FS &		Select Chinese Print Mode	
Format:	ASCII:	FS	&
	Decimal:	28	38
	Hexadecimal:	1C	26

Explanation:

After printer received this command, it will switch from ASCII character print mode to Chinese character print mode. Using GB Chinese Character Library I&II.

Notice: This command is used to switch printer into Chinese Mode when printer is in normal printing mode, but won't be saved after power off. Only after setting through Setting Tool, the result can be saved.

FS .		Cancel Chinese Print Mode	
Format:	ASCII:	FS	.
	Decimal:	28	46
	Hexadecimal:	1C	2E

Explanation:

After printer received this command, it will switch from Chinese character print mode to ANK characters print mode.

Notice: This command is used to switch printer into ANK characters print mode when printer is in normal printing mode, but won't be saved after power off. Only after setting through Setting Tool, the result can be saved.

FS SO		Set Chinese Double Width Print	
Format:	ASCII:	FS	SO
	Decimal:	28	14
	Hexadecimal:	1C	0E

Explanation:

Characters following this command are printed at twice their normal width, does not enlarge the height.

Notice: this command is valid only in one line.

FS DC4 Cancel Chinese Double Width Print

Format:	ASCII:	FS	DC4	
	Decimal:	28	20	
	Hexadecimal:	1C	14	Explanation:

This command is to cancel FS SO command.

FS W Set the Enlarging Multiple of Chinese Character

Format:	ASCII:	FS	W	n	
	Decimal:	28	87	n	
	Hexadecimal:	1C	57	n	Explanation:

Characters following this command are printed at n times of their normal width and height,  
n=1~8

FS J Set Vertical Print

Format:	ASCII:	FS	J
	Decimal:	28	74
	Hexadecimal:	1C	4A

Explanation:

This command is to print Chinese characters vertically, which is that to print characters by rotating 90° at anticlockwise direction.

FS K Set Horizontal Print

Format:	ASCII:	FS	K
	Decimal:	28	75
	Hexadecimal:	1C	4B

Explanation:

This command is to print Chinese characters horizontally, if have not set rotation, the Chinese characters will be printed horizontally, that is normal print status.

FS I Set Chinese Character Rotational Print

Format:	ASCII:	FS	I	n
	Decimal:	28	73	n
	Hexadecimal:	1C	49	n

Explanation:

This command is to rotate Chinese characters, the values of n are as following (Default is 180°):

n	Characters rotated at anticlockwise direction
0	0°
1	90°
2	180°
3	270°
other	invalid

FS - Chinese Character with Underline Print

Format:	ASCII:	FS	-	n
	Decimal:	28	45	n
	Hexadecimal:	1C	2D	n

Explanation:

The specified Chinese characters after this command are printed with underline. When LSB n=1, underline selected; when LSB n=0, it canceled.

Remark: Only LSB of n is valid. Default n=0. This command is valid for both characters and Chinese.

FS + Chinese Character with Up-line Print

Format:	ASCII:	FS	+	n
	Decimal:	28	43	n
	Hexadecimal:	1C	2B	n

Explanation:

The specified Chinese characters after this command are printed with up-line. When LSB n=1, up-line selected; when LSB n=0, it canceled.

Remark: Only LSB of n is valid. Default n=0. This command is valid for both characters and Chinese.

ESC “ Hex Mode Print

Format:	ASCII:	ESC	“	n
	Decimal:	27	34	n
	Hexadecimal:	1B	22	n

Explanation:

When LSB n=0, cancel hex mode print; when LSB n=1, hex mode print is valid.  
 When in hex mode print, all the commands and data the host sent to the printer will be printed in hex codes.  
 Hex mode print will be carried out only when the print buffer is full.  
 Notice: only LSB of n is valid, default n=0

## 4.2.9 Real-time Commands

<u>DLE EOT n</u>		<u>Real-time status transmission</u>		
Format:	ASCII:	DLE	EOT	n
	Decimal:	16	4	n
	Hexdecimal:	10	04	n

Explanation:

Transmits the selected printer status specified by n in real-time, according to the following parameters:

n = 1: Transmit printer status

n = 2: Transmit off-line status

n = 3: Transmit error status

n = 4: Transmit paper sensor status

- The printer returns the related status at once upon receiving it.
- This command should not be used within the data sequence of another command that consists of 2 or more bytes.
- The printer transmits the current status. Each status is represented by one byte data.
- The printer transmits the status without confirming whether the host computer can receive data.
- The printer executes this command at once upon receiving it.
- This command is valid only for serial interface printer. The printer will execute this command at once after receiving it, no matter what status the printer is in.

n = 1: Printer status

Bit	0/1	HEX	Decimal	Function
0	0	0	0	Fixed to 0
1	1	2	2	Fixed to 1
2	0	0	0	Fixed to 0
3	0	0	0	On-line
	1	8	8	Off-line
4	1	10	16	Fixed to 1
5,6	-	-	-	Undefined
7	0	0	0	Fixed to 0

n=2: Off-line status

Bit	0/1	HEX	Decimal	Function
0	0	0	0	Fixed to 0
1	1	2	2	Fixed to 1
2	0	0	0	Fixed to 0
3	0	0	0	Non-pressing paper FEED button
	1	8	8	Pressing paper FEED button
4	1	10	16	Fixed to 1
5	0	0	0	Paper exists
	1	20	32	Paper lack
6	0	0	0	No error status
	1	40	64	Error status
7	0	0	0	Fixed to 0

n = 3: Error status

Bit	0/1	HEX	Decimal	Function
0	0	0	0	Fixed to 0
1	1	2	2	Fixed to 1
2	-	-	-	Undefined
3	0	0	0	Fixed to 0
4	1	10	16	Fixed to 1
5	0	0	0	Fixed to 0
6	0	0	0	Printing head with normal temperature
	1	40	64	Printing head with over-heat temperature
7	0	0	0	Fixed to 0

n=4: paper feeding status

Bit	1/0	HEX	Decimal	Function
0	0	0	0	Fixed to 0
1	1	2	2	Fixed to 1
2,3	0	0	0	Fixed to 0
4	1	10	16	Fixed to 1
5,6	0	0	0	Paper exits
	1	60	96	Paper lack
7	0	0	0	Fixed to 0

## 4.2.10 Bar Code Printing Commands

GS k m d1...dk NUL

Print Barcode

---

Format:	①ASCII:	GS	k	m	d1...dk	NUL
	Decimal:	29	107	m	d1...dk	0
	Hexadecimal:	1D	6B	m	d1...dk	00
	②ASCII:	GS	k	m	n	d1... dn
	Decimal:	29	107	m	n	d1... dn
	Hexadecimal:	1D	6B	m	n	d1... dn

---

Explanation:

①  $0 \leq m \leq 6$  (the value range of k&d is decided by the barcode type)

②  $65 \leq m \leq 73$  (the value range of k&d is decided by the barcode type)

Remark: If the width of barcode is beyond the effective printing width, no characters can be printed, but paper feeds.

m is used to choose the barcode type, showed as below:

m	Barcode type	Character number	d
①	0	UPC-A	$11 \leq k \leq 12$ $48 \leq d \leq 57$
	1	UPC-E	$11 \leq k \leq 12$ $48 \leq d \leq 57$
	2	JAN13 (EAN13)	$12 \leq k \leq 13$ $48 \leq d \leq 57$
	3	JAN 8 (EAN8)	$7 \leq k \leq 8$ $48 \leq d \leq 57$
	4	CODE39	$1 \leq k \leq 255$ $45 \leq d \leq 57, 65 \leq d \leq 90, 32, 36, 37, 43$
	5	ITF	$1 \leq k \leq 255$ $48 \leq d \leq 57$
②	6	CODABAR	$1 \leq k \leq 255$ $48 \leq d \leq 57, 65 \leq d \leq 68, 36, 43, 45, 46, 47, 58$
	65	UPC-A	$11 \leq n \leq 12$ $48 \leq d \leq 57$
	66	UPC-E	$11 \leq n \leq 12$ $48 \leq d \leq 57$



67	JAN13 (EAN13)	$12 \leq n \leq 13$	$48 \leq d \leq 57$
68	JAN 8 (EAN8)	$7 \leq n \leq 8$	$48 \leq d \leq 57$
69	CODE39	$1 \leq n \leq 255$	$45 \leq d \leq 57, 65 \leq d \leq 90, 32, 36, 37, 43$ $d1 = dk = 42$
70	ITF	$1 \leq n \leq 255$	$48 \leq d \leq 57$
71	CODABAR	$1 \leq n \leq 255$	$48 \leq d \leq 57, 65 \leq d \leq 68, 36, 43, 45, 46, 47, 58$
72	CODE93	$1 \leq n \leq 255$	$0 \leq d \leq 127$
73	CODE128	$2 \leq n \leq 255$	$0 \leq d \leq 127$

Explanation for command ①:

Character NUL is added at the last to mean that this command is over.

When UPC-A or UPC-E is chosen, after 12bytes barcode data is received, the other characters will be managed as the common characters.

When JAN13 (EAN13) is chosen, after 13bytes barcode data is received, the other characters will be managed as the common characters.

When JAN8 (EAN8) is chosen, after 8bytes barcode data is received, the other characters will be deal with as the common characters.

The numbers of ITF code data must be even number. If odd numbers of barcode data is input, the last one will be ignored.

Explanation for command ②:

n is used to denote the number of barcode data. Printer will deal with the last n bytes data as the barcode data.

If n is beyond the specified range, the printer will not deal with this command and just deal with the data as the common data.

Explanation:

- If barcode data d is beyond the specified range, this command is invalid.
- If the barcode is beyond printing zone at horizontal direction, invalid.
- No matter how much the line height is set by command ESC 1 n, paper feeding length will be same with the barcode height.
- This command is valid only that there is no data in the printing buffer. If there is data in printing buffer, this command will be ignored.
- After printing barcode, the printing position will be set on the first line.
- This command won't be affected by Print Mode Setting (such as bold printing, duplicate printing, underline, character size, reverse white printing, etc), but will be affected by Invert Printing.

When CODE93 ( m = 72) is choose:

When printer print HRI character, (■+one alphabet character) is used as one control character (<00>H to <1F>H and <7F>H).

Conversion form between control character and HRI character is as below,

Control character			HRI character	Control character			HRI character
ASCII	Hex	Decimal		ASCII	Hex	Decimal	
NUL	00	0	■ U	DLE	10	16	■ P
SOH	01	1	■ A	DC1	11	17	■ Q
STX	02	2	■ B	DC2	12	18	■ R
ETX	03	3	■ C	DC3	13	19	■ S
EOT	04	4	■ D	DC4	14	20	■ T
ENQ	05	5	■ E	NAK	15	21	■ U
ACK	06	6	■ F	SYN	16	22	■ V
BEL	07	7	■ G	ETB	17	23	■ W
BS	08	8	■ H	CAN	18	24	■ X
HT	09	9	■ I	EM	19	25	■ Y
LF	0A	10	■ J	SUB	1A	26	■ Z
VT	0B	11	■ K	ESC	1B	27	■ A
FF	0C	12	■ L	FS	1C	28	■ B
CR	0D	13	■ M	GS	1D	29	■ C
SO	0E	14	■ N	RS	1E	30	■ D
SI	0F	15	■ O	US	1F	31	■ E
				DEL	7F	127	■ T

When CODE128 ( m = 73) is choose:

- Pls refer to Appendix 5 – Related information and characters set of CODE128.
- When CODE128 is used, pls encode according to the below structions:
  1. Do choose characters set (one of CODE A, CODE B and CODE C) before the barcode data.
  2. Choosing characters set is finished through sending character “{” to combine with the other character; ASCII character “{” is finished by sending character “{” twice.

Specified Characters Set	Sending Data		
	ASCII	Hex	Decimal
SHIFT	{S	7B, 53	123, 83
CODE A	{A	7B, 41	123, 65
CODE B	{B	7B, 42	123, 66
CODE C	{C	7B, 43	123, 67
FNC1	{1	7B, 31	123, 49
FNC2	{2	7B, 32	123, 50
FNC3	{3	7B, 33	123, 51
FNC4	{4	7B, 34	123, 52
"{"	{{	7B, 7B	123, 123

[Example] : Printing “No. 123456”

In this example, printer will print “No.” by CODE B, and print the other numbers by CODE C:

GS k 73 10 123 66 78 111 46 123 67 12 34 56



- If it is not the choosing of characters set at the beginning of barcode data, the printer will stop dealing with this command and deal with the other data as the common data.
- If the combination by “{” and that following character is not in the above form, the printer will stop dealing with this command and deal with the other data as the common data.
- If the character received by printer is not barcode characters set data, the printer will stop dealing with this command and deal with the other data as the common data.
- When printer prints HRI characters, it doesn't print shift character and choosing data in characters set.
- Function characters in HRI character won't be printed.
- Control characters(<00>H to <1F>H and <7F>H)in HRI character won't be printed.

Pls be sure the space at both left and right side of barcode. The space will be different according to the different barcode.

Pls refer to GS H, GS h, GS w, Appendix 5.

GS H n		Choose printing position of HRI character		
Format:	ASCII:	GS	H	n
	Decimal:	29	72	n
	Hexadecimal:	1D	48	n

Explanation:  $0 \leq n \leq 3$ ,  $48 \leq n \leq 51$ . When printing barcode, choosing printing position for HRI characters.

n can appoint the printing position of HRI:

n	Printing position
0, 48	Don't print
1, 49	Above barcode
2, 50	Below barcode
3, 51	Both above and below barcode

HRI is note character for barcode content. Default value: n=0.

Pls refer to GS k

Remark: if n is in other value, it is invalid.

GS h n		Set Bar code Height		
Format:	ASCII:	GS	h	n
	Decimal:	29	104	n
	Hexadecimal:	1D	68	n

Explanation: Set the height of printed bar code. n=0~255, unit is dot. If n=0, it is 256dots. Default value n=60.

GS	w	n	Set Bar code Width		
Format :	ASCII :	GS	w	n	
	Decimal:	29	119	n	
	Hexadecimal:	1D	77	n	

Explanation:  $2 \leq n \leq 6$ (the other value of n is invalid). Set the horizontal module width of barcode. The detail is as below,

n	Width of single basic module (mm)	Width of double basic module		
		Narrow module (mm)	basic Wide module(mm)	basic
2	0.25	0.25	0.625	
3	0.375	0.375	0.875	
4	0.5	0.5	1.25	
5	0.625	0.625	1.625	
6	0.75	0.75	1.875	

Single basic module barcode: UPC-A, UPC-E, JAN13 (EAN13), JAN8 (EAN8), CODE93, CODE128

Double basic module bar code: CODE39, ITF, CODABAR

Default value:  $n = 3$ . Pls refer to GS k.

## Chapter 5 Using and Maintenance

### 5.1 Printing Head Maintenance

In order to guarantee the normal work of the printer, pls notice that do not disassemble the printing head. If the outer case of printer is not used, pls pay more attention to protect the printing head.

1. If you do not use the printer for a long time, please don't put through the printer on the power.
2. If the printer works abnormally, please turn off the printer power.
3. The used power must meet the requirements, otherwise it will be disadvantageous for the print head.
4. While changing the paper roll, please notice whether there is paper scrap on the print head. If so, please blow gently.
5. Keep the circuit board of the printer clean and dustless.
6. When the thermal printer can't print clearly, the printing head can be wiped by alcohol cotton ball.

### 5.2 Other

Please also notice the following aspects:

1. Don't insert and pull out the chip. If there is abnormality, please hand over to the producer for repairing.
2. When you suppress to join the electric wire by yourself, pls do pay attention to the interface of printer - parallel interface or serial interface, to avoid the wrong connection with the host computer.

## Chapter 6 Printer Using under Windows

The version of printer's driver software is SP-DRV211. The manual for driver software and installation can be downloaded from our website. Do not introduce the details here.

Remark: During installing driver, choose the printer model "58 thermal series". The other details can be checked from Installation Manual.

### Appendix1 Valid Codes Form under ANK printing

The serial numbers of valid codes are from 00H to 0FFH, among which 00H-1FH are control codes and 20H-0FFH are character codes. Character codes are composed by two characters sets. The character codes of each character set are all in 20H-0FFH permutation.

Characters Set 1:

	0	1	2	3	4	5	6	7	8	9	A	B	C	D	E	F
2		!	"	#	\$	%	&	'	(	)	*	+	,	-	.	/
3	0	1	2	3	4	5	6	7	8	9	:	;	<	=	>	?
4	@	A	B	C	D	E	F	G	H	I	J	K	L	M	N	O
5	P	Q	R	S	T	U	V	W	X	Y	Z	[	\	]	†	—
6	ˆ	a	b	c	d	e	f	g	h	i	j	k	l	m	n	o
7	p	q	r	s	t	u	v	w	x	y	z	{		}	~	
8	0	一	二	三	四	五	六	七	八	九	十	元	年	月	日	¥
9	£	§	↓	→	∧	±	÷	∞	□	...	o	□	²	³	₂	₃
A	α	β	γ	δ	ε	ζ	η	θ	λ	μ	ν	Ω	ξ	π	ρ	σ
B	τ	Φ	ψ	ω	Γ	∠	Π	Σ	Ψ	Ω	Ξ	Θ	Λ	φ	Υ	∠
C	⌈	⌋	⌈	⌋	ˉ	—			/	\	┌	└	┌	└	□	×
D	⌈	⌋	⌈	⌋	ˉ	—			/	\	┌	└	┌	└	┌	└
E	┌	└	┌	└	┌	└	┌	└	┌	└	┌	└	┌	└	┌	└
F	▪	▪	▪	▪	▪	▪	▪	▪	▪	▪	▪	▪	▪	▪	▪	+

Characters Set 2:

	0	1	2	3	4	5	6	7	8	9	A	B	C	D	E	F
2	百	千	万	Π	℃	ℱ	- <sup>1</sup>	4	<sub>4</sub>	½	⅓	¼	∓	×	√	⊥
3	//		∩	∪	⊗	⊃	⊆	≠	∇	∇	∂	∫	∫	∅	∴	
4	∴	=	≡	≈	≠	∞	≤	≥	≪	≫	δ	♀	♂	†	%	∴
5	※	□	( )	《 》	『 』	【 】	~	∞	○	♥	♦	♣				
6	♠	ア	イ	ウ	エ	オ	カ	キ	ク	ケ	コ	サ	シ	ス	セ	ソ
7	タ	チ	ツ	テ	ト	ナ	ニ	ヌ	ネ	ノ	ハ	ヒ	フ	ヘ	ホ	マ
8	ミ	ム	メ	モ	ㇿ	⊥	ヨ	ラ	リ	ル	レ	ロ	ワ	キ	エ	フ
9	ン	ァ	ゥ	ェ	ォ	カ	ユ	ヰ	ヱ	ㇿ	○	Б	Д	Е	Ж	З
A	И	Й	Л	Ц	Ч	Ш	Щ	Ъ	Ы	Э	Ю	Я	б	с	е	о
B	о	г	и	е	á	ä	á	ã	Š	e	ë	è	í	î	ï	Ä
C	Ä	É	æ	Æ	Ô	Ó	Ô	Û	Û	ÿ	Ö	Ü	⋈	℞	f	ó
D	í	ó	ù	ñ	Ñ	á	ó	ì	ó	ù	é	á	ä	á	ã	Š
E	è	ë	è	í	î	ï	Ä	Á	É	æ	Æ	Ô	Ó	Ô	Û	Û
F	ÿ	Ö	Ü	⋈	℞	f	ó	í	ó	ù	ñ	Ñ	á	ó	ì	ó



## Appendix2 Valid Codes Form under Chinese printing

The serial numbers of valid codes are from 00H to 0FFH under Chinese printing, among which 00H-1FH are control codes and 20H-0FFH are character codes.

HEX	0	1	2	3	4	5	6	7	8	9	A	B	C	D	E	F
2		!	”	#	\$	%	&	'	(	)	*	+	,	-	.	/
3	0	1	2	3	4	5	6	7	8	9	:	:	<	=	>	?
4	@	A	B	C	D	E	F	G	H	I	J	K	L	M	N	O
5	P	Q	R	S	T	U	V	W	X	Y	Z	[	\	]	^	_
6	`	a	b	c	d	e	f	g	h	i	j	k	l	m	n	o
7	p	q	r	s	t	u	v	w	x	y	z	{		}	~	
8	€	ü	é	â	ä	à	å	ç	ê	ë	è	ï	î	ì	Ä	Å
9	É	Æ	FE	ô	ö	ò	û	ù	ÿ	Ö	Ü	¢	£	¥	ℜ	f
A	á	í	ó	ú	ñ	Ñ	ª	º	¿	Γ	γ	½	¼	ı	《	》
B	⌘	⌘	⌘		†	‡	‡	π	¶	‡		¶	¶	¶	¶	¶
C	L	⊥	⊥	†	—	†	‡	‡	ℒ	ℒ	⊥	⊥	‡	=	‡	⊥
D	⊥	⊥	π	ℒ	ℒ	F	π	‡	‡	J	Γ	■	■	■	■	■
E	α	β	Γ	π	Σ	σ	μ	τ	Φ	θ	Ω	δ	∞	φ	∈	∩
F	≡	±	≥	≤	∫	J	÷	≈	°	•	-	√	n	2	■	

## Appendix3 Printing Commands Form

Decimal	Hexadecimal	Symbol&Format	Function	Page
0	0	NUL	Ending Mark	32
9	9	HT	Perform horizontal tab	19
10	0A	LF	Linefeed	16
11	0B	VT	Perform vertical tab	18
13	0D	CR	Carriage Return	32
16 4 n	10 04 n	DLE EOT n	Real-time status transmission	35
27 34 n	1B 22 n	ESC “ n	Select/prohibit Hex print	35
27 37 n	1B 25 n	ESC % m1 n1.....mk nk 00	Replace User-defined Character	27
27 38	1B 26	ESC & m n1 n2..... n6	User Define Character	26
27 39	1B 27	ESC ‘ m .....nIL nIH CR	Print M Curve dots (dashed)	29
27 43 n	1B 2B n	ESC + n	Select/prohibit Up-line Print	24
27 44	1B 2C	ESC , m .....nIL nIH CR	Print M Curve dots (full line)	29
27 45 n	1B 2D n	ESC - n	Select/cancel Underline Print	23
27 49 n	1B 31 n	ESC 1 n	Set n Dot-line Spacing	17
27 54	1B 36	ESC 6	Choose Characters Set 1	26
27 55	1B 37	ESC 7	Choose Characters Set 2	26
27 58	1B 3A	ESC :	Recover Character in Character Set	27
27 64	1B 40	ESC @	Initialize Printer	31
27 66	1B 42	ESC B n1.....kNUL	Set Vertical Tab Value	17
27 68	1B 44	ESC D n1.....k NUL	Set Horizontal Tab Value	18
27 74 n	1B 4A n	ESC J n	n Dot Line Feed	16
27 75	1B 4B	ESC K n1.....n2...data	Print n×8graphics	28
27 81 n	1B 51 n	ESC Q n	Set Right Margin	21

27 85 n	1B 55 n	ESC U n	Enlarge Width	22
27 86 n	1B 56 n	ESC V n	Enlarge Height	22
27 87 n	1B 57 n	ESC W n	Enlarge Width and Height	23
27 99 n	1B 63 n	ESC C n	Select/prohibit Reverse Print	25
27 102 m n	1B 66 m n	ESC f m n	Print Blank Characters or Lines	19
27 105 n	1B 69 n	ESC i n	Select/prohibit Reverse White Print	25
27 108 n	1B 6C n	ESC l n	Set Left Margin	20
27 112 n	1B 70 n	ESC P n	Set Character Space	21
27 116 n	1B 74 n	ESC t n	Choose Codepage	30
28 14 n	1C 0E n	FS S0 n	Set Chinese Double Width Print	33
28 20	1C 14	FS DC4	Cancel Chinese Double Width Print	33
28 38	1C 26	FS &	Set chinese print	32
28 43 n	1C 2B n	FS + n	Overline Print	35
28 45 n	1C 2D n	FS - n	Underline Print	34
28 46	1C 2E	FS •	Cancel Chinese Print Mode	33
28 73 n	1C 49 n	FS I n	Set Chinese Character Rotational Print	34
28 74	1C 4A	FS J	Set vertical printing	33
28 75	1C 4B	FS K	Set Horizontal Print	34
28 80 n	1C 50 n	FS P n	Set Horizontal Print	29
28 87 n	1C 57 n	FS W n	Print Pre-saved Bitmap	33
29 72 n	1D 48 n	GS H n	Set the Enlarging Multiple of Chinese Character	40
29 104 n	1D 68 n	GS h n	Set Barcode Height	41
29 107 n	1D 6B n	GS k n	Print Barcode	37
29 119 n	1D 77 n	GS w n	Set Barcode Width	41