

SPRT®

SP-EU801 PRINTING UNIT USER'S MANUAL

(SP-EU801)

Version 1.05

Beijing Spirit Technology Development Co.,Ltd

www.sprt-printer.com

Safety Instruction

Safety warning

- 1)The print head is heating parts, during printing and end printing, do not touch the print head and surrounding parts.
- 2)Do not touch the surface of the print head and connection socket, avoid the electrostatic damage the print head.

Notice

- 1) Printing units should be installed in a flat, stable place;
- 2) Keeping enough space around the printing units to be convenient for operation and maintenance;
- 3) Far away from water for all printing units;
- 4) Do not use and store printing units in high temperature, damp and polluted places. Avoid sunlight, strong light and heat direct sources;
- 5) Avoid the printing units in the vibration and impact;
- 6) Avoid the damp air condensation on the surface of the printing units. If condensation has been formed, do not open the power of the printing units before the dew disappear;
- 7) Keep the printing units power adapter connected to a properly grounded outlet; avoid using the same socket with large motor or other devices which can lead to the power supply voltage fluctuation;
- 8) If long time will not use the printing units, please disconnect the power of the power adapter;
- 9) To avoid water or conductive material into the printing units interior, once occurred, should immediately shut off the power;
- 10)Printing units shall not be print under the conditions of no paper , otherwise will seriously damage the printing roller and the thermal print head;
- 11)In order to guarantee the print quality and the product life, suggest to use same quality paper as recommended;
- 12)In the case of print effect meets the requirement, suggest users to set lower level concentration of print as much as possible, to avoid affect the life of the print head;
- 13)The user shall not be removed printing units for maintenance.

Contents

Brief Introduction.....	1
Model Classification.....	1
Chapter 1 Characteristics and performance.....	2
1.1 Print performance.....	2
1.2 Print paper.....	2
1.3 Character set.....	2
1.4 Interface.....	2
1.5 Printing control command.....	3
1.6 Power supply.....	3
1.7 Installation Dimension.....	3
Chapter 2 Operating instructions.....	4
2.1 Printing Unit components.....	4
2.2 Instructions for paper install.....	5
2.2.1 Paper Loading.....	5
2.2.2 Solution for paper jam of cutter.....	5
2.3 Interface connection.....	5
2.3.1 Serial interface connection.....	5
2.3.2 Parallel interface connection.....	6
2.3.3 Power supply connection.....	8
2.4 Lights and buttons operation.....	8
2.5 Normal working mode.....	9
2.6 Self-test.....	10
2.7 HEX Printing mode.....	10
2.8 The printer parameters setting.....	10
2.9 Enter into the program upgrading mode.....	11
2.10 Installation and use notes.....	11
Appendix A: Parameters setting.....	14

Brief Introduction

SP-EU801 printer is a new thermal line panel printer, with drop-in paper easy loading、 auto cutter、 Black label detection、 faster and more reliable.

SP-EU801 printer easy operation , applications widely, especially to queue machine、 POS for bank and the business of all kinds of needed docs to print.

Statement

This product is belong to class A. In the living environment, this product may cause radio interference. In that case, the user need to take practical measures to interference.

Model Classification

Model	Interface	Holder(Yes or No)	Remark
SP-EU801SU	RS-232C serial and USB	Yes	Large cache available
SP-EU801P	Parallel	Yes	large cache available

Chapter 1 Characteristics and performance

1.1 Print performance

- Printing method: direct line thermal;
- Printing paper width: 79.5 ± 0.5 mm
- Resolution: 8 dots/mm, 576 dots/line
- Printing speed: 220 mm / s (max)
- MCBF: (1) Printing head life: 100 km
Operating conditions:
 - * Print font 12 × 24 ASCII, 50 lines per, Intermittent repeat print.
 - * Thermal paper(2) Auto cutter life: 1,000,000 cuts.
- Effective printing width: 72 mm

1.2 Print paper

- The mode of thermal paper: TF50KS—E (Japan paper co. Ltd)
AF50KS-E (JUJO THERMAL)
- Thermal paper roll: width ----- 79.5 ± 0.5 mm
thickness ----- 0.06 mm ~ 0.08 mm
roll inside ----- $\Phi 14$ mm
Paper Type ----- $79.5 \times \Phi 120$ mm (MAX)

1.3 Character set

- ANK character set:
 - 12 × 24 dot, 1.5 (width) × 3.00 (high) mm
 - 8 × 16 dot, 1.0 (width) × 2.00 (high) mm
- Chinese:
 - 24 × 24 dot, 3.00 (width) × 3.00 (high) mm
 - 16 × 16 dot, 2.00 (width) × 2.00 (high) mm

1.4 Interface

- RS—232C serial port:
 - DB-9 socket (pin point), support XON/XOFF and DTR/DSR.
 - Baud rate: 1200, 2400, 4800, 9600, 19200, 38400, 57600, 115200 bps adjustable.
 - Data structure: One start bit + (7 or 8) data + one stop bit.
 - Verify: No validation or odd and even check is optional.

- Parallel port:
36pin, 8 bits parallel, BUSY/ACK handshaking protocol agreement, TTL.
- USB port:
Standard USB port.

1.5 Printing control command

- Characters print command:support the double width and height printing of ANK characters 、 self-defined characters and Chinese; characters lines spacing can be adjusted.
- Bitmap print command:Support printing bitmaps with different density and downloaded graphics.
- GS bar code print command :support UPC-A、UPC-E、EAN-13、EAN-8、CODE39、ITF25、CODABAR、CODE93、CODE128、PDF417、QR Code、DATA Matrix bar code print.

1.6 Power supply

- DC24V±10%， 2A， VH3.96-4P power socket

1.7 Installation Dimension

- Outline dimension: 202mm×162mm×135mm(L*W*H)
- Detail dimension as below figure 1-1:

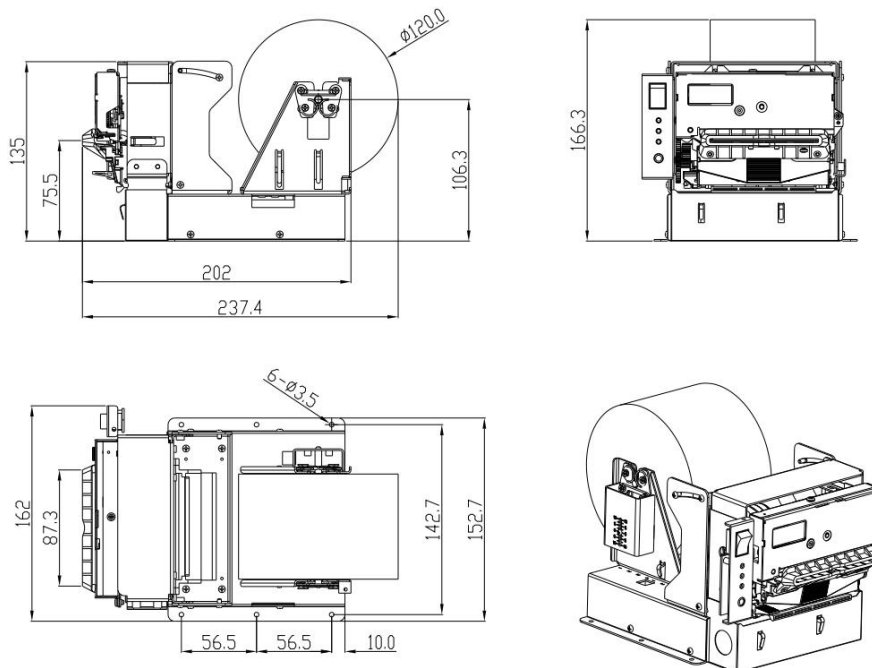

FIG.1-1 SP-EU801 dimensions

1.8 Working environment

- operating temperature :0~50℃
- storage temperature :-20~60℃
- relative humidity:10%~80%
- Storage relative humidity:10%~90%

Chapter 2 Operating instructions

2.1 Printing Unit components

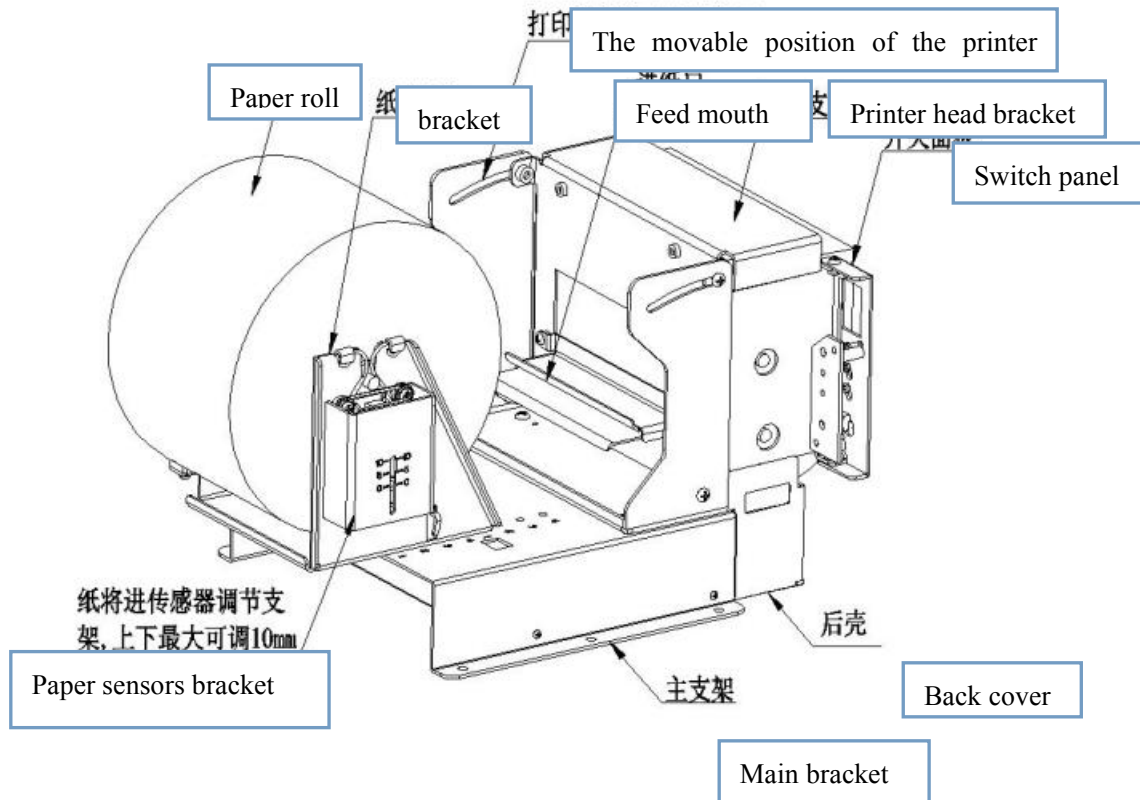



FIG.2 SP-EU801 unit components

2.2 Instructions for paper install

2.2.1 Paper Loading

Thermal paper installed as below:

In the state of power-on, pull out a little from the paper roll, then put the paper into the mouth of printing mechanism, the printer will auto paper feeding

 **Attention**

1. Pay attention to in the direction of the paper roll, keep the print surface towards the head.
2. Please do not move the paper forward or back by hands.
3. Keep clean for the printer head or will effect the quality of the Printing

2.2.2 Solution for paper jam of cutter

If the cutter is jammed, turn off the power and turn on the printer again, the cutter will recover. If the paper is jammed, please open the rubber roll and take out the paper. If the cutter does not recover after reset, you can move the plastic gears on the cutter to recover the cutter.

If you want to keep the data when the cutter is jammed, please do not turn off the power and use the manual method to recover the cutter. Then open the rubber roll and take out the jammed paper, now turn off the rubber roll. The printer will recover from the paper cutting errors.

2.3 Interface connection

2.3.1 Serial interface connection

SP-EU801 printer serial interface is compatible with RS-232C , support DTR/DSR and XON/XOFF handshaking protocol. Its interface is DB-9 pin type socket outlet. The pin number of serial interface socket as shown in figure 2-5:

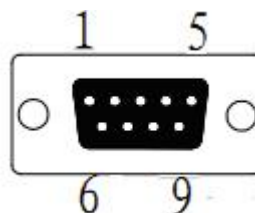

Each pin signal is defined as shown in figure 2-5:

Pin No.	Signal name	Signal direction	Source	Explain
1	NC	----	----	
2	RXD	input	Host	Printer receive data from computer
3	TXD	output	printer	Printer send control code XON/XOFF and data to computer.
4	DTR	output	printer	When the signal show "MARK", it is means the printer is busy and can not receive data, when the signal show "SPACE", it is mean the printer get ready and can receive data.
5	GND	----	----	Signal ground
6	DSR	input	host	When the signal show "MARK", it is means the printer is busy and can not receive data, when the signal show "SPACE", it is mean the printer get ready and can receive data.
7	RTS	output	printer	Same as DTR
8	CTS	input	host	Same as DSR
9	NC	----	----	

Mark: ① "Source" means the place of the signal from
 ② Signal logic level for EIA

The baud rate and data structure have been set as 9600bps/8 data bits/no calibration and 1stop bit under connected as serial. SP-EU801 printer's serial interface can be connected to the standard of RS-232C interface, the right connect way as figure 2-6.

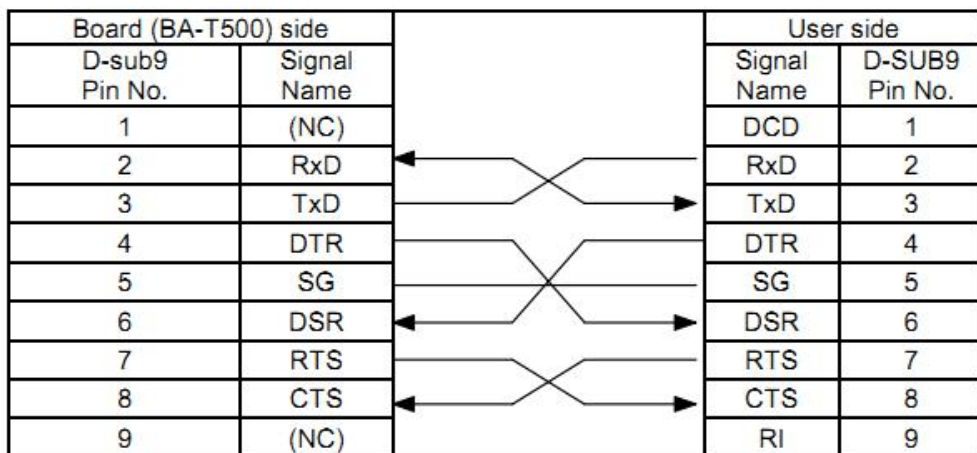

2.3.2 Parallel interface connection

SP-EU801 printer parallel interface is compatible with CENTRONICS, support BUSY or ACK

handshaking protocol, The 36 pin number of parallel interface socket as shown in figure 2-7:

Pin No.	Signal	Signal direction	Explanation
1	STROBE	in	Gated FF, Rising along the read data
2	D1	in	These signals representing one to eight parallel data information, each signal when the logic is "1", it is high level, logic is "0" means low level.
3	D2	in	
4	D3	in	
5	D4	in	
6	D5	in	
7	D6	in	
8	D7	in	
9	D8	in	
10	ACK	out	Pulse reply, when it is low level means the data has been received and prepare to receive next data.
11	Busy	out	High level means it is busy for printer and can not receive data
12	PE	out	High level means paper end sensor
13	SEL	out	The resistance to high level
17	FG	...	Frame GND
18	Logic-H	...	Logic "1" level
32	nFault	out	low level means printer errors
14,15,17,18,34,36	NC	...	No Connect
16,19-30,33	GND	...	Ground, Logic "0" level
35	+5V	...	+5V power supply

Parallel connection interface signal sequence as shown in figure 2-8:

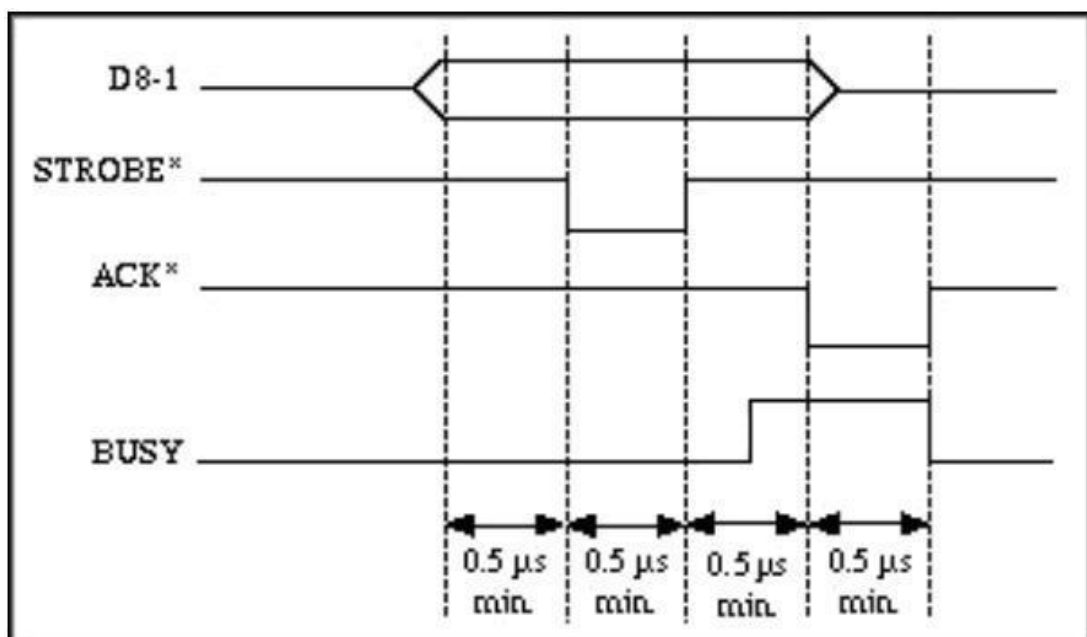

2.3.3 Power supply connection

For SP-EU801 printer, the power supply is external $24V \pm 10\%$ 、2A, socket is VH3.96-4P type, Shape and pin definition as shown in figure 2-9,

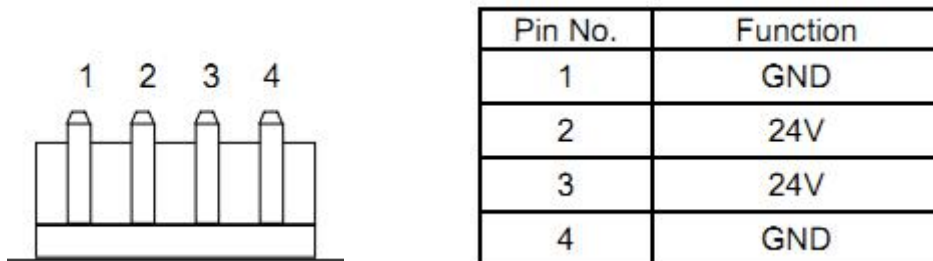

2.4 Lights and buttons operation

SP-EU801 printer has one button and three lights.

【FEED】 is paper feeding button, available to print commands allow or prohibit button switch function, in the condition of allow button control, press 【FEED】 button printer feeding paper, loosen 【FEED】 button, stop feeding paper.

Green power indicator light is for power light. POWER indicator lighting means printer has been switched on .

Red light for PAPER OUT indicator is paper status indicator. When it is light, it means the printer is out of paper.

Red light for the ERROR is Error status indicator, When the print working with normally, the red Error light is off, the light is flashing as abnormal alarm status, if the indicator is long on, means the printing mechanism is opened in the process of printing.

Error light flash: means there are something wrong with printer.

According to blink in a different way, indicate the different types of printer error:

1、 Non-recoverable error, The times of lights flashing said wrong type, then will light for a long time.







2、 Recoverable errors, the times of lights flashing means the error type, then will light-off for a period.

3、 Automatic recovery error, the lights will flash continuous.

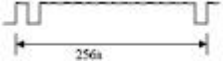
4、 Paper out, lack of light long on paper. When printing on the rubber roller no longer test for a lack of printer paper, only check whether have paper.

Show as below:

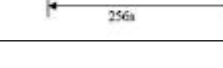
a. Non-recoverable error, the lights will flash for many times later will lighting for a period, then circulation, the times of the lights flashing show the errors type.

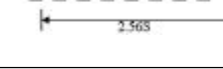
Error type	Error description	ERROR lights flash type
Non-recoverable error	LED flash once:Memory read error	
	LED flash two times:Overvoltage	
	LED flash three times:Under voltage	
	LED flash four times:The CPU execution error (error address)	
	LED flash five times :UIB error	
	LED flash six times:FLASH write error	
	LED flash seven times:Write error parameter	
	LED eight times:Temperature detection circuit error	

b. Recoverable errors, the lights will flash continuous, then light-off for a period.

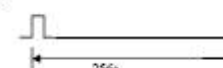
Error type	Error description	ERROR lights flash type
Recoverable errors	LED flash once :cutter position error	

c. Automatic recovery error, the lights will flash continuous. Including the print head temperature error and the upper cover to open the print process error.

Error type	ERROR lights flash type	ERROR lights flash type
Recoverable errors	LED flash continuous: the printer head is overheating, or open the wrong printing mechanism in the process of printing roller.	

2.5 Normal working mode

When printer is off, 【printing rubber roller】 is closed, then open the power button, Status indicators and paper out indicator shine alternately twice and then off, printer enter into the normal working mode.

2.6 Self-test

Self-test can detect the printer is working correctly or not, if it can print out self-test receipt correctly, it is mean everything is normal except the port connection with PCB board, or will be need repaired.

Self-test print out in sequence: name of manufacture、printer mode、software version、interface type、parameter default value of printer's、96 characters in the ASCII code、default code page content(set the language as English)or Chinese character name(if language set as Chinese)、bar code type.

The self-test method is press the button of **【FEED】** to open the power supply, then the printer will print out the self-test receipt.

\

2.7 HEX Printing mode

According to below steps, make the printer enter into the HEX printing mode.

- 1、 Open the rubber roller of printing agencies;
- 2、 Press the button of **【FEED】** to open the power supply;
- 3、 Close the rubber roller printing agencies, then print out the three lines content as below:

Hexadecimal Dump

To terminate hexadecimal dump,
Press FEED button three times.

It is means the printer has enter into HEX printing mode, under this mode all the input content will be printed out as HEX DUMP, the paper will online after press the **【FEED】** button once, totally three times, print out "**** Completed ***", quit HEX DUMP mode.

2.8 The printer parameters setting

This function is to set up some simple parameters for the printer.

Enter into parameter setting method:

In shutdown mode, open the **【printing rubber roller】** first, press the button of **【FEED】**, then open the power supply, after the status indicators and lack of paper lights flashing alternant release the button of **【FEED】**. Press the button of **【FEED】** twice again, then close the **【printing rubber roller】**. The printer enter into parameter setting mode. And print out the first item of parameters and its current value which can be set. The details for setting method reference appendix A.

The method to quit the parameter setting

Open the **【printing rubber roller】** first, press the button of **【FEED】**, then close the **【printing rubber roller】** and release the button of **【FEED】**, save the setting values of the parameters and exit. Enter into the normal working mode.

If the printer's power supply is closed directly, the setting parameters will lose.

2.9 Enter into the program upgrading mode

When printer is off, open the 【printing rubber roller】 first, press the button of 【FEED】 , then open the power supply, after the status indicators and lack of paper lights flashing alternant release the button of 【FEED】 . Press the button of 【FEED】 five times, then close the 【printing rubber roller】 . The printer enter into the program upgrade mode. Then the status indicator light will flash as 1s speed.

Quickly access method: In shutdown mode, open the 【printing rubber roller】 first, press the button of 【FEED】 , then open the power supply, then release the button of 【FEED】 quickly. The printer enter into the program upgrade mode. Then the status indicator light will flash as 1s speed.

Attention: After entering into the program upgrade mode. If the paper out indicator lights, it means the program of this interface can not be upgraded. Serial port 、 parallel and USB port support upgrade online.

2.10 Installation and use notes

1. The connection position of paper exit and equipment paper exit was suggested to be one of the following:

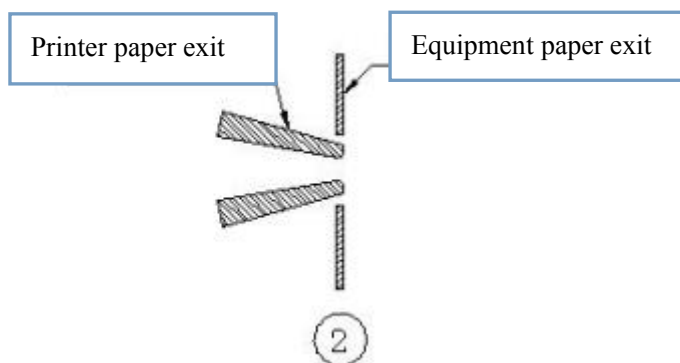
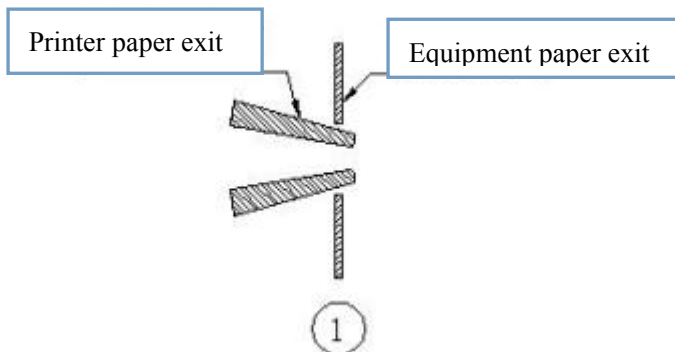

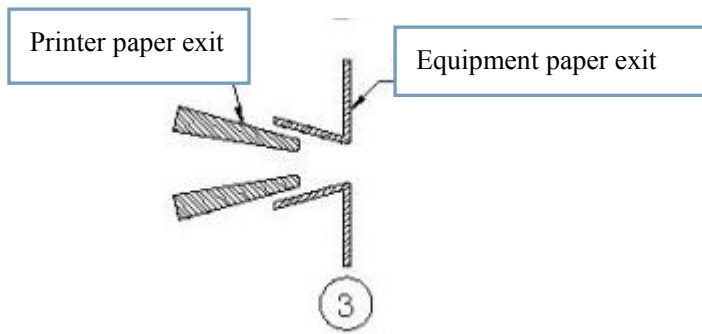

2. When the connection position as the above chart, ① and ②, there must need gaps must be left between the printer's paper exit and equipment's paper exit, see chart below.

Must left gaps between paper exit and equipment(suggest each side:1mm-3mm, as chart A)

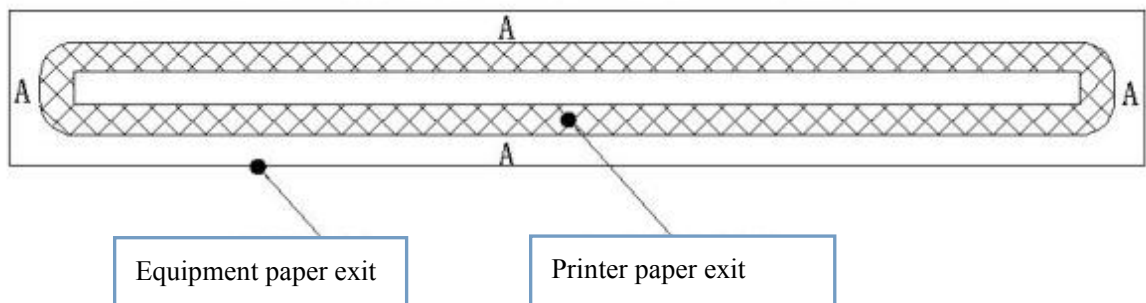

3. Printer must be installed firmly, to prevent paper jam because of external displacement. If installed on the slide rail, it needs to be the sliding rail makes the limit mechanism.

4. Paper bin and bracket need set up separately , paper bin(paper bracket) and paper feed port must be placed in the center, the width of paper(paper bracket) is +1mm, if the paper roll diameter over 80mm, it must add paper buffer construction, chart as below:

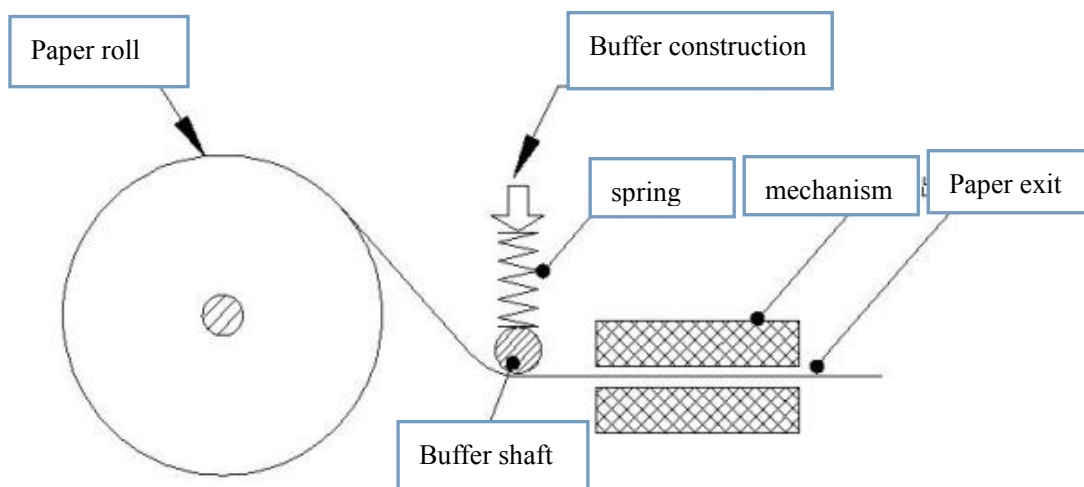

5. In the process of use, it is necessary to wait for the printer to finish cutting paper before

tearing/taking paper, so as to avoid paper blocking and deviation problem caused by paper tearing.

6. In the process of use, do not cover the paper exit with hands, and make sure there is also not have sundries cover, avoid paper jams.

7. Ensure the paper head is flat and free from debris when loading the paper, so as to avoid slanting the paper of getting stuck in the machine head.

8. Printer is not suitable for working in the vibration environment, if using in vibration environment, must add shock absorption design.

9. The printer in the dust, oil, moisture, high temperature and other harsh environment work, effective protection measures must have, so as not to affect the normal use.

10. After the printer roller is turned on and maintained, check whether it is closed collect, when it is closed, and ensure that the buckle is completely locked. See the following figure.

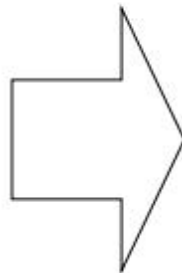

Appendix A: Parameters setting

This appendix shows the way, through which printer's parameters are sett through the button.

Setup instruction: use the button of 【printing rubber roller】 to choose the setting items, change the item by press the button 【printing rubber roller】 , and print out the current value. Use the button of 【FEED】 to set the parameter, the parameter will be changed by press the 【FEED】 button.

Full setting:

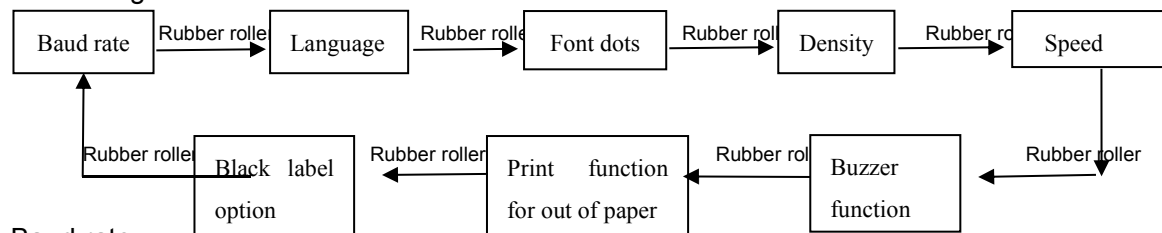

Baud rate:

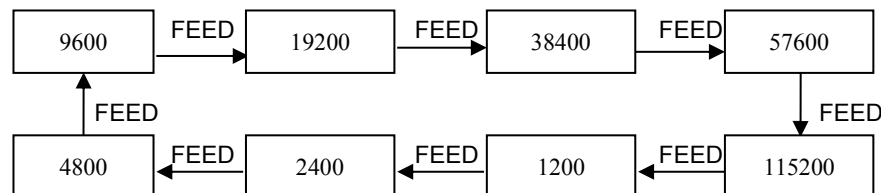

Language:



Font dots:

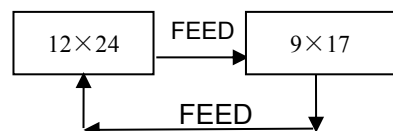

Print density:

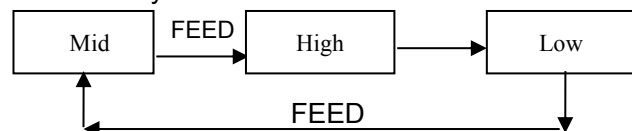

Print speed:

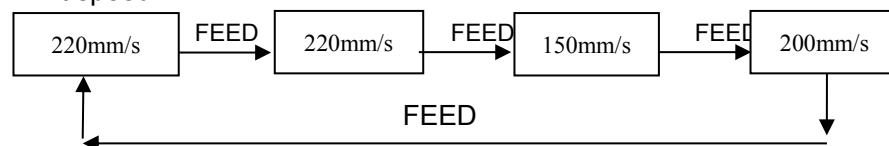

Re-printing lack of paper:

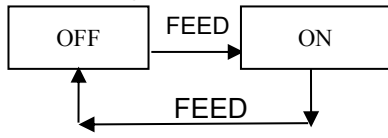

Black label mode:

