

SPRT®

**SP-POS88 V Thermal Receipt
Printer**



User's Manual

(Ver 1.05)

Beijing Spirit Technology Development Co.,Ltd.

www.sprt-printer.com

Content

Introduction.....	1
Chapter 1 Feature and Performance.....	1
1.1 Print Performance.....	1
1.2 Print Paper.....	2
1.3 Print Font.....	2
1.4 Interface.....	3
1.5 Print Control Commands.....	3
1.6 Power Supply.....	4
1.7 Operation Environment.....	4
1.8 Outline Dimension&Weight.....	4
1.9 Model classification.....	4
Chapter 2 Operation Specification.....	6
2.1 Printer Appearance.....	6
2.2 Paper Installation.....	7
2.2.1 Paper Loading.....	7
2.2.2 Solution to Paper Jam.....	7
2.3 Interface.....	8
2.3.1 Serial Interface.....	8
2.3.2 Parallel Interface.....	11
2.3.3 Cash Drawer Interface.....	14
2.3.4 Power Connection.....	15
2.4 Buttons and Indicators.....	15
2.5 Self-test.....	16
2.6 Hexadecimal Printing.....	16
2.7 Parameter Setting.....	17
2.8 Enter the program upgrade mode.....	17
Appendix A.....	18

Introduction

POS88V printer is a new type line thermal printer, it features in fast speed print, low print noise, high reliability, perfect print quality and ribbon needless, avoiding the vexation of regular maintenance.

POS88V printer: small in outline dimension, simple operation, and extensive application, especially suitable for commercial cash register, PC POS, bank POS and all kinds of receipts print.

Warning

This is a class A product. In a domestic environment this product may cause radio interference in which case the user may be required to take adequate measures.

Chapter 1 Feature and Performance

1.1 Print Performance

- Print method: direct thermal
- Print paper width: 79.5±0.5mm
- Print density: 8 dots/mm, 576 dots/line
- Print speed: approx.250mm / sec. (max)
- Reliability

(1)Print head life: 150km

Using condition:

* Print 12 × 24 ASCII characters, print 50 lines each time, intermittent print repeatedly

* Each dot-line printing at the same time should not exceed 25%, each character line and one dot vertical printing repeatedly should not

- exceed 11 times
- * Use specified thermal paper
- (2) Cutter life: 1500,000 cuts

- Valid print width: 72mm

1.2 Print Paper

- Thermal paper roll model: TF50KS—E (Japan paper co.ltd)
AF50KS-E (JUJO THERMAL)
- Thermal paper roll: Paper Type: thermal paper 79.5xφ80mm (max)
Thickness — — — 0.06mm~0.08mm

1.3 Print Font

- ANK Character Set
12×24 dots, 1.5 (W) × 3.00 (H) mm
- GB GB2312-80(Chinese):
24×24 dots, 3.00 (W) × 3.00 (H) mm.

1.4 Interface

- RS—232C Serial Interface:
DB-25 socket (female), supports XON/XOFF and TR/DSR protocols.
Baud-rate: 2400, 4800, 9600, 19200, 38400, 57600, 115200bps adjustable。
Data structure: 1 start bit + (7 or 8) data bits + 1 stop bit.
Parity checking: no parity or odd, even parity optional.
- Parallel Interface
36-pin, 8-bit parallel interface, BUSY/ACK handshaking protocol, TTL signal level.
- Ethernet Interface: Standard Ethernet interface.

- USB Interface:USB interface
- Cash Drawer Control
DC24V,1A,6-pin RJ-11 socket.

1.5 Print Control Commands

- Character print commands: support double-width, double height print of ANK characters, user-defined characters and Chinese characters, the character line spacing is adjustable.
- Graphics print commands: support the print of bit-map graphics and download bit-map graphics with different density
- GS bar code print commands: support UPC-A, UPC-E,EAN-13, EAN-8, CODE39, ITF25, CODABAR, CODE93, CODE128, PDF417, QR bar code print.

1.6 Power Supply

- DC24V \pm 10%,2A,A-1009-3P power socket.

1.7 Operation Environment

- Operation temperature: 0~50°C; Relative humidity: 10~80%
- Storage temperature: -20~60°C; Relative humidity: 10~90%

1.8 Outline Dimension&Weight

- Dimension: 200 (L) mm×150 (W) mm×139 (H) mm
- Weight: 1500g (not including paper roll)

1.9 Model classification

Model	Interface
SP-POS88 V SF	RS – 232C Serial Interface
SP-POS88 V PF	Parallel Interface
SP-POS88 V EF	Ethernet Interface
SP-POS88 V UF	USB Interface
SP-POS88VMF	RS – 232C Serial Interface, USB Interface, Ethernet Interface
SP-POS88VBTF	USB Interface, Bluetooth2.0
SP-POS88VBT4F	USB Interface, Bluetooth4.0
SP-POS88VBTi	USB Interface, Bluetooth with MFI certification

Chapter 2 Operation Specification

2.1 Printer Appearance

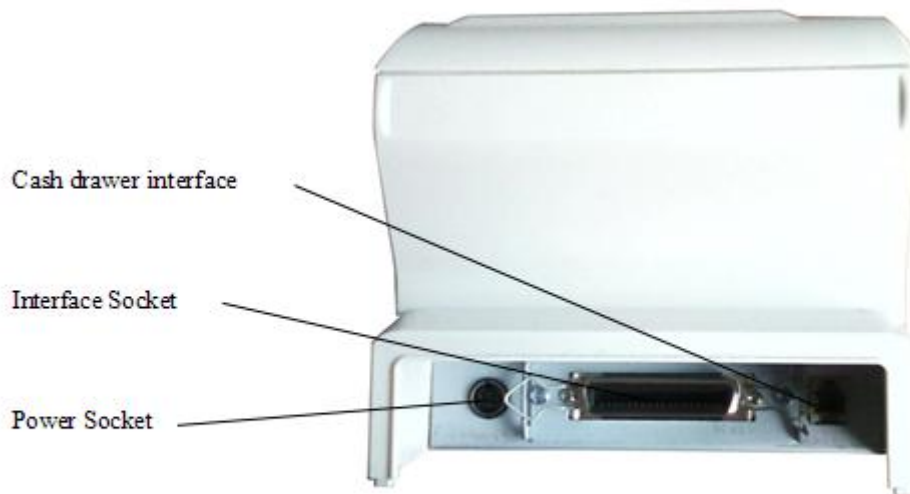
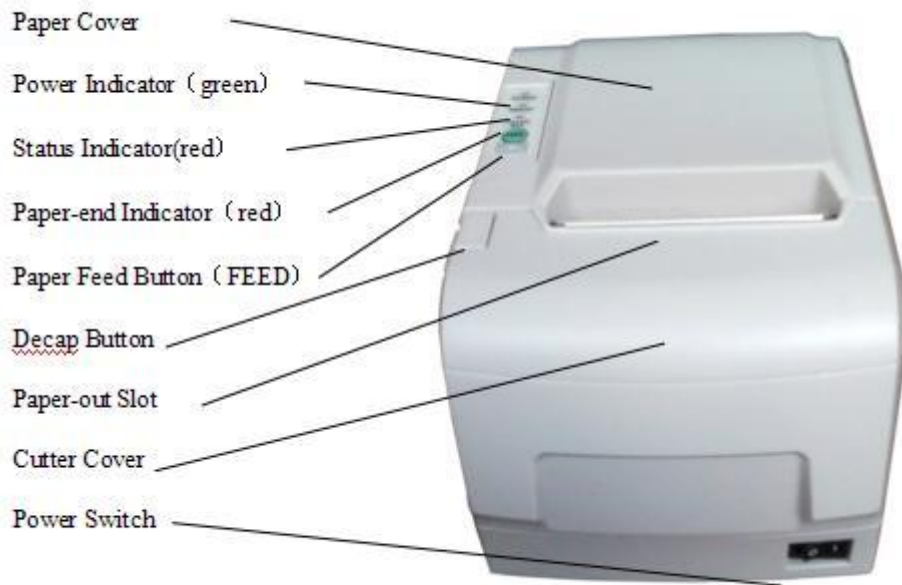

Fig.2-1 Printer Appearance

2.2 Paper Installation

2.2.1 Paper Loading

POS88V adopts 79.5mm width thermal paper roll.

Steps of Loading Thermal Paper Are as below:

Hold down the upper cover button on the left side, open the movable upper cover and put the paper roll into it, draw a certain length of the paper roll, put the paper end on the print head, close the upper cover and press it downwards lightly.



1. Pay attention to the direction of loading paper, make the printing surface face to the print head.
2. Please don't feed or draw the paper forwards or backwards with hands.
3. Keep clean of the print head, avoid to influence the printing quality.

2.2.2 Solution to Paper Jam

If cutter jam, turn off the power, and turn on again, the cutter will be back to original position. If paper jam, open the paper cover, and take out the paper. If the cutter can not be back to the original position, open the cover of it, and turn the white plastic gear by the direction suggestive on the cutter by hand to make the cutter be back to the original position.

2.3 Interface

2.3.1 Serial Interface

The serial interface of SP-POS88V printer is compatible with RS-232C, supports DTR/DSR and XON/XOFF handshaking protocols, uses DB25 socket (female). The pin order of the serial port is as Fig.2-2 shows:

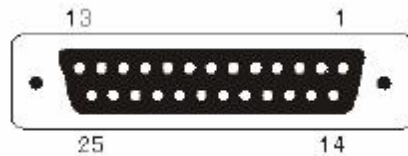

Fig.2-2 Pin Order of Serial Port

The pin assignment of serial interface is shown in Fig. 2-3:

Pin No.	Signal Name	Signal Direction	Source	Description
1	FG	—	—	Cover ground
2	TXD	Output	Printer	Printer transmits control code X-ON/X-OFF and data to host
3	RXD	Input	Host	Printer receives data from host
4	RTS	Output	Printer	The same with 20pins DTR signal
6	DSR	Input	Host	Signal "MARK" means the host is busy and can not receive data. Signal "SPACE" means the host is ready to receive data.
7	GND	—	—	Signal Ground

20	DTR	Output	Printer	Signal "MARK" means the host is busy and can not receive data. Signal "SPACE" means the host is ready to receive data.
----	-----	--------	---------	--

Fig. 2-3 The pin assignment of serial interface

Note: (1) "Source" denotes the source that signal come from;
(2) Logical signal level is EIA.

The baud rate and data structure in serial interface mode is 9600bps, 8-bit data bits, no parity bit and 1 stop bit.

The serial interface of SP-POS88V can be connected to standard RS-232C interface. When it is connected to IBM PC or its compatible machine, connection can accord to Fig.2-4.

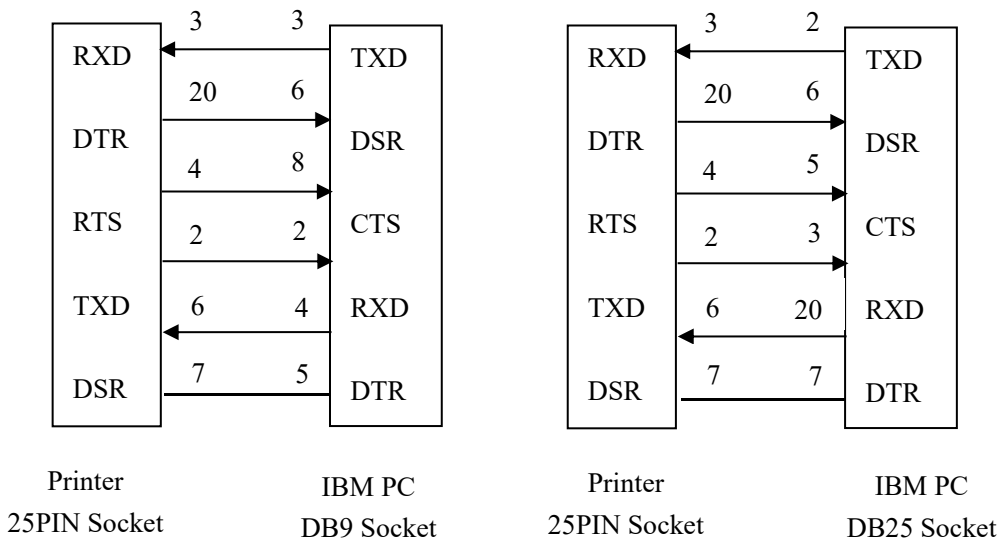
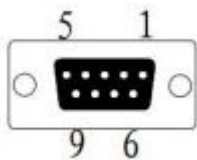

Fig.2-4 Connection between SP-POS88V and IBM PC Serial Interface Sketch Map

The pin assignment of DB9 interface is as below shows:



Pin No.	Signal Name	Source	Description
2	TXD	Printer	Printer transmits control code X-ON/X-OFF and data to host
3	RXD	Host	Printer receives data from host

6	DSR	Printer	The same as CTS
8	CTS	Printer	Signal "MARK" means the host is busy and can not receive data. Signal "SPACE" means the host is ready to receive data.
5	GND		Signal Ground

2.3.2 Parallel Interface

The parallel interface of POS88V printer is compatible with CENTRONICS, supports BUSY or ACK handshaking protocol, which uses 36pin CENTRONICS socket (female)

The pin assignment of DB25 parallel interface is as Fig. 2-5 shows:

Pin No.	Signal	Direction	Description
1	STROBE	In	Strobe pulse to latch data, Reading occurs at falling edge.
2	D1	In	These signals represent the 1st bit to 8th bit of the parallel data respectively ,each signal is at HIGH level when data is logic 1, and LOW when data is logic 0.
3	D2	In	
4	D3	In	
5	D4	In	
6	D5	In	
7	D6	In	

8	D7	In	
9	D8	In	
10	ACK	Out	Answer pulse, low level signal indicates that data have already been received and the printer gets ready to receive the next data.
11	BUSY	Out	HIGH level signal indicates that the printer is BUSY and can not receive data.
12	PE	Out	HIGH level signal indicates that paper is end.
13	SEL	Out	Pulling up to HIGH level signal by a resistor
17	FG	---	Signal Cover
18	Logic-H	---	Logic "1" level
32	nFault	Out	Low level means the printer is at fault
14,15,17 18,34,36	NC	---	No connection
16,19~30, 33	GND	---	Grounding logical 0 level
35	+5V	---	+5V power

Fig.2-5 36Pin assignment of parallel interface

Note: (1)"In" denotes input to the printer,"Out" denotes output from the printer.

(2)Signal level is TTL standard.

The timing chart for interface signal of parallel interface is as Fig.2-6shows:

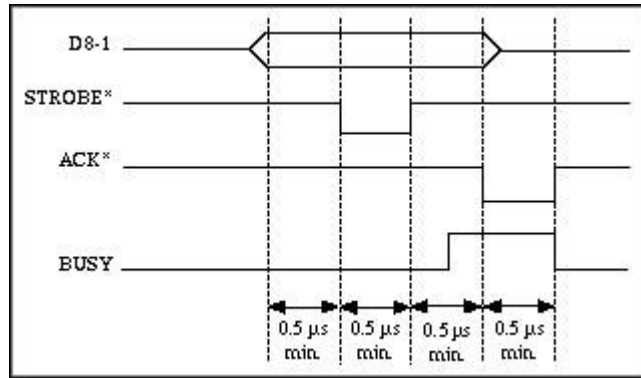

Fig.2-6 Signal Timing Chart of Parallel Interface

2.3.3 Cash Drawer Interface

The cash drawer interface of POS-POS88 V adopts RJ-11 6-pin socket, as Fig.2-7 shows:

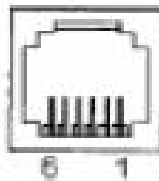

Fig.2-7 Cash Drawer Interface

The pin assignment is as below:

Pin No.	Signal	Direction
1	Chassis Ground	—
2	Cash drawer driver signal 1	Out
3	Cash drawer on/off status signal	In
4	+24VDC	—
5	Cash drawer driver signal 2	Out
6	Signal ground	—

2.3.4 Power Connection

POS88 V uses the external power supply adopter as 24V±10%、2A, power socket is A-1009-3P model, as Fig. 2-10 shows:



Fig.2-8 Power Socket

The pin assignment is as below:

Pin No.	Signal
1	+24VDC
2	Ground
3	NC

2.4 Buttons and Indicators

There is one button and three indicators on POS88 V printer. 【FEED】 is paper feeding button, the function of its enabling or disabling the button on/off can be set by print command, when the button is enabled, press 【FEED】 button, then the paper presenting driver starts up and paper feed into the printer; release 【FEED】 button, paper feeding stops. The green POWER light is the power indicator, red ERROR light is status indicator, it is dark when the printer works normally, while it flashes when reporting an abnormal emergency, as the following form shows:

Error	Indicator and Buzzer Status	Description
Paper ending	“ERROR” indicator flashes	Paper is running out
Print head uplift	Buzzer rings	Put down print head
Print head overheat	Hurried buzzer ring	Recovers automatically when the print head cools.
Auto cutter Position Error	Buzzer rings and indicator blinks	Impossible to recover, check if there is paper jam.

When any error shown above occurs, pin “nFault” of parallel change to “0” level, and send 1 bit wrong code through serial TXD by itself, it can also send out the printer state by answer the ESC v command.

Red indicator of “Paper Out ” is the paper out indicator. When there is no paper in printer head, it will light, and it is off under normal status.

2.5 Self-test

The self-test will check the condition of printer, if the printer prints out the self-test receipt correctly, it means the printer works normally, except interface with host. Otherwise it needs to repair. The self-test will print out 96 ANK characters, default code page, name of Chinese Character library, interface setting and software version.

Way of self-test: hold down **【FEED】** button and turn on the power, self-test begins automatically at this moment.

2.6 Hexadecimal Printing

Turn on the printer according to the step below, it will enter the mode of Hexadecimal Printing.

- 1.Open the cover;
- 2.Hold down **【FEED】** button,and connect with power;
- 3.Close the cover, the printer will print out 3 lines as below:
Hexadecimal Dump
To terminate hexadecimal dump,
Press FEED button three times.

This means the printer has entered hexadecimal printing mode, and under this mode, all of the input will be printed out as hexadecimal number, feed one line with single-click of “FEED” button, after 3 times, it will print out “*** Completed ***”,and exit hexadecimal printing mode.

2.7 Parameter Setting

This function is for the setting of printer parameters.

Steps for setting parameters:

When printer power is off, open paper case cover firstly. Hold the **【FEED】** button, then switch on the printer and release the **【FEED】** when the status indicator and paper-out indicator flash alternately. Then press the **【FEED】** twice and close the paper cover, printer enter the setting mode and print out the first set parameter and its default value. The details method of setting parameter can refer to Appendix A.

Steps for exiting of parameter setup:

Open paper case cover and press the **【FEED】** button; then close paper case cover and release the **【FEED】** button. The printer will save the setup of parameters, exit setting mode and enter the normal working mode.

The data will not be saved if turn off the printer directly.

2.8 Enter the program upgrade mode

When printer is power off, open paper case cover. Hold the **【FEED】** button, then switch on the printer and release the **【FEED】** when the status indicator and paper-out indicator flash alternately. Then press the **【FEED】** for five times and close the paper cover, printer enter the program upgrade mode. At this time, the status indicator flash once a second.

Quick enter method:

Open the paper case cover firstly when printer is power off. Hold the **【FEED】** button and switch on the printer, then release the **【FEED】** button quickly, then printer enter the program upgrade mode. At this time, the status indicator flash once a second.

Appendix A

This appendix is the method to set the printer parameter according to button operation.

Setting introduction: Press **【Paper cover】** button to choose setting, when press it once, the set become the next one and it will print the present set value; use **【FEED】** button to set the set value, when press it once, the set become the next one and it will print the present set value.

General Setting:

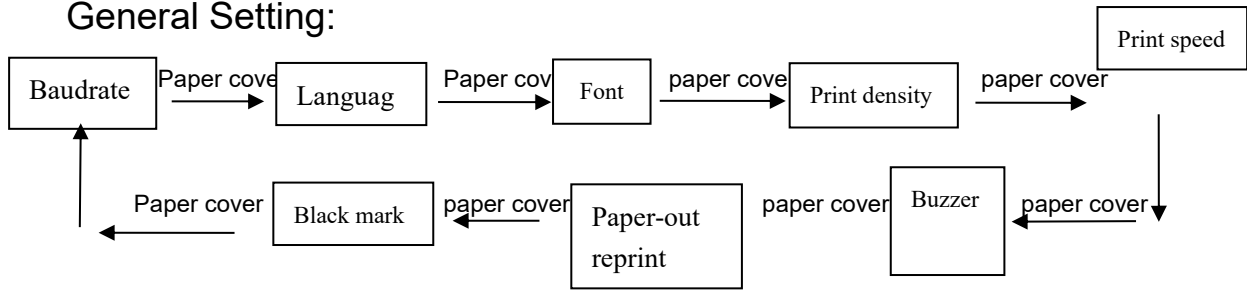

Baud rate:

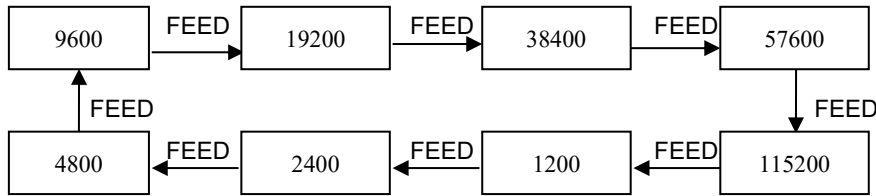

Language:



Font:

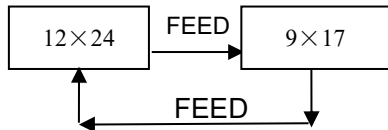

Print density:

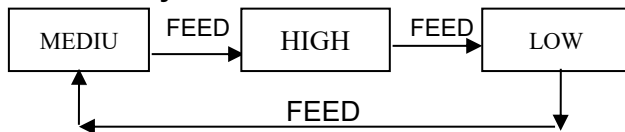

Print speed:

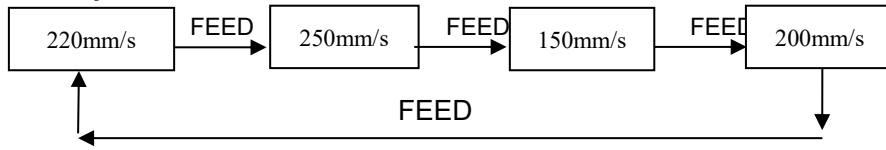

Buzzer:

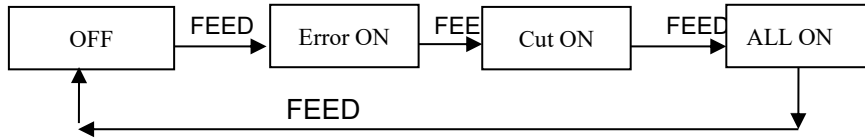

Paper-out reprint:

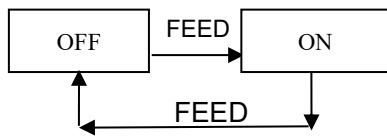

Black mark mode:

