

# Technical proposal for JX-TH-480-20-100M Circulator

## Revision History

Version	Date	Author	Revision description	Comment
V1.0	2018/06/01	Lin liqun	Created	/
				/

## Table of content

Technical proposal for JX-TH-480-20-100M Circulator.....	1
1. Mechanical layout.....	2
2. Electrical specifications .....	2

## Figures

Figure 1 JX-TH-480-20-100M front panel layout.....	2
--	---

## Tables

Table 1 Mechanical Specifications .....	2
Table 2 Electrical specifications.....	2

**JING XIN MICROWAVE TECHNOLOGY CO.,LTD**

E-mail: [sales@cdjx-mw.com](mailto:sales@cdjx-mw.com) Web: <http://www.cdjx-mw.com>

TEL: +86-28-85026087 FAX: +86-28-65941390 Zip Code:610045

Add: No.65,West 1st Wu Ke Road, Wu Hou District, Cheng Du City, Si Chuan Province, China.

## 1. Mechanical layout

Table 1 Mechanical Specifications

Dimension	LxWxH: 38mm x 35mm x11mm
Connectors	Microstrip
Finish	Plated with nickel
Weight	0.23kg
Notes	Material shall be RoHS 6/6

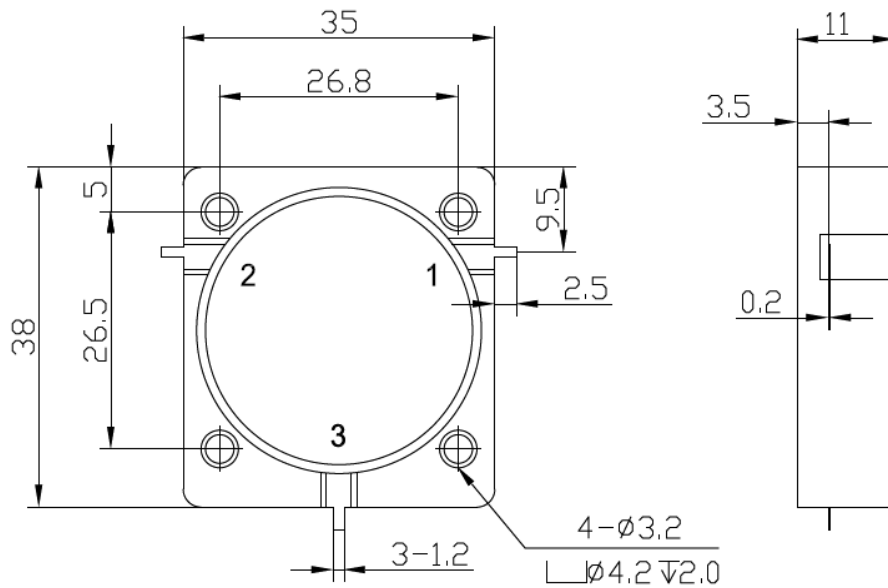

Figure 1 JX-TH-480-20-100M front panel layout

## 2. Electrical specifications

Table 2 Electrical specifications

Item	Parameter	Spec
1	Frequency range	470-490MHz
2	Insertion Loss	≤0.4 dB
3	VSWR	≤1.2
4	Isolation	≥23dB
6	Power	100W
7	Temperature range	-10°C ~ +55°C
9	Impedance all ports	50Ohm

**JING XIN MICROWAVE TECHNOLOGY CO.,LTD**

E-mail: [sales@cdjx-mw.com](mailto:sales@cdjx-mw.com) Web: <http://www.cdjx-mw.com>

TEL: +86-28-85026087 FAX: +86-28-65941390 Zip Code:610045

Add: No.65,West 1st Wu Ke Road, Wu Hou District, Cheng Du City, Si Chuan Province, China.