

## YF07002

7 inch, four-wire resistive touch panel



Disclaimer: The product design is subject to alternation and improvement without prior notice.

## Table of Contents

1 STRUCTURE .....	3
2 GENERAL FEATURES .....	3
3 DIMENSION DRAWING.....	4
4 PIN DEFINITION.....	5
5 OPTICAL CHARACTERISTICS .....	5
6 RELIABILITY CONDITION .....	5
7 APPEARANCE TESTING.....	6
8 PRECAUTIONS FOR USE OF TOUCH SCREEN.....	8
9 TP INTRODUCTION.....	9

## 1 Structure

Structure	Materials	Description
Top Circuit	ITO Film	Thickness: 0.188mm ITO Film with Anti-glare hard coating&Anti-Newton Ring
Bottom Circuit	ITO Glass	Thickness: 1.1mm ITO Glass with Anti-reflection
Tail Type	FPC	Thickness: 0.3mm

## 2 General Features

Item	Description	Unit
Type	Four-Wire Resistive	-
Screen Size	7	inch
Physical Dimension	163.8(W)*97.8(H)*1.50(D)	mm
Active Area	153.68(W)*86.18(H)	mm
Tail Length	80±0.5	mm
Input Method	Press	-
Surface Hardness	3H	-
Life	≥1,000,000 times 150g N	-
Humidity	20%~90% non dew condensation	
Operating Temperature	-20~70	°C
Storage Temperature	-30~80	°C

Note: Compliant with the latest RoHS directive.

### 3 Dimension Drawing

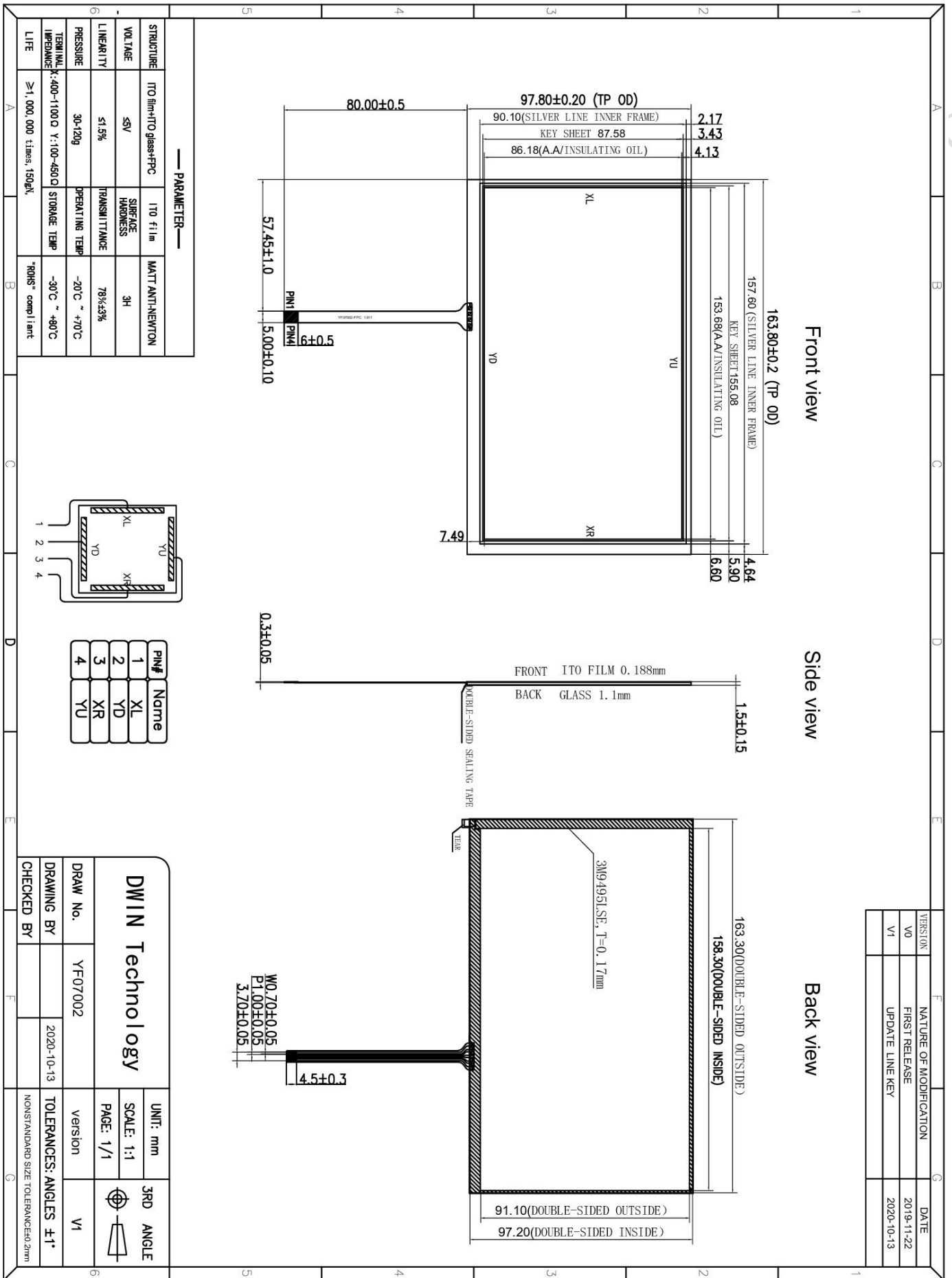

## 4 PIN Definition

PIN	Signal	Description
1	XL	X-(Left)
2	YD	Y-(Down)
3	XR	X-(Right)
4	YU	Y-(Up)

## 5 Optical Characteristics

Item	Value	Remark
Light Transmittance	78% ± 3%	

Note: Light source C-light (Measure point: Center of the point).

## 6 Electrical Property

Item	Value	Remark
Rated Voltage	≤ 5V	
Current	-	
Terminal Impedance	X: 400-1100Ω Y: 100-450Ω	
Linearity	X direction: within ±1.5%	Testing method as Figure 1
	Y direction: within ±1.5%	
Insulation Resistance	DC 25V 20MΩ above	Connect X+~X- and Y+~Y-, apply 25V DC Between X and Y for perform measurements

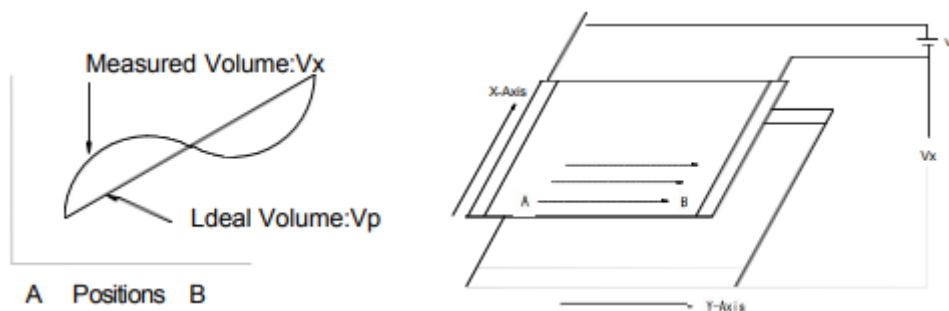

Figure 1

## 7 Appearance testing

### 7.1 Inspection Scope

This standard only applies to the view area. That is, all the appearance of bad, as long as it is outside the visible area, will not affect the product function and are not taken into account; all stains that can be wiped off with a soft cloth with neutral detergent or isopropyl alcohol are not taken into account. Definition of visible area: the area visible to the customer after assembly (generally the front window of the glass). The visible area of the panel includes the front screen-printed border of the panel and the window of the panel.

### 7.2 Inspection Conditions

Healthy adults with visual acuity of 1.0 and above (with glasses or not), under a cool white fluorescent lamp of 20-40W (requiring the illumination of the inspection table between 500~1000 Lux), at a distance of 30-40 cm between the object and the inspector's eyes, and with black and white cardboard below the product as a backdrop, each piece of product inspection time does not exceed 12 seconds. As shown below.

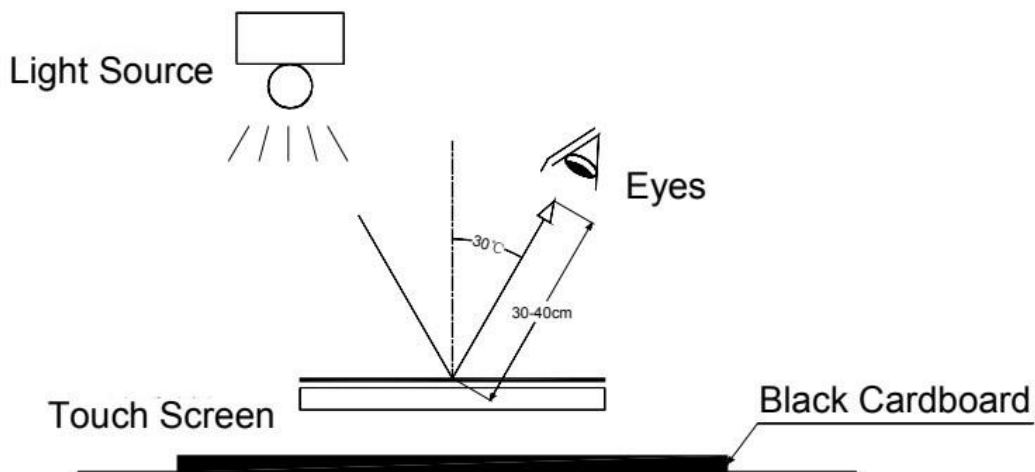

### 7.3 Appearance Defect&Damage

#### View area(cover)

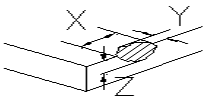
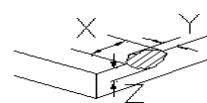
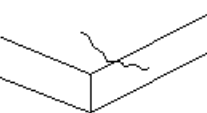
Item	Specifications		Judgment Content	
			View Area	Outside the VA
Spotted Foreign Object	$D \leq 0.25\text{mm}$		Negligible	
	$0.25\text{mm} < D \leq 0.3\text{mm}$		$N \leq 4$ (spacing at least 10MM or more)	Negligible
	$0.3\text{mm} < D \leq 0.35\text{mm}$		$N \leq 3$ (spacing at least 10MM or more)	Negligible
	$D > 0.35\text{mm}$		Fault	Negligible
Linear Foreign Object	$W \leq 0.03\text{mm}$ or $L < 2.0\text{mm}$		Negligible	
	$0.03 < W \leq 0.04\text{mm}$ And $L \leq 3\text{mm}$		$N \leq 4$ (spacing at least 10MM or more)	Negligible
	$0.04 < W \leq 0.05\text{mm}$ And $L \leq 3\text{mm}$		$N \leq 3$ (spacing at least 10MM or more)	Negligible
	$0.05\text{mm} < W$		Judged by the specifications of the punctate foreign body	Negligible
Note: 1. Divide the entire screen into 9 parts 2. Distance between two defects $\geq 5\text{mm}$				
Fragments	Fragments (Surface)	$X \leq 0.5\text{mm}$ , $Y \leq 0.5\text{mm}$ , $Z \leq 1/2$ glass thickness		Negligible
	Fragments (Back)	$X \leq 0.5\text{mm}$ , $Y \leq 0.3\text{mm}$ , $Z \leq 1/2$ glass thickness		Negligible
	Progressive crack			Fault

### 7.4 Other

This datasheet basically informs the product characteristics. You can contact us if you have further requirements.

## 8 Precautions for Use of Touch Screen

### 8.1 Storage

8.1.1 The products should be stored within the storage temperature and humidity range, excluding any external loads.

8.1.2 The products should be stored in a suitable packing box.

8.1.3 Do not expose the product to water, organic solutions or acids for use or storage.

8.1.4 Do not expose the product to direct sunlight.

### 8.2 Unpacking

8.2.1 When you handle the product, hold the product by its body. Do not hold by the FPC tail.

8.2.2 Before opening the box, check the "UP/ DOWN" indicator.

### 8.3 Handling

8.3.1 When you handle the product, do not touch the sensor A.A area to avoid damage to the touch panel.

8.3.2 Please be careful not to exert any pressure on the heat-sealed FPC, heavy pressure may cause malfunction.

8.3.3 Do not depress or scratch the product with any object with a sharp edge to avoid scratch to the product surface.

8.3.4 Do not forcibly bend or fold the product.

8.3.5 Do not put heavy objects on the product.

8.3.6 Clean the product with a soft cloth or that with neutral detergent or alcohol. When contaminated by chemicals, wipe them off immediately with caution to avoid injury to human body.

### 8.4 Mounting

8.4.1 After removing the protective film and re-laminating it to the product surface, make sure the product surface is free of dirt.

8.4.2 When installing the bezel design, try to reduce the pressure of the bezel edge on the touch screen.

8.4.3 The end of the FPC must not be forcefully stressed or excessively bent to avoid conduction in the insulated area and break the wire.



## 9 TP Introduction

### 9.1 Process capacity

DWIN adopts the advanced laser cutting and CNC finishing cover production process in a total of 15,000 square meters of clean workshop, which centralized capacitive touch screen manufacturing of cover, ITO glass, nano-silver film, and back-end lamination. The monthly output of CTP is about 1 million pieces, and the monthly output of RTP is about 500000 pieces.

#### Laser split and finishing integrated molding



#### 100 meters long clean workshop achieving 6-station articulated automatic printing line



#### Automatic cleaning and tempering line



## 9.2 ODM service

Customized sample orders are completed by the prototype line, and sample delivery is shortened to less than 5 days; after the deal is made, the order enters into 24H fully automated production line production, and the OCA lamination yield is up to 99.3% or more in large volume uninterrupted production. The ODM services available are as follows.

### 9.2.1 Form factor

1. Non-conventional size within 0.9~37 inch
2. Circular screen
3. Cover shape: fillet, irregular and chamfer
4. Silkscreen color
5. Logo



Non-conventional size within 0.9~37 inch



Circular screen



Cover shape



Silkscreen color



LOGO

### 9.2.2 Process

1. 2.5D solid
2. Visible in sunlight
3. Optical blinding
4. OCA full lamination
5. GFF ultra-thin

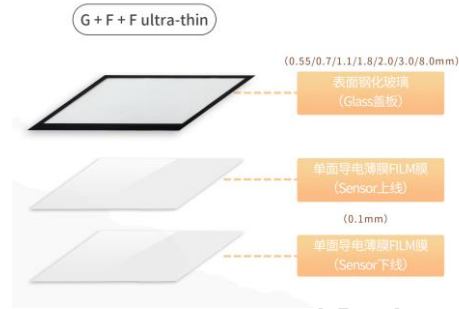
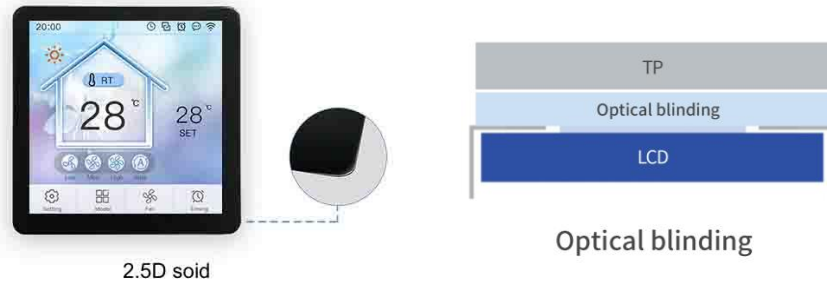

### 9.2.3 Material

1. Anti-UV
2. Anti-fingerprint
3. Anti-glare

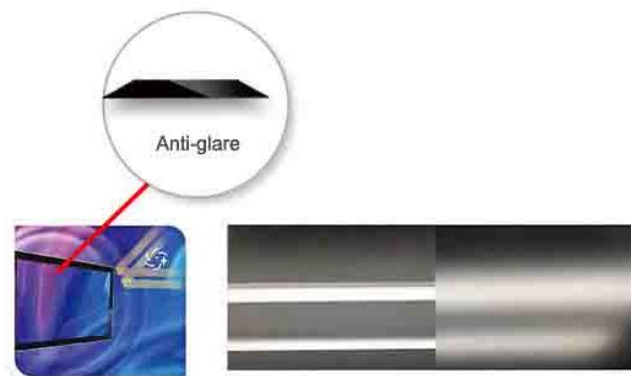
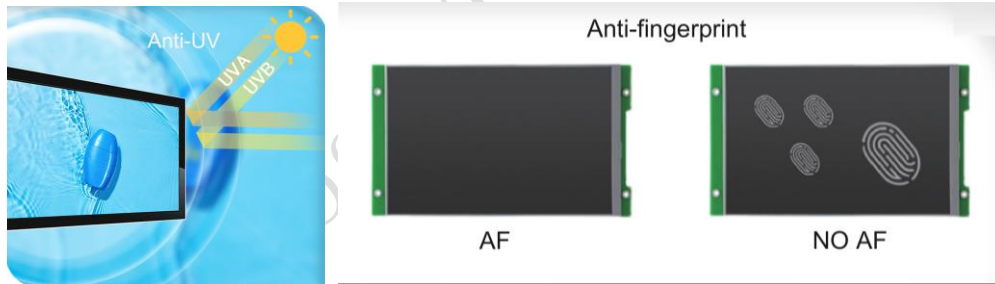

## Record of Revision

Rev	Date	Description	Editor
00	2023-03-31	English Version	Chen Xian

Please contact us if you have any questions about the use of this document or our products, or if you would like to know the latest information about our products:

Customer service tel: + 86 400 018 9008

Customer service email: [dwinhmi@dwin.com.cn](mailto:dwinhmi@dwin.com.cn)

DWIN developer forum: <https://forums.dwin-global.com/index.php/forums/>

Thank you all for continuous support of DWIN, and your approval is the driving force of our progress!