

36W AC-DC Medical-grade Wall-mounted Power Module ADA360K090S001A



1 Features

- Wide input voltage: the input working voltage range is 100-240VAC.
- Low power consumption: No-load <math><0.075\text{W}</math>.
- High Energy Efficiency: Six levels of energy consumption, power efficiency up to 88%.
- High reliability: Comply with EN60601-1 CLASS II safety level and 2×MOPP insulation protection level, and pass CE.
- Flame retardant insulation: UL94V-0 flame retardant heat resistant material.
- Protection types: short circuit protection, over current protection, over voltage protection, and self-recovery.
- Convenient conversion: Adapt to five conversion plugs of British, Australian, European, American, and Chinese.

2 Applications

- Blood glucose meter
- Blood oxygen meter
- COVID-19 PCR test machine
- Household beauty device
- Physiotherapy equipment

3 Description

ADA360K090S001A is a wall-mounted power adapter with a single output. With 100 -240 VAC universal input voltage, it can continuously output any DC voltage of 9VDC. Provides five portable conversion plug options for British, Australian, European, American, and Chinese regulations to meet a variety of external power requirements. widely used in portable medical equipment.

Table of Contents

1	FEATURES	1
2	APPLICATIONS	1
3	DESCRIPTION	1
4	NAMING CONVENTION	3
5	SPECIFICATION	3
5.1	INPUT PARAMETER	3
5.2	OUTPUT PARAMETER	3
5.3	ENVIRONMENT	4
5.4	PROTECTION FUNCTION	4
5.5	RELIABILITY	4
5.6	SAFETY STANDARDS / DIRECTIVES	4
5.7	EMC	5
6	TYPICAL APPLICATION CIRCUIT	5
7	MECHANICAL SPECIFICATION	6
8	PRECAUTIONS FOR USE	8
9	REVISION HISTORY	9

4 Naming Convention

ADA360K090S001A: Output Voltage 9V Rated Power 36W AC / DC medical grade power adapter

□□	Product Code	AD=Isolated AC/DC; DD=Isolated DC/DC
□	Packaging Form	A=adapter; M=resin filled power module; P=PCB module
XXX	Power Coding	First two digits multiplied by 10 to the power of the third digit
□	Application Level	C=commercial grade T=industrial grade K=medical grade S=harsh environment application
XXX	Output Voltage	*10 ⁻¹ V
□	Custom tag	S=standard product Z=customized product
XXX	Product ID	001-999, used to identify different products of the same category
□	Major Upgrade Information	A-Z, fixed as A for the first mass production

5 Specification

5.1 Input Parameter

Voltage Range	100~240 VAC
Frequency Range	47~63Hz
Input Current (Max.)	0.8A @ 115VAC, 0.5A @ 230VAC
Efficiency (Typ.)	88%
Standby Consumption	0.1W
Impulse Current (Typ.)	30A @ 115VAC, 40A @ 230VAC
Leakage Current (Typ.)	0.1mA @ 264VAC, 60Hz

5.2 Output Parameter

Output Voltage	9VDC
Voltage Tolerance	±5%
Output Current	4000mA
Rated Power (Max.)	36W
Line Regulation	±1% at full load
Max. Capacitive Load	7000uF
Load Regulation	±1%
Ripple & Noise	50mV (Typ.), 100mV (Max.)@20MHz
Frequency (Typ.)	65kHz
Hold up Time (Typ.)	15mS @ 100VAC 80mS @ 230VAC

5.3 Environment

Operating Temperature	-40 ~ +70°C
Storage Temperature	-40 ~ +85°C
Storage Humidity	95%RH (Max.)
Power Derating	2.7%/°C @ -40 ~ -25°C 2.4%/°C @ +50 ~ +70°C, 12VDC 2.7%/°C @ +55 ~ +70°C
Temperature Coefficient	±0.02%/°C
Soldering Temperature	260±5°C @ Wave Soldering, 5~10s 360±10°C @ Manual Soldering, 3-5s

5.4 Protection Function

Short Circuit	Long term short circuit, auto recovery.
Over Current	≥140%IO auto recovery
Over Voltage	≤22VDC @ 9V output
IEC Safety Class	CLASSII
Electric Shock Protection	2×MOPP @ primary to secondary

5.5 Reliability

MTBF	≥300000H @ 25°C
------	-----------------

5.6 Safety Standards / Directives

Medical safety	EN60601-1
CE	Compliant
Isolation Voltage (Min.) Input to Output	4000VAC @ 1 minute test and the leakage current is smaller than 5mA.

5.7 EMC

	Parameter	Standard	Test Level / Note
EMI	Conducted emission	EN55011(CISPR11)/EN55032(CISPR32)	CLASS B
	Radiated emission	EN55011(CISPR11)/EN55032(CISPR32)	CLASS B
	Voltage flicker	EN61000-3-2	-
	Harmonic current	EN61000-3-2	-
	Parameter	Standard	Test Level / Note
EMS	Electrostatic Discharge	IEC/EN61000-4-2	$\pm 8\text{KV/Contact}$ $\pm 15\text{KV/Air}$
	Radiate Susceptibility	IEC/EN61000-4-3	10V/m
	Electrical Fast Transient burst	IEC/EN61000-4-4	$\pm 2\text{KV}$
	Surge	IEC/EN61000-4-5	$\pm 1\text{KV}$ Professional/Family medicine
	Conducted Susceptibility	IEC/EN61000-4-6	10Vr.m.s
	Voltage Dips and Interruption	IEC/EN61000-4-11	0%, 70%

6 Typical Application Circuit

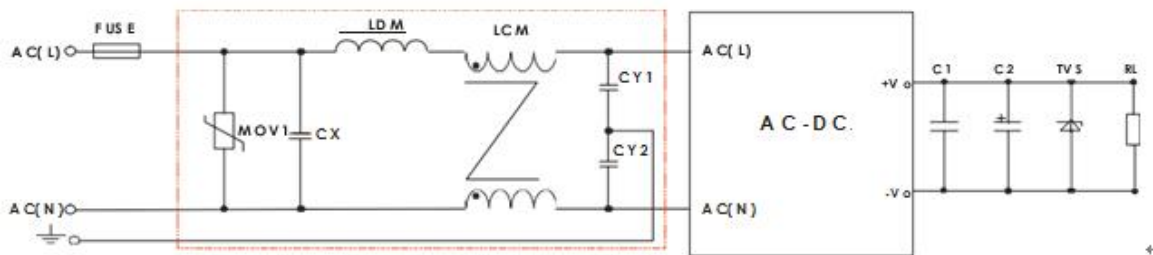

Note: EMC has higher requirements without any additional circuit.

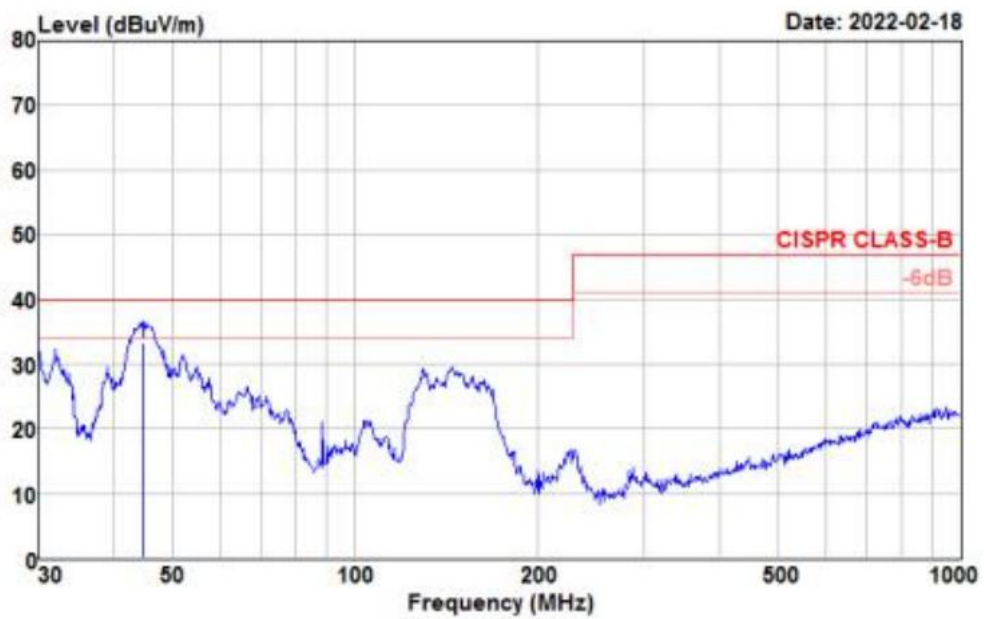
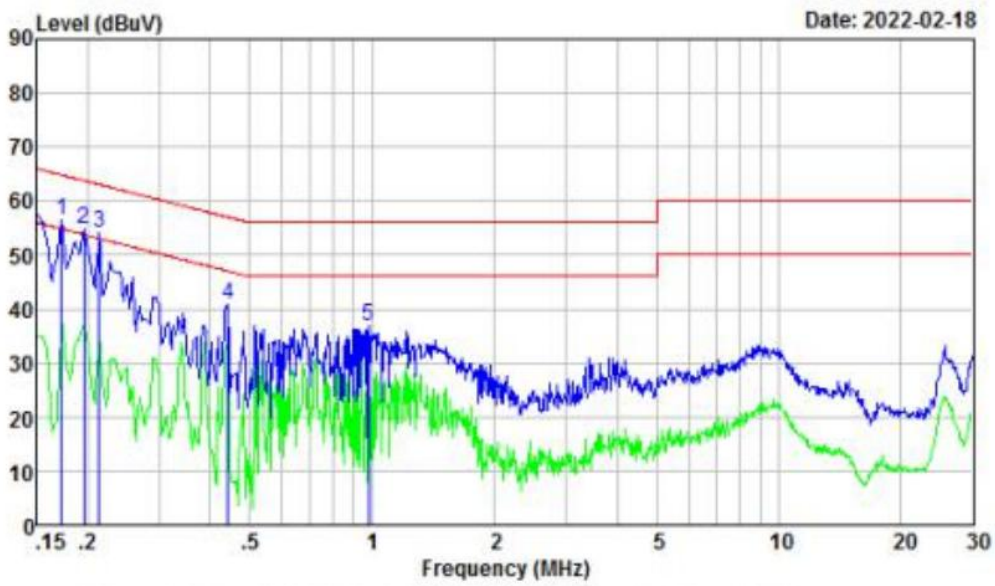
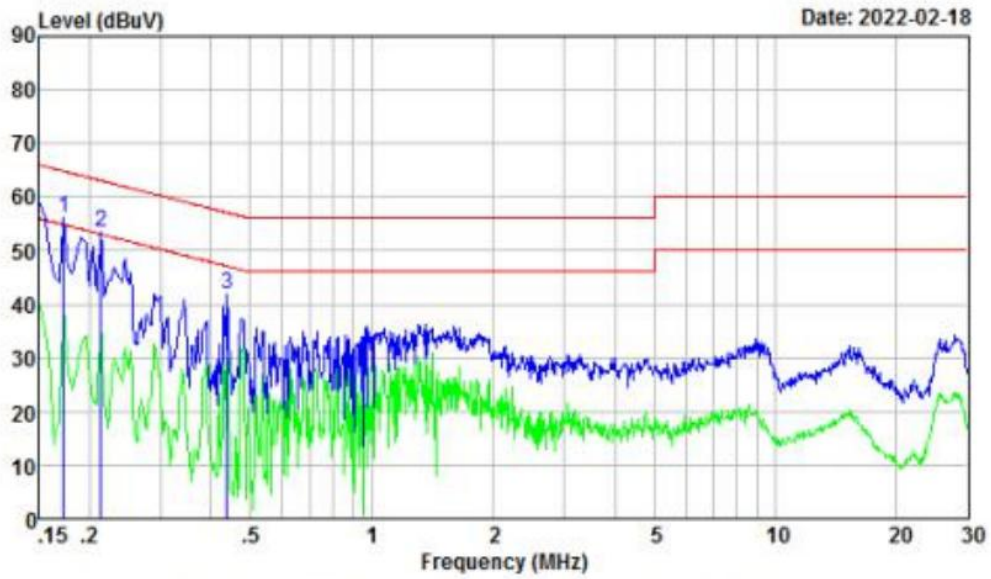

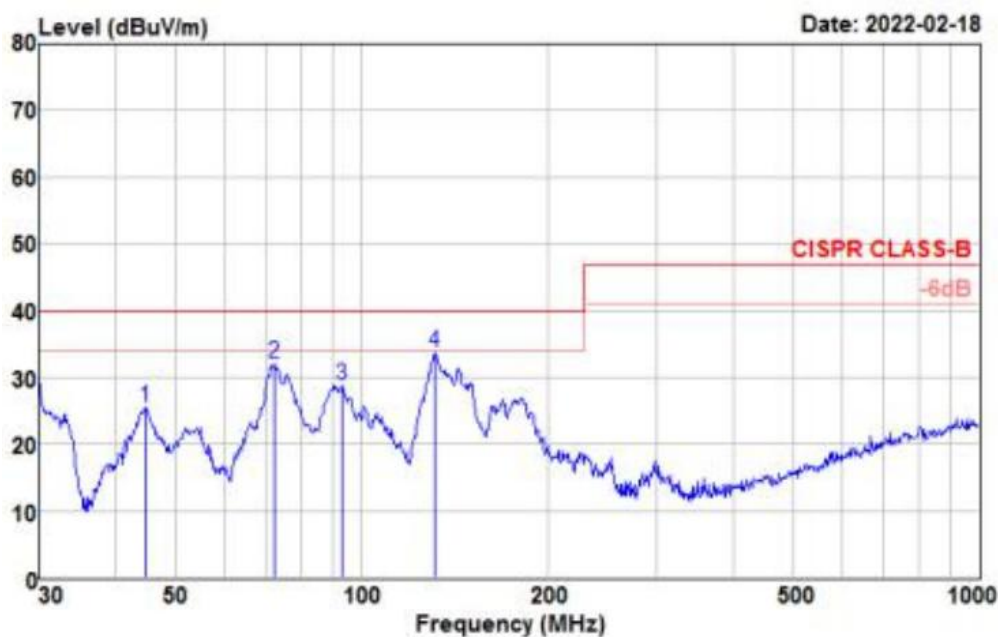





7 Mechanical Specification

Dimension	70*47*48mm
Enclosure Material	Black flame retardant and heat resistant plastics (UL94V-0)
Cooling mode	Natural air cooling
Cooling mode power	ul2464 × 22Awg * 1m, 5.5 * 2.5 straight head + magnetic ring + SR



SWITCHING POWER ADAPTER

MODEL: ADA360K090S001A
 INPUT: 100-240V~ 50/60Hz 0.9A
 OUTPUT: 9V = 4A MAX: 36W



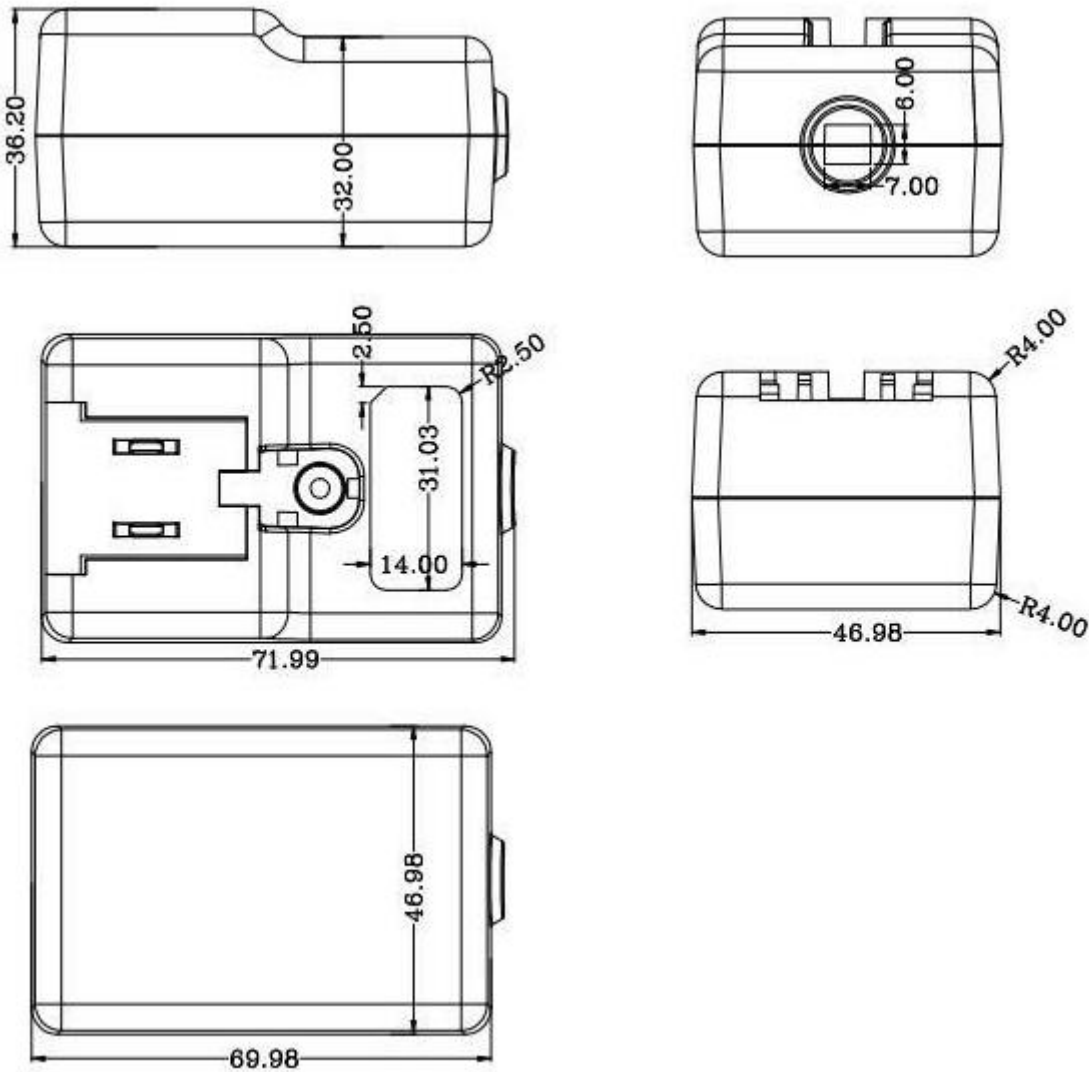

<http://www.dwin.com.cn>
 MADE IN CHINA

- Model No.
- Input Voltage(V)/Frequency/Current(mA)
- Output Voltage(V)/Current(mA)/Max Power
- EU Certification:CE
- Six Levels of Energy Efficiency



8 Precautions for Use

Avoid using the equipment close to or stacked with other equipment, which may lead to improper operation. If it must be used close to or stacked, pay attention to observe and verify the equipment and other equipment to ensure normal operation.

The use of other accessories, sensors and cables provided by the equipment manufacturer may increase the electromagnetic radiation or reduce the immunity.

The distance between the portable radio frequency communication equipment and the equipment should not be greater than 30cm, otherwise the performance of the equipment may be reduced.

9 Revision History

Version	Date	Description	Author
00	2021-04-20	First edition	Kaya
01	2023-05-26	Upgrade version	Kaya

Disclaimer: The product design is subject to alternation and improvement without prior notice.

Please contact us if you have any questions about the use of this document or our products, or if you would like to know the latest information about our products:

- Customer service Tel: +86 400 018 9008
- Customer service email: dwinhmi@dwin.com.cn
- DWIN Developer Forum: <https://forums.dwin-global.com/>

Thank you all for continuous support of DWIN, and your approval is the driving force of our progress!