

# 36W AC-DC Medical-grade Small Package Power Module ADM360K120S001A



## 1 Features

- Wide input voltage: the input working voltage range is 100-240VAC.
- Low power consumption: No-load <math><0.075\text{W}</math>.
- Meet Energy Efficiency Level VI
- High Reliability: Compliant with EN60601-1, IEC CLASS II and 2×MOPP insulation protection level, CE.
- Flame retardant insulation: UL94V-0 flame retardant heat resistant material.
- Full Protections: Short Circuit/ Over Voltage/ Over Current/ Self-recovery.
- Small Size: 65.79\*44.54\*31.49mm, can be put into products with high volume requirements.

## 2 Applications

- Blood glucose meter
- Blood oxygen meter
- COVID-19 PCR test machine
- Household beauty device
- Physiotherapy equipment

## 3 Description

ADM360K120S001A is a medical-grade small package AC-DC switching power supply with a single output. It has the characteristics of low power consumption, broad voltage input, high integration, simple external circuit application, high and low-temperature uniqueness, high efficiency and green, and safe isolation. It adopts 100-240VAC universal input voltages and can continuously output DC of 12V DC Voltage, widely used in portable medical equipment such as blood glucose meters, oximeters, COVID-19 nucleic acid detectors, household medical cosmetology instruments, physiotherapy devices, etc.

## Table of Contents

<b>1</b>	<b>FEATURES</b> .....	<b>1</b>
<b>2</b>	<b>APPLICATIONS</b> .....	<b>1</b>
<b>3</b>	<b>DESCRIPTION</b> .....	<b>1</b>
<b>4</b>	<b>NAMING CONVENTION</b> .....	<b>3</b>
<b>5</b>	<b>SPECIFICATION</b> .....	<b>3</b>
5.1	INPUT PARAMETER .....	3
5.2	OUTPUT PARAMETER .....	4
5.3	ENVIRONMENT .....	4
5.4	PROTECTION FUNCTION .....	4
5.5	RELIABILITY .....	4
5.6	SAFETY STANDARDS / DIRECTIVES .....	5
5.7	EMC .....	5
<b>6</b>	<b>TYPICAL APPLICATION CIRCUIT</b> .....	<b>5</b>
<b>7</b>	<b>MECHANICAL SPECIFICATION</b> .....	<b>7</b>
<b>8</b>	<b>PRECAUTIONS FOR USE</b> .....	<b>8</b>
<b>9</b>	<b>REVISION HISTORY</b> .....	<b>9</b>

## 4 Naming Convention

ADM360K120S001A: medical-grade AC/DC power module with 12V output voltage, 36W rated power and resin filled.

AD	Product Code	AD=Isolated AC/DC; DD=Isolated DC/DC
M	Packaging Form	A=adapter; M=resin filled power module; P=PCB module
360	Power Coding	First two digits multiplied by 10 to the power of the third digit
K	Application Level	C=commercial grade environment application    T=industrial grade    K=medical grade    S=harsh
120	Output Voltage	*10 <sup>-1</sup> V
S	Custom tag	S=standard product    Z=customized product
001	Product ID	001-999, used to identify different products of the same category
A	Major Upgrade Information	A-Z, fixed as A for the first mass production

## 5 Specification

### 5.1 Input Parameter

Voltage Range	100~240 VAC
Frequency Range	50~60Hz
Input Current (Max.)	0.7A @ 115VAC, 0.5A @ 230VAC
Efficiency (Typ.)	89%
Standby Consumption	0.075W
Impulse Current (Typ.)	10A @ 115VAC, 23A @ 230VAC
Leakage Current (Typ.)	0.1mA @ 264VAC, 60Hz

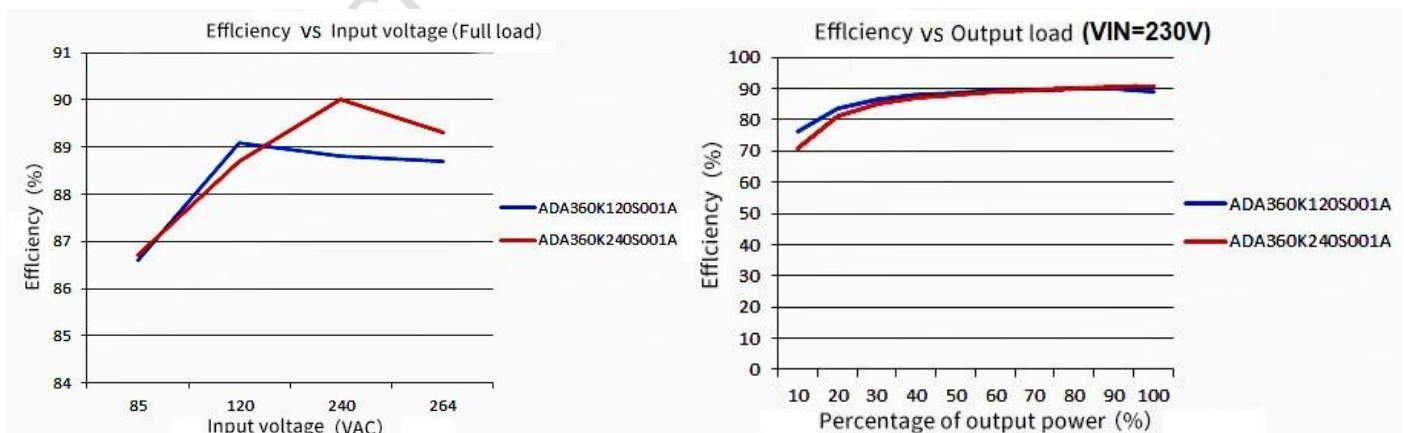

## 5.2 Output Parameter

Output Voltage	12VDC
Voltage Tolerance	±5%
Output Current	3000mA
Rated Power (Max.)	36W
Line Regulation	±0.5% at full load
Max. Capacitive Load	5000uF
Load Regulation	±1%
Ripple & Noise	50mV (Typ.), 100mV (Max.)
Frequency (Typ.)	65kHz
Hold up Time (Typ.)	15mS @ 115VAC 80mS @ 230VAC

## 5.3 Environment

Operating Temperature	-40 ~ +70°C
Storage Temperature	-40 ~ +85°C
Storage Humidity	95%RH (Max.)
Power Derating	2.7%/°C @ -40 ~ -25°C 2.4%/°C @ +50 ~ +70°C, 12VDC 2.7%/°C @ +55 ~ +70°C
Temperature Coefficient	±0.02%/°C
Soldering Temperature	260±5°C @ Wave Soldering, 5~10s 360±10°C @ Manual Soldering, 3-5s

## 5.4 Protection Function

Short Circuit	Long term short circuit, auto recovery.
Over Current	≥130%IO auto recovery
Over Voltage	≤27VDC @ 12V output
IEC Safety Class	CLASSII
Electric Shock Protection	2×MOPP @ primary to secondary

## 5.5 Reliability

MTBF	≥300000H @ 25°C
------	-----------------

## 5.6 Safety Standards / Directives

Medical safety		EN60601-1
CE		Compliant
Isolation Voltage (Min.)	Input to Output	4000VAC @ 1 minute test and the leakage current is smaller than 5mA.

## 5.7 EMC

	Parameter	Standard	Test Level / Note
EMI	Conducted emission	EN55011(CISPR11)/EN55032(CISPR32)	CLASS B
	Radiated emission	EN55011(CISPR11)/EN55032(CISPR32)	CLASS B
	Voltage flicker	EN61000-3-2	-
	Harmonic current	EN61000-3-2	-
		Parameter	Standard
EMS	Electrostatic Discharge	IEC/EN61000-4-2	±8KV/Contact ±2、4、8、15KV/Air
	Radiate Susceptibility	IEC/EN61000-4-3	10V/m
	Electrical Fast Transient burst	IEC/EN61000-4-4	±2 KV
	Surge	IEC/EN61000-4-5	±0.5/±1 KV Professional/Family medicine
	Conducted Susceptibility	IEC/EN61000-4-6	3Vm 0.15MHz-80MHz 6Vm (Within15m band) 0.15MHz-80MHz 80%AM,1kHz
	Voltage Dips and Interruption	IEC/EN61000-4-11	0%UT 0.5cycle 0°, 45°, 90°, 135°, 180°, 270°, 315°. 0%UT 1cycle 70%UT 25/30 cycle 0° 0%UT 250/300 cycle

## 6 Typical Application Circuit

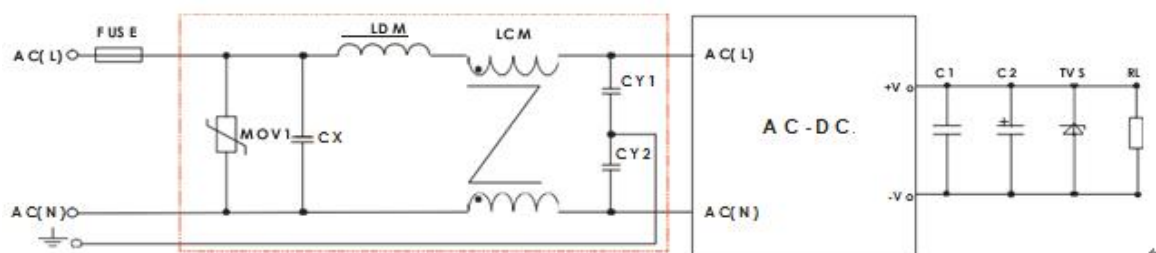

Note: EMC has higher requirements without any additional circuit.

**Pst and limit line**

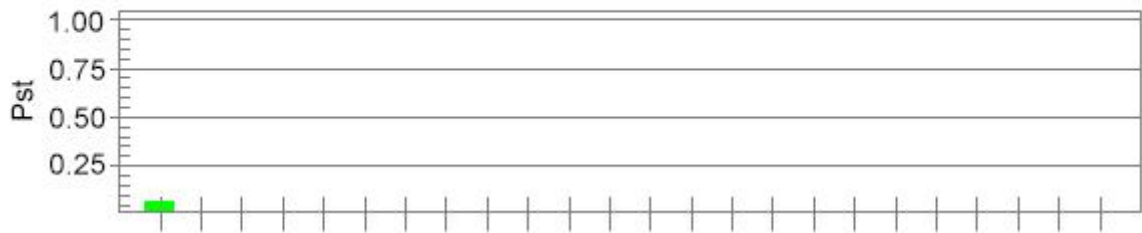

**Plt and limit line**

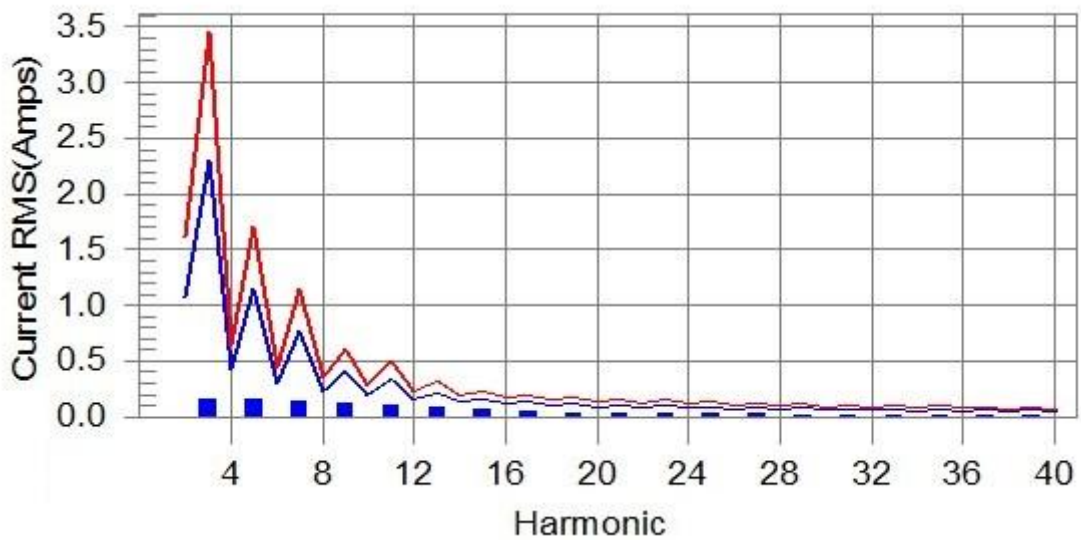
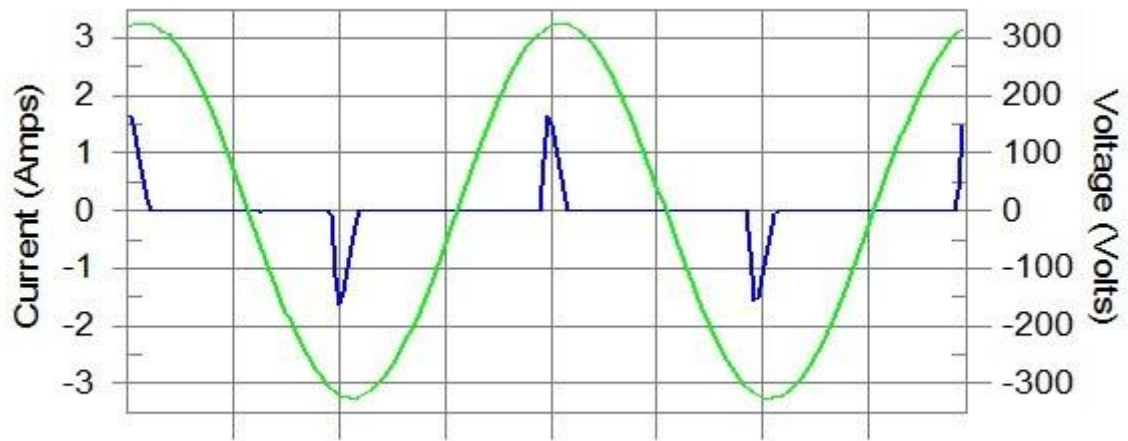
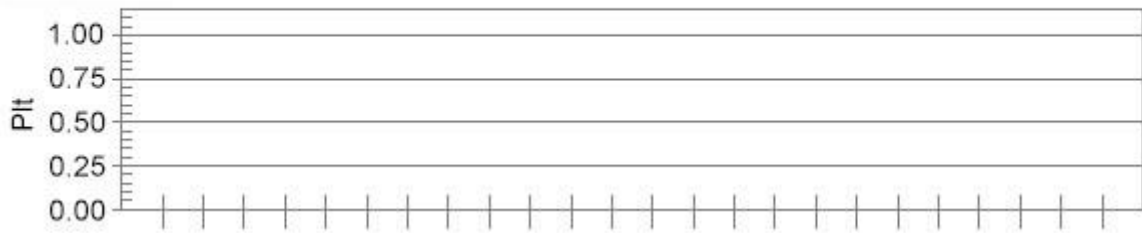

## 7 Mechanical Specification

Dimension	65.79*44.54*31.49mm
Enclosure Material	Black flame retardant and heat resistant plastics (UL94V-0)
Cooling mode	Natural air cooling

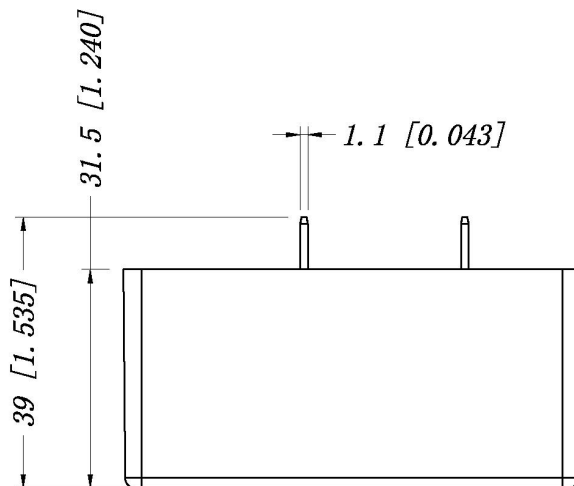
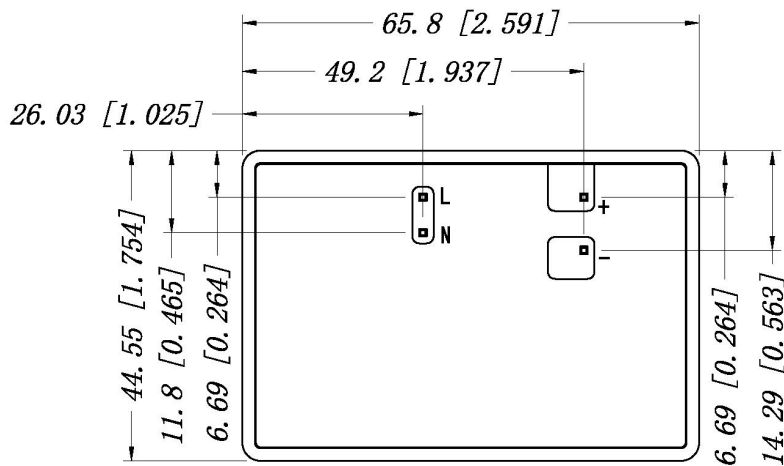
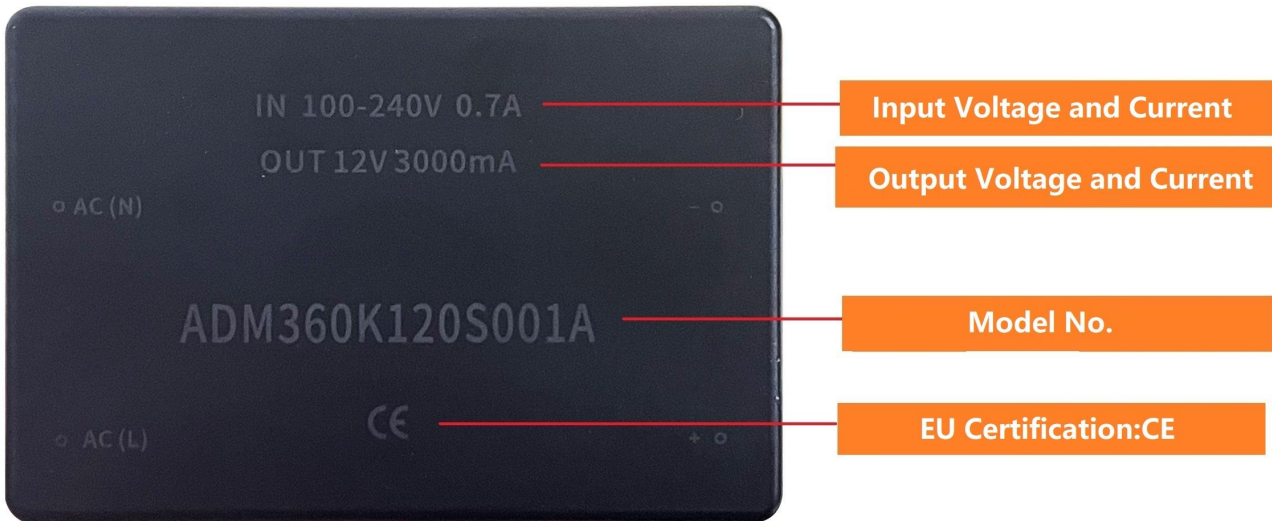

NOTE:

Visual Angel:

Dimension Unit: mm[inch]

Tolerance Not Noted:  $\pm 0.5[\pm 0.020]$



## 8 Precautions for Use

Avoid using the equipment close to or stacked with other equipment, which may lead to improper operation. If it must be used close to or stacked, pay attention to observe and verify the equipment and other equipment to ensure normal operation.

The use of other accessories, sensors and cables provided by the equipment manufacturer may increase the electromagnetic radiation or reduce the immunity.

The distance between the portable radio frequency communication equipment and the equipment should not be greater than 30cm, otherwise the performance of the equipment may be reduced.



## 9 Revision History

Version	Date	Description	Author
00	2021-04-20	First edition	Kaya
01	2023-05-19	Upgrade version	Kaya

Disclaimer: The product design is subject to alternation and improvement without prior notice.

Please contact us if you have any questions about the use of this document or our products, or if you would like to know the latest information about our products:

- Customer service Tel: +86 400 018 9008
- Customer service email: [dwinhmi@dwin.com.cn](mailto:dwinhmi@dwin.com.cn)
- DWIN Developer Forum: <https://forums.dwin-global.com/>

Thank you all for continuous support of DWIN, and your approval is the driving force of our progress!